



LED Recessed Downlight

Installation instruction for 3" Retrofit LED

WARNING : These products may represent a possible shock or fire hazard if improperly installed or attached in any way. Products should be installed in accordance with these instructions, current electrical codes and/or the current National Electric code (NEC).

CAUTION – To reduce risk of fire, electric shock or injury to persons:

1. Make sure that the electrical power to the fixture is disconnected prior to any installation or retrofit.
2. This light is suitable for damp, wet locations.
3. Use with 3" recessed cans (recessed housing) only. Do not attempt to alter for other sizes or purposes.
4. For best dimming results, use standard incandescent wall dimmers in a branch circuit that is supplied with 120V AC power. Check dimmer manufacturer's specifications to confirm whether minimum loads apply.

WARNING : Risk of fire or electric shock. Install these kits only in luminaires that have the construction features and dimensions shown in the illustrations here in(3" recessed housings) Confirm this before installation by checking the interior of the housing for a manufacturer's part number and specifications; or measure the diameter of the housing. The recessed housing must have a minimum measured inside diameter (opening) of 3^{1/4} "; maximum diameter 3^{1/2} "; minimum inside clearance of 3^{3/4} ".

See Figure 1.

Do not make or alter any open holes in a wiring enclosure nor in any electrical components during kit installation!

WARNING : Risk of fire or electric shock. Kit installation requires knowledge of recessed lighting luminaires electrical systems. If not qualified, do not attempt installation. Contact a qualified electrician.

Do not use these products in luminaires located where elevated ambient temperatures exist.

WARNING : Risk of fire or electric shock. The electrical rating of this product is 120V Ac. The installer must determine whether power supply is 120V AC at the luminaire before installation.

(120V/277V Ac 50~60Hz is available if 120V/277V is indicated on caution label)

WARNING : Risk of fire or electric shock. Luminaire's wiring, ballast(s), or other electrical parts may be damaged when drilling for installation of reflector kit hardware. If drilling is required in any installation, check for enclosed wiring and components and be careful to protect them from any harm. To prevent wiring damage or abrasion, do not expose wiring to edges of sheet metal or other sharp objects.

THIS PRODUCT MUST BE INSTALLED IN ACCORDANCE WITH THE APPLICABLE INSTALLATION CODE BY A PERSON FAMILIAR WITH THE CONSTRUCTION AND OPERATION OF THE PRODUCT AND THE HAZARDS INVOLVED.

Each fixture includes a socket adapter for use with a standard 120V medium (E26) base socket adapter, a pair of torsion spring clips. See Figure 1

RETROFIT INSTALLATION

1. Always make sure power to fixtures is disconnected before beginning removal of existing trim or retrofit installation.
2. Remove existing lamp, trim, socket plate from housing.
3. Disconnect the orange colored connector on fixture (FIG 2).
4. Assemble E26 socket adapter to existing socket come down from housing.
5. Connect the orange colored connector on fixture.
6. Push fixture gently to ceiling until seated (FIG 3).



Figure 1.

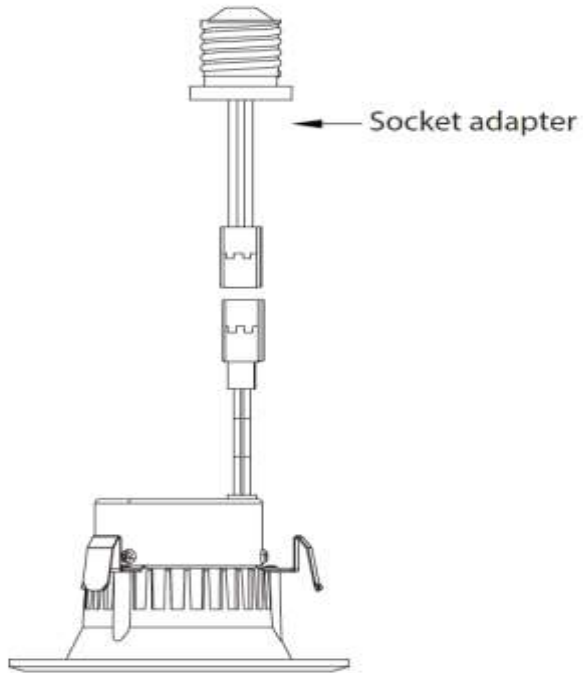

Figure 2.

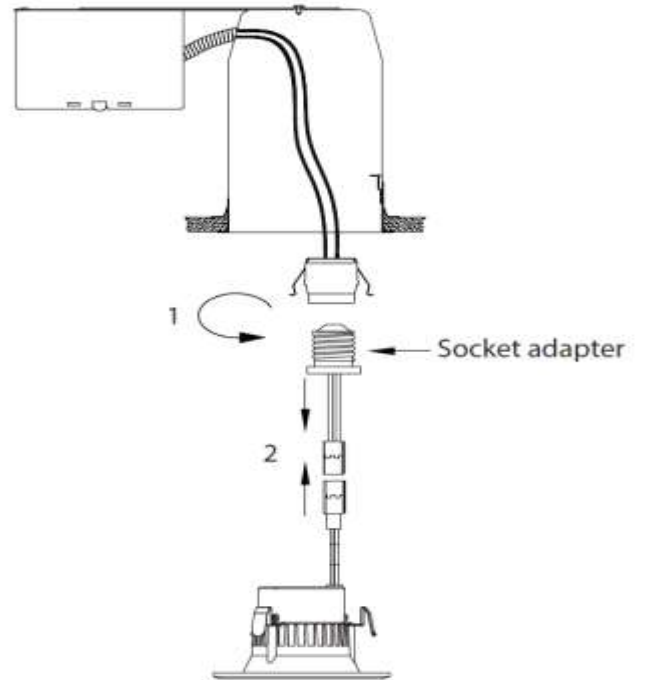

Figure 3.

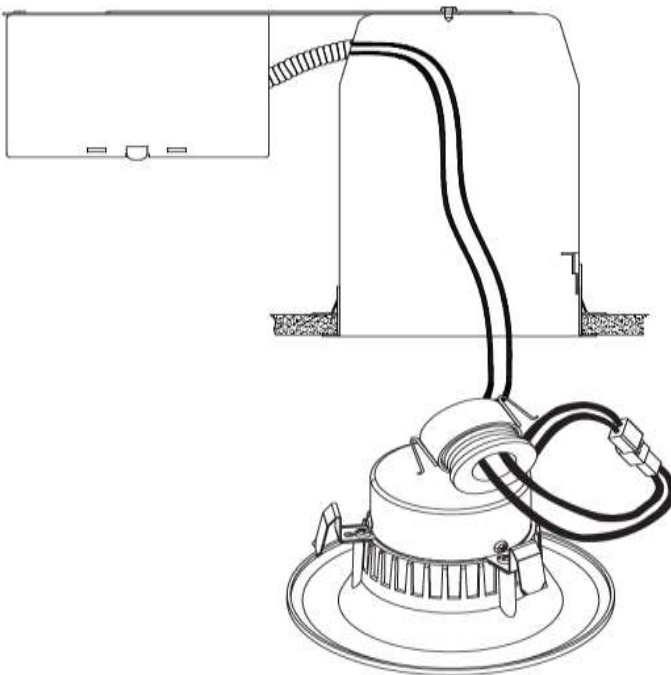

Figure 4.

