

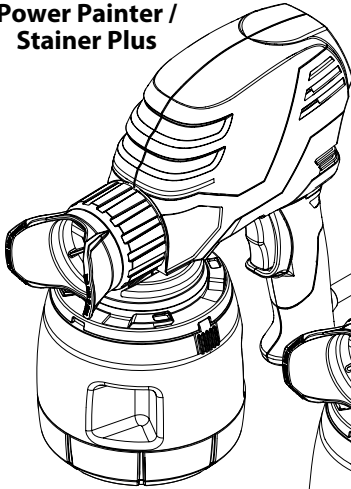

EZ TILT™

**Power Painter /
Stainer Plus**



**Power Painter
Max**

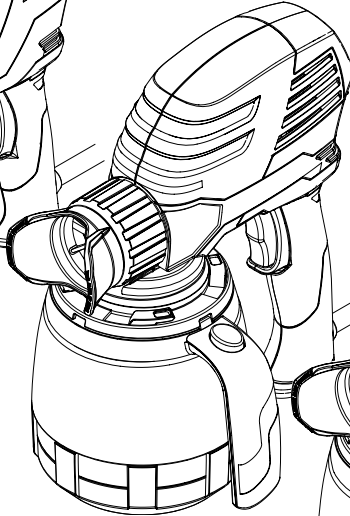

**Power Painter
Pro**

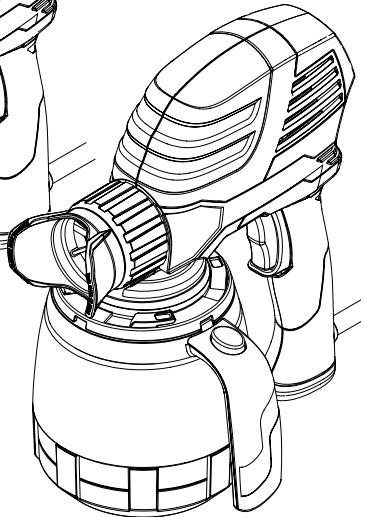

Contents

- 2 Important Safety Information
- 4 Before You Begin
- 5 Features
- 6 Cup Mode Setup
- 7 Remote Suction Hoses Setup
- 8 Backpack Kit Setup
- 9 Spray Controls
- 11 Priming with the Remote Suction Hoses
- 12 Practice Spraying
- 13 Spraying Technique
- 14 Cleanup
- 17 Reassembly / Maintenance
- 18 Troubleshooting
- 20 Replacement Parts
- 61 Repacking Diagram
- 62 Parts List
- 64 Warranty

Questions?

Call Wagner Technical Service at:

1-800-328-8251

Register your product online at:

www.wagnerspraytech.com

Important Safety Information



Read all safety information before operating the equipment. Save these instructions.



Indicates a hazardous situation which, if not avoided, could result in death or serious injury.

To reduce the risks of fire or explosion, electrical shock and the injury to persons, read and understand all instructions included in this manual. Be familiar with the controls and proper usage of the equipment.



WARNING - To reduce the risk of fire or explosion:

1. Do not spray flammable or combustible materials near an open flame, pilot lights or sources of ignition such as hot objects, cigarettes, motors, electrical equipment and electrical appliances. Avoid creating sparks from connecting and disconnecting power cords.
2. For use with only water-based or mineral spirit-type materials with a minimum flash point of 21°C (70° F) — Do not spray or clean with liquids having a flash point of less than 21°C (70° F). Flash point is the temperature at which a fluid can produce enough vapor to ignite.
3. Verify that all containers and collection systems are grounded to prevent static discharge.
4. Connect to a grounded outlet and use grounded extension cords (electric models only). Do not use a 3 to 2 adapter.
5. Do not use a paint or solvent containing halogenated hydrocarbons. Such as chlorine, bleach mildewcide, methylene chloride and trichloroethane. They are not compatible with aluminum. Contact the coating supplier about compatibility of material with aluminum.
6. Keep spray area well ventilated. Keep a good supply of fresh air moving through the area to keep the air within the spray area free from accumulation of flammable vapors. Keep pump assembly in well ventilated area. Do not spray pump assembly.
7. Do not smoke in the spray area.
8. Do not operate light switches, engines, or similar spark producing products in the spray area.
9. Keep area clean and free of paint or solvent containers, rags, and other flammable materials.
10. Know the contents of the paint and solvents being sprayed. Read all Material Safety Data Sheets (MSDS) and container labels provided with the paints and solvents. Follow the paint and solvent manufacture's safety instructions.
11. Fire extinguisher equipment shall be present and working.

Grounding Instructions

This product must be grounded. In the event of an electrical short circuit, grounding reduces the risk of electric shock by providing an escape wire for the electric current. This product is equipped with a cord having a grounding wire with an appropriate grounding plug. The plug must be plugged into an outlet that is properly installed and grounded in accordance with all local codes and ordinances.



WARNING - Improper installation of the grounding plug can result in a risk of electrical shock.

If repair or replacement of the cord or plug is necessary, do not connect the green grounding wire to either flat blade terminal. The wire with insulation having a green outer surface with or without yellow stripes is the grounding wire and must be connected to the grounding pin.

Check with a qualified electrician or serviceman if the grounding instructions are not completely understood, or if you are in doubt as to whether the product is properly grounded. Do not modify the plug provided. If the plug will not fit the outlet, have the proper outlet installed by a qualified electrician.

This product is for use on a nominal 120 volt circuit and has a grounding plug that looks like the plug illustrated below. Make sure that the product is connected to an outlet having the same configuration as the plug. No adapter should be used with this product.

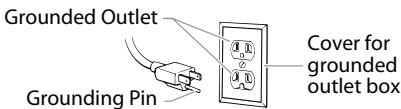

Important Safety Information



WARNING - To reduce the risk of skin injection:

1. Do not aim the gun at, or spray any person or animal.
2. Keep hands and other body parts away from the discharge. For example, do not try to stop leaks with any part of the body.
3. Always use the nozzle tip guard. Do not spray without the nozzle tip guard in place.
4. Only use a nozzle tip specified by the manufacturer.
5. Use caution when cleaning and changing nozzle tips.
6. High-pressure spray is able to inject toxins into the body and cause serious bodily injury. In the event that injection occurs, seek medical attention immediately.
7. This system is capable of producing 2800 PSI / 193 Bar. Only use replacement parts or accessories that are specified by the manufacturer and that are rated a minimum of 2800 PSI. This includes spray tips, nozzle guards and extensions.
8. Verify that all connections are secure before operating the unit.



WARNING - To reduce the risk of injury:

1. Always wear appropriate gloves, eye protection, clothing and a respirator or mask when painting. Hazardous vapors – Paints, solvents, insecticides, and other materials can be harmful if inhaled or come in contact with body. Vapors can cause severe nausea, fainting or poisoning.
2. Do not operate or spray near children. Keep children away from equipment at all times.
3. Do not overreach or stand on an unstable support. Keep effective footing and balance at all times.
4. Stay alert and watch what you are doing.
5. Do not operate the unit when fatigued or under the influence of drugs or alcohol.



WARNING - To reduce the risk of electric shock:

1. Keep electrical cord plug and spray gun trigger free from paint and other liquids. Never hold cord at plug connections to support cord. Failure to observe may result in an electrical shock.
2. Never immerse electrical parts in water or any other liquid. Wipe the exterior of the sprayer with a damp cloth for cleaning. Always make sure the sprayer is unplugged before taking it apart for cleaning.

Important Electrical Information

Use only a 3-wire extension cord that has a 3-blade grounding plug and a 3-slot receptacle that will accept the plug on the product. Make sure your extension cord is in good condition. When using an extension cord, be sure to use one heavy enough to carry the current your product will draw. An undersized cord will cause a drop in line voltage resulting in loss of power and overheating. A 14 gauge or 12 gauge cord is recommended. If an extension cord is to be used outdoors, it must be marked with the suffix W-A after the cord type designation. For example, a designation of SJTW-A would indicate that the cord would be appropriate for outdoor use.

Wagner Spray Tech accessory extension cords recommended:

P/N 0090241	20 foot extension cord
P/N 0090242	35 foot extension cord

IMPORTANT: Household use only. Intended for indoor/outdoor use ONLY with materials having flashpoint above 70°F (21°C).

Capability:

Sprays a variety of paints (oil-based and latex), primers, stains, preservatives and other nonabrasive materials. Do not use materials with flash points below 70° F (21° C).

Do not use!

This pump should not be used with textured materials, block filler, lacquers, industrial enamels, or asphalt sealer or materials containing HHC. See coating supplier if flash point is not listed on the container.

Before you Begin

This page contains information that is necessary in order to operate the sprayer properly.

Material Preparation:

- It is important to mix the material thoroughly before you begin. Do not shake the material to mix it. Always stir the material gently but thoroughly before use.
- Remove any skin that has formed on the top of the material. Do not mix the skin into the material. The skin can break up and clog the sprayer. Older materials may need to be strained.

Thinning the Material:

- Always test spraying without thinning the material as thinning is not typically required.
- If you are spraying with a material that needs to be thinned, make sure to follow the manufacturer's recommendations.

Material That Can Be Sprayed:

- Make sure the type of material you use can be cleaned with either mineral spirits (for oil-based paints) or a warm water and soap solution (for latex paints).

Determining Job Size:

The size of your spray job will determine how the spray gun is set up. The spray gun can operate in three different modes:

- 1) **cup mode** for small to medium jobs (see page 6)
- 2) **remote suction hose mode** for medium to large jobs (if equipped, see page 7)
- 3) **backpack mode** for large jobs that require increased mobility (if equipped, see page 8)

Overspray:

Some sprayed materials create a cloud of paint. Some of that cloud will spray past your intended object and also bounce off of it. Wind and air currents may cause this cloud to drift onto surfaces not intended to be sprayed. You can control the amount of overspray and bounce-back by adjusting your spray controls and moving the sprayer closer to the work piece, but always make sure that you have a good spray pattern. Always test your pattern on a scrap piece of wood or cardboard, and make sure that you have drop cloths protecting anything not being sprayed.

Anything you don't want painted that is in the area of your spraying surface should be covered or removed.

Drop Cloths:

Be sure to protect your floors and furnishings with drop cloths or other coverings during spraying and cleanup.

Spray Tip:

The spray tip included with your Power Painter comes equipped with Optimus™ dual-orifice technology. It is ideal for spraying both water-based and oil-based paints and stains. The Optimus™ spray tip eliminates the need to have different spray tips for different spray materials.

Notice:

The spray gun you have purchased will have some or all of the features and accessories shown here. Refer to the graphic, right, and the chart, below.

Features		Plus	Max	Pro
a	Adjustable spray tip assembly	✓	✓	✓
a1	Tip nut	✓	✓	✓
a2	Spray adjustment guard	✓	✓	✓
b	1 quart cup	✓		
c	1 1/2 quart cup		✓	✓
d	Cup release button	✓	✓	✓
e	Cup grip	✓		
f	Cup handle		✓	✓
g	Trigger	✓	✓	✓
h	Material select lever	✓	✓	
i	Electronic material selector			✓
j	Electronic speed control		✓	✓
k	Low cup level indicator		✓	✓
l	Remote suction hose kit		✓	✓
m	Fill lid adapter (for threaded containers)		✓	✓
n	Fill lid (standard containers)	✓	✓	✓
o	Cleaning brushes, cleaner nozzle and lubricant	✓	✓	✓
p	Backpack kit			✓

Features

Note: Some of the graphics in this manual may not exactly match your sprayer. All information and instructions given in this manual applies to all models except where noted.

**Power Painter /
Stainer Plus**

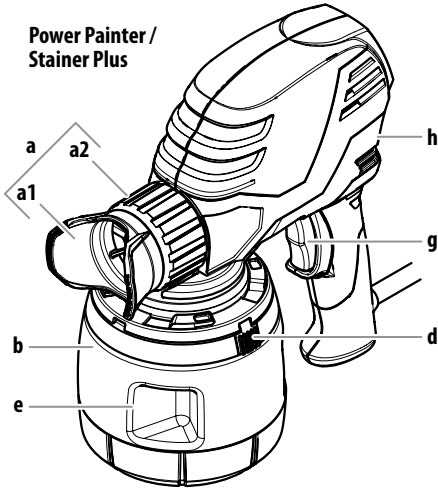

**Power Painter
Pro**

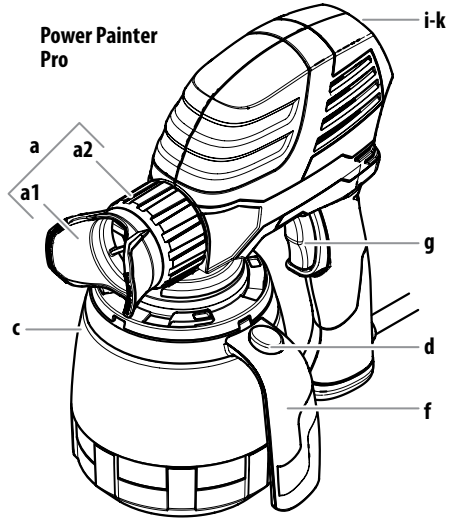

**Power Painter
Max**

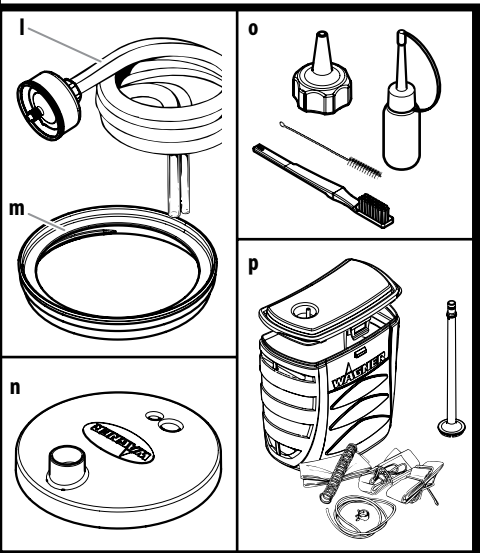
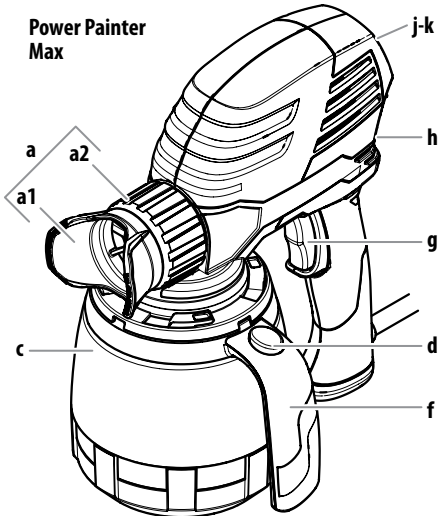

Cup Mode Setup

Recommended for small to medium jobs

The cup will give you approximately 3-5 minutes of continuous spraying time depending upon the cup size.

IMPORTANT: Avoid running the cup dry. An empty cup will allow air to become sucked into the sprayer, which leads to globbing and spitting.

IMPORTANT: Always make sure the tip nut is tightened securely prior to spraying.

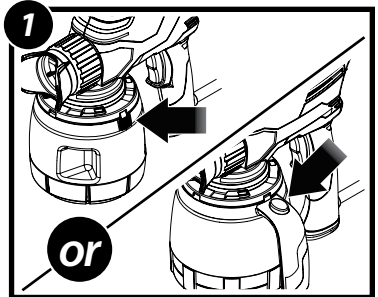
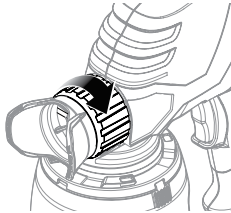

Cup Mode Setup:

1. **Remove the cup** - Press and hold cup release button.
2. Turn cup to release. Remove cup.
3. Attach fill lid to the paint container for easier pouring.
4. Fill the cup.

Note: Fill right up to, but do not exceed, the MAX FILL line.

5. **Replace the cup.** Line up the tabs / slots.

Note: The cup grip / cup handle can be oriented on either side of the sprayer, depending upon your preference.

6. Turn cup to lock.

Note: The cup should "click" back into place.

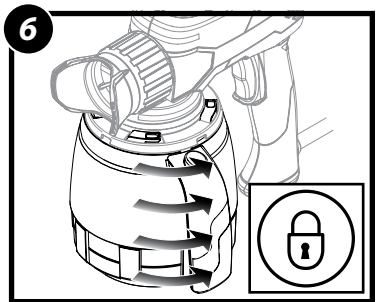
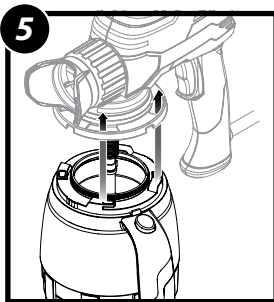
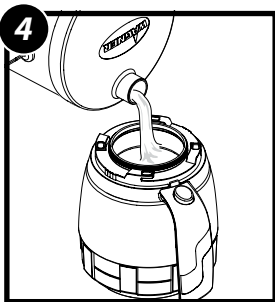
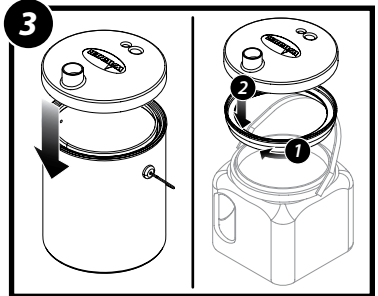
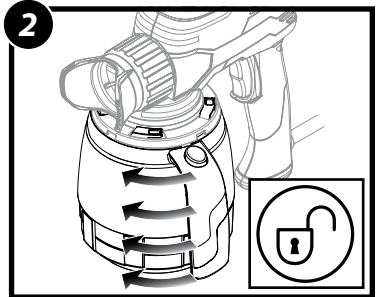

Remote Suction Hose Setup (optional)

Recommended for medium to large jobs

A 75% duty cycle is recommended when spraying with the remote suction hoses. For example, trigger the gun for 15 seconds, and then allow the gun to remain idle (untriggered) for 5 seconds.

IMPORTANT: Avoid running the container dry. An empty container will allow air to get sucked into the sprayer, which leads to globbing and spitting.

IMPORTANT: Always make sure the tip nut is tightened securely prior to spraying.

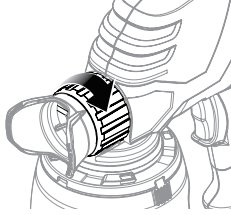

Remote Suction Hose Setup:

1. **Remove the cup -**
See steps 1-2, previous page.
2. Twist and remove the suction tube and filter assembly.
3. Attach the housing to the bottom of the sprayer as shown.
Rotate the housing until it clicks into place.
4. Attach lid to paint container.
Push hoses through the holes in the lid and down to the bottom of the material container.

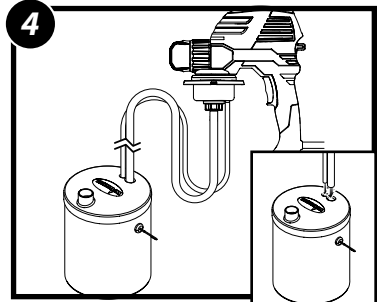
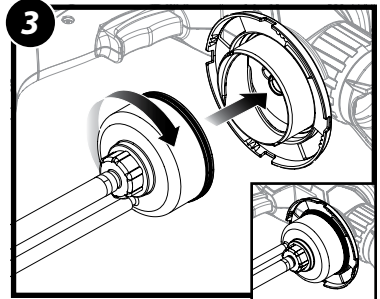
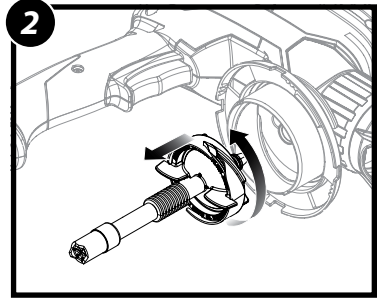
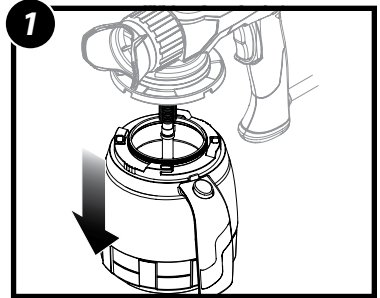

Backpack Kit Setup (optional)

Recommended for medium to large jobs

A 75% duty cycle is recommended when spraying with the remote suction hoses. For example, trigger the gun for 15 seconds, and then allow the gun to remain idle (untriggered) for 5 seconds.

IMPORTANT: Avoid running the backpack dry. An empty backpack will allow air to get sucked into the sprayer, which leads to globbing and spitting.

IMPORTANT: Always make sure the tip nut is tightened securely prior to spraying.

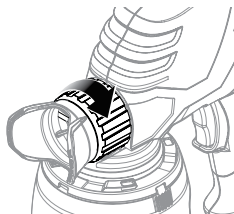

Backpack Kit Setup:

1. Lay cord seal (a) in backpack lid groove (b). Overlap the ends of the cord seal by approximately 1/2 inch. Cut off remaining seal.
Lift seal and butt edges together and press excess seal into groove.
2. Snap backpack suction tube (c) through hole in bottom of backpack lid.
Assemble backpack kit as shown.
3. Secure clip onto suction tube (d).
When backpack kit is assembled, follow steps 1-5 in **Remote Suction Hose Setup** (previous page) to attach the kit to the sprayer.
4. Assemble strap hooks to container using same hole as lid clip. Adjust strap to fit user.
If you want to use a backpack liner, install as shown.
5. Pour material into backpack to fill line. Do not fill above the indicated fill line (e).
6. Place lid on backpack and press firmly into place. Secure with the tabs (f).
7. Backpack can either be back- or shoulder-mounted as shown. Adjust straps to fit user.

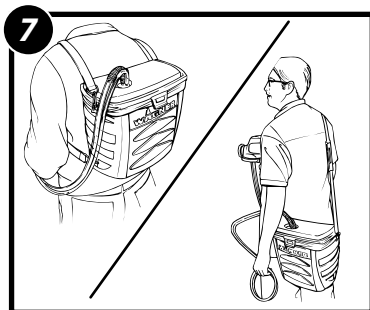
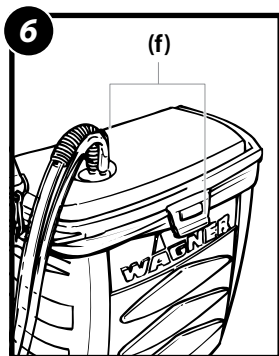
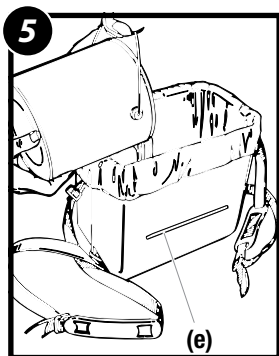
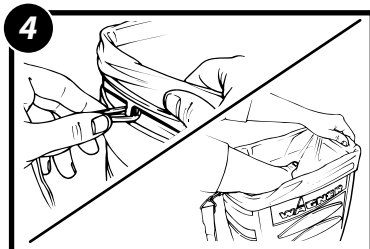
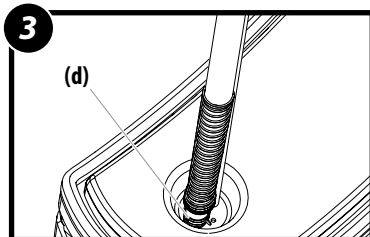
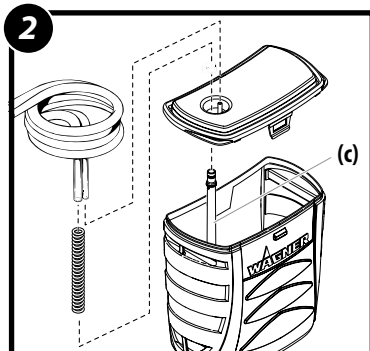
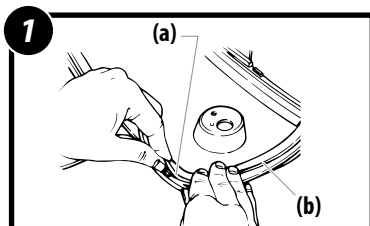

Spray Controls (Plus / Max)

The spray controls vary depending upon the model of sprayer you have. Refer to this page in order to learn about the controls of your particular sprayer.

Power Painter / Stainer Plus

Material Select Lever:

The spray pattern is controlled by the Material Select Lever on the rear of the sprayer, and by the thickness of the material being sprayed.

If you are spraying thicker materials, turn the lever toward the "PAINT" side of the sprayer.

If you are spraying thinner materials such as thinner stains, turn the lever toward the "STAIN" side of the sprayer.

Note: If you are unable to achieve a good spray pattern while using the 'STAIN' setting, switch the lever over to 'PAINT'.

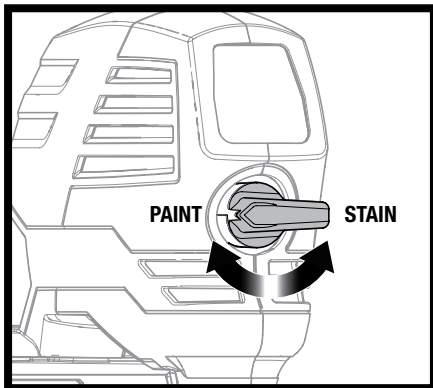

Power Painter Max

Material Select Lever:

Refer to the information given in the previous column.

Electronic Speed Control:

The electronic speed control is displayed by the two green lights on the **right** side of the control panel (a).

The Power Painter Max offers two speed levels (LO / HI). The lower the speed level, the closer you can get to your work and the less overspray you will have.

Lower speed levels give you greater control but require more time to cover an area. Depending upon the thickness of the material or conditions, the settings may need to be adjusted.

To adjust the speed setting, press the 'speed' button (b) below the speed indicator lights until your desired speed is reached.

Low Cup Level Indicator

- Applicable only when spraying in cup mode, cup filled to MAX FILL.
- The low cup level indicator is displayed by the two red lights on the **left** of the control panel (c).

When your cup is running out of material, the low cup level indicators will begin blinking. You should quit spraying and refill the container (see **Cup Mode Setup** instructions, page 6). **Avoid running the cup dry. An empty cup will allow air to become sucked into the sprayer, which leads to globbing and spitting.**

Note: Before you resume spraying, **press and hold** the 'SPEED' button (b) and the indicators will reset and no longer blink. ALWAYS reset the indicators when the cup is full and you are ready to resume spraying. Failure to reset the low cup level indicators will result in the indicators not functioning properly. The low cup level lights will reset whenever the power cord is unplugged.

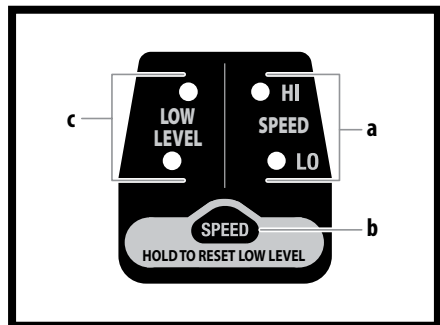

Spray Controls (Pro)

Power Painter Pro

Electronic Material Selector:

The spray pattern is controlled by the Electronic Material Selector (a) and by the thickness of the material.

If you are spraying thicker materials such as latex paint, press the 'Select' button (b) until the indicator light indicates 'paint'.

If you are spraying thinner materials such as thinner stains, press the 'Select' button (b) until the indicator light indicates 'STAIN'.

Electronic Speed Control:

The speed control is displayed by the three green lights on the **upper right** side of the control panel (c).

The Power Painter Pro offers three speed levels (LOW/MED/HIGH). The lower the speed level, the closer you can get to your work and the less overspray you will have.

Lower speed levels give you greater control but require more time to cover an area. Depending upon the thickness of the material or conditions, the settings may need to be adjusted.

To adjust the speed setting, press the 'SPEED' button (d) until your desired speed is reached. If the sprayer is unplugged, the current speed and electronic material selector setting will be "stored" and remembered during restart.

Low Cup Level Indicator

- Applicable only when spraying in cup mode, cup filled to MAX FILL.
- The low cup level indicator is displayed by the two red lights on the **bottom right** of the control panel (e).

When your cup is running out of material, the low cup level indicators will begin blinking. You should quit spraying and refill the container (see **Cup Mode Setup** instructions, page 6). **Avoid running the cup dry. An empty cup will allow air to become sucked into the sprayer, which leads to globbing and spitting.**

Note: Before you resume spraying, press and hold the 'Reset' button (f) and the indicators will reset and no longer blink. Always reset the indicators when the cup is full and you are ready to resume spraying. Failure to reset the low cup level indicators will result in the indicators not functioning properly. The low cup level lights will reset whenever the power cord is unplugged.

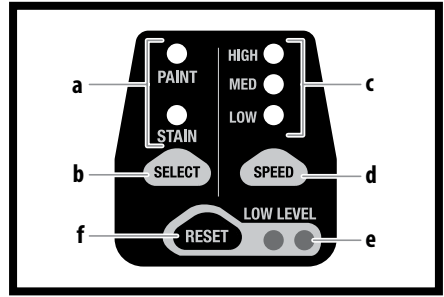

Priming with the Remote Suction Hoses

Follow these steps if you plan to spray while using the remote suction hoses or the backpack kit.

- The time needed to prime will vary from 30 seconds to 3 minutes depending upon the thickness of the material you are spraying.
- If your sprayer is properly cleaned and oiled and it takes longer than three minutes to prime, your piston and/or pump housing may be worn and will need to be replaced before using your remote suction set.
- Using the remote suction hoses will decrease the material flow, so it will take longer to apply the same amount of material to the surface being sprayed.
- A 75% duty cycle is recommended when using the remote suction set. For example, trigger the gun for 15 seconds, and then allow the gun to remain idle (untriggered) for 5 seconds.

IMPORTANT: Always make sure the tip nut is tightened securely prior to spraying.

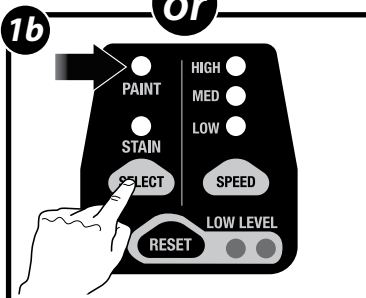
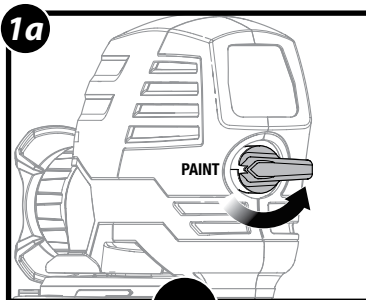
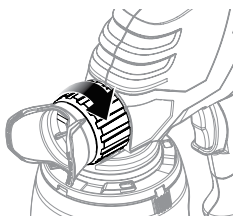

Priming with the Remote Suction Hoses:

- 1a. **If equipped -**
Turn the material select lever to 'PAINT'.
- 1b. **If equipped -**
Press the 'SELECT' switch until the light indicates 'PAINT'.
2. Hold the sprayer **even** with the level of the paint. This will speed up the priming.
3. Aim the sprayer at a piece of scrap wood or cardboard. Squeeze the trigger and hold until all air is out of the system and material is flowing freely out of the sprayer tip. This could take up to three minutes.

IMPORTANT: The suction hose must remain completely submerged in the material. If it is not completely submerged and air is sucked into the system, the piston could seize.

If the piston seizes, the sound the gun makes will change to a low hum and the gun will quickly become hot to the touch. Never run the sprayer when the piston is seized.

Should this happen, clean the piston and the pump housing thoroughly using the cleanup procedures found in this manual.

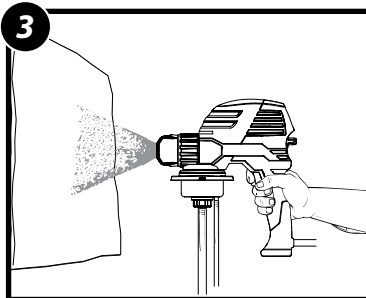
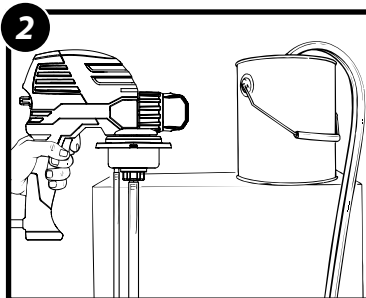

Practice Spraying

You will need:

- a scrap piece of wood or cardboard

IMPORTANT - read before spraying

Priming the Sprayer

Once you are ready to spray, it may take 20 seconds for material to spray after you pull the trigger.

The sprayer may sound choppy, while at the same time spit or spray large globs briefly prior to the spray coming out in a fine mist. This is normal.

Keep holding the trigger and material will come from the sprayer in a fine mist.

Practice Spraying:

1. Turn the material select lever toward "PAINT", or . . .
Press the 'SELECT' switch until the light indicates 'PAINT'.

Note: The "PAINT" setting will allow the sprayer to prime faster.

2. **If equipped -**
Set the speed control to the highest setting.
3. Point the sprayer at a scrap piece of wood or cardboard, and pull the trigger (approximately 10 seconds) until material sprays evenly from the spray gun.
4. **If equipped -**
Adjust the material selector as needed to achieve a good spray pattern.
5. **If equipped -**
Adjust the material selector **and** speed control as needed to achieve the desired spray pattern.
6. (a) - Bad spray pattern.
(b) - Good spray pattern.

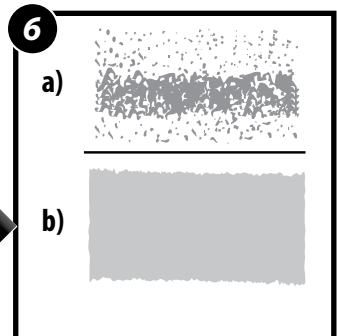
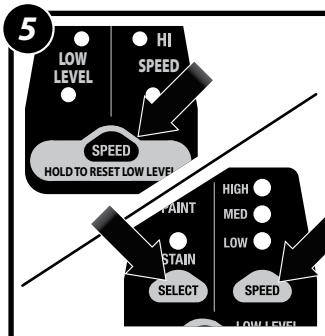
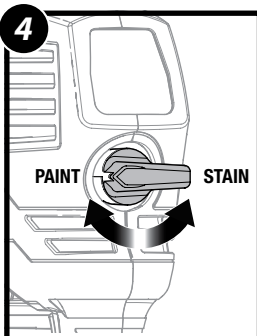
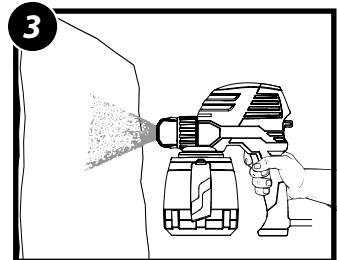
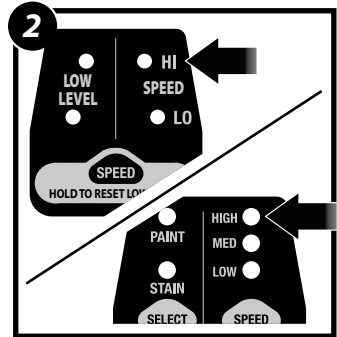
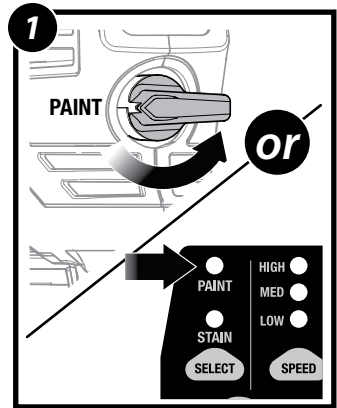

Spraying Technique

Adjusting the spray tip assembly:

The adjustable spray tip assembly produces a pattern that can be adjusted horizontally or vertically. Rotate the spray adjustment guard (b) as shown.



To prevent an injection hazard, make sure the sprayer is unplugged before you adjust the spray tip. Make sure the spray tip nut (a) is sufficiently hand tightened prior to spraying.

Spraying horizontally (side to side):

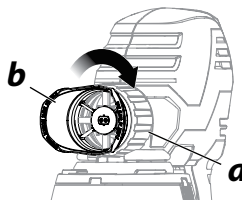

Spraying vertically (up and down):

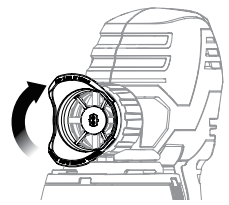

Spraying Technique

Keep your arm moving at constant speed and keep the sprayer at a constant distance from the surface. The sprayer should be triggered at the beginning of the stroke and released at the end of the stroke.

***Note:** Slower speeds (if equipped) will allow you to get closer to the spray surface.

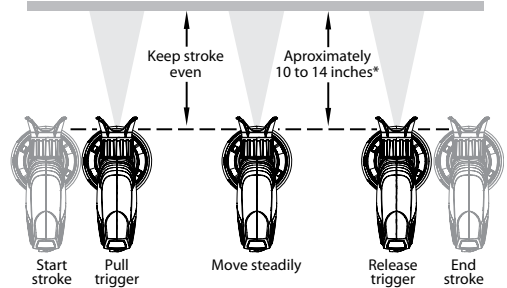

Keep the sprayer at a consistent distance to the surface. This means moving your entire arm back and forth rather than just flexing your wrist. Overlap each stroke by 50%.

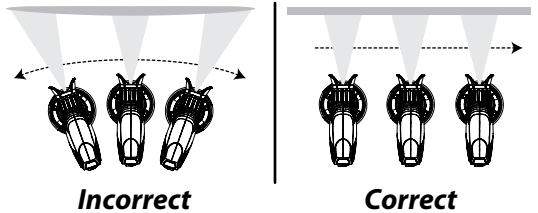

IMPORTANT: If a large amount of material is leaking from behind the adjustable spray tip assembly, turn off the sprayer immediately or the sprayer could be damaged. The sprayer will leak from behind the adjustable spray tip assembly if the tip nut is not tightened firmly. If you notice material leaking from this area, follow the steps below.

1. **Unplug the sprayer immediately.**
Remove the adjustable spray tip assembly.

Note: Remove the adjustable spray tip assembly by turning the spray tip nut (a), **not** the spray adjustment guard (b).

2. Remove the atomizer valve and see if it needs to be cleaned or replaced (see page 20).
Also check the pump housing opening for any dirt or other obstruction and clean if necessary.
3. Put the atomizer valve back in place, making sure it can seat properly without any obstruction.
Thread on the adjustable spray tip assembly by turning the tip nut clockwise and tighten firmly by hand.

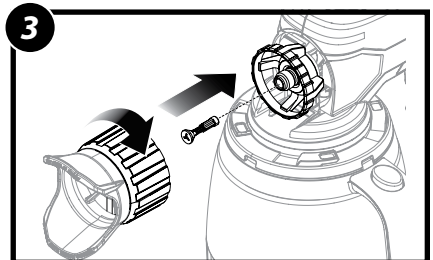
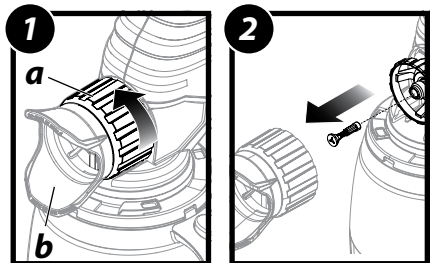

Cleanup (cup mode)

You will need:

- Waste container
- Cleaner nozzle and lubricant
- Warm soapy water if you sprayed latex materials
- Mineral spirits if you sprayed oil-based materials



Make sure you clean the sprayer in a well-ventilated area whenever cleaning with flammable solvents.



The sprayer contains electrical parts. DO NOT submerge the sprayer into any liquids.

Cleanup (cup mode):

1. Unplug the sprayer. Pour the remaining material back into the original container.
Rinse the inside of the cup with the appropriate cleaning solution.
2. Remove the suction tube and filter assembly.
3. Disassemble the suction tube and filter assembly.

Note: The threads on the bottom housing (a) are left-handed. You will need to turn the bottom housing to the **right** in order to remove it.

4. Turn the tip nut counter-clockwise and remove the adjustable spray tip assembly.
Pull the atomizer valve out, being careful not to lose it.
5. Turn the locking nut counterclockwise until it is removed.
6. Slide the pump housing off the sprayer.
7. Remove the spring and piston from the pump assembly.

(continued on next page)

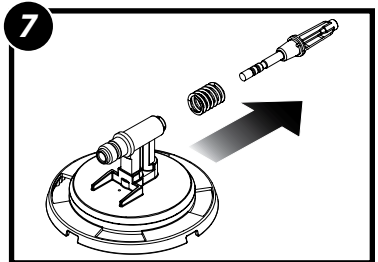
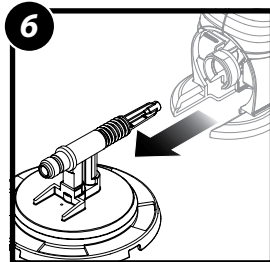
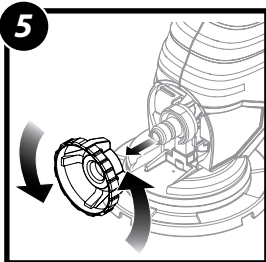
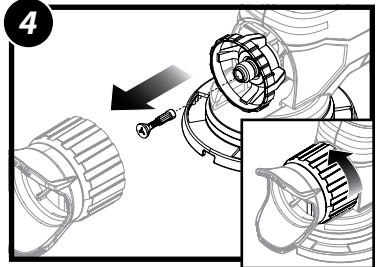
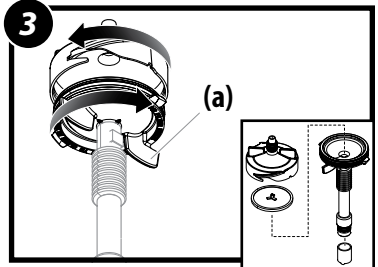
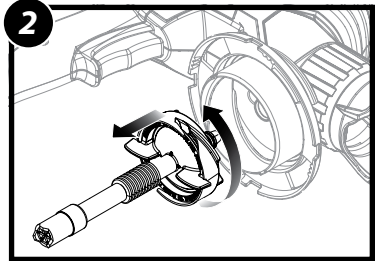
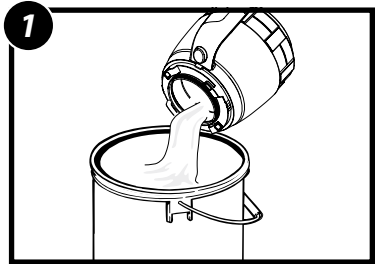

Cleanup (cup mode)

8. Clean all parts thoroughly with the brush provided using a solution appropriate to the type of material you sprayed.
9. **IMPORTANT:** Make sure to completely remove all material from the inside of the piston chamber by scrubbing with the brush. Even a small amount of material can dry like glue and keep the piston from moving, causing damage to the sprayer.
10. **IMPORTANT:** Make sure to keep the vent hole (a) on the pump housing clean and unblocked or a vacuum can build up in the container and cause damage to the sprayer. A toothpick or straightened paper clip can be used to clean it.
11. **Latex materials only** - Thread the cleaner nozzle onto a garden hose.
12. **Latex materials only** - Insert nozzle into the end of the suction tube and place into a waste container. Turn on the water and flush the suction tube until clean.
13. **Oil-based materials only** - Using the cleaning brush and mineral spirits, clean out the inside of the suction tube.
14. Lubricate the O-rings as shown with the included lubricant. Reassemble the filter assembly.

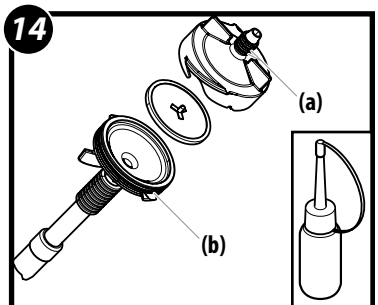
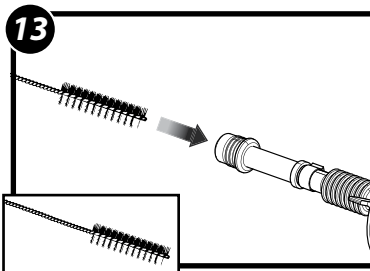
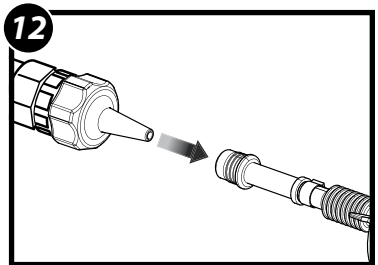
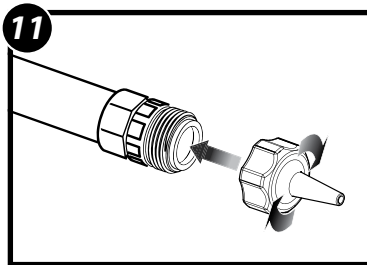
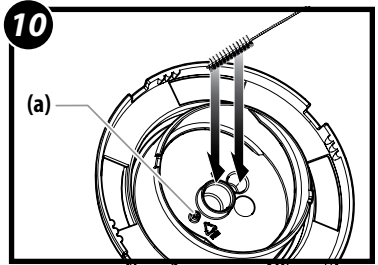
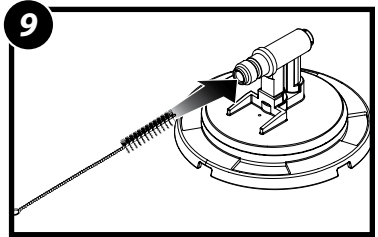
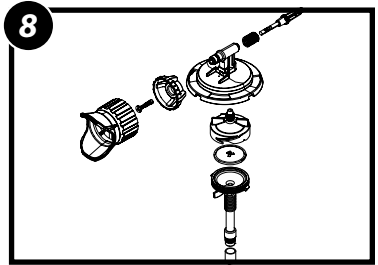

Cleanup (remote suction hoses / backpack kit)

You will need:

- Waste container
- Cleaner nozzle
- Warm soapy water if you sprayed latex materials
- Mineral spirits if you sprayed oil-based materials



Make sure you clean the sprayer in a well-ventilated area whenever cleaning with flammable solvents.



The sprayer contains electrical parts. DO NOT submerge the sprayer into any liquids.

Cleanup (remote suction hoses / backpack kit):

1. Unplug the sprayer.
Remove the remote suction set from the material container / backpack assembly and submerge into a container of the solvent appropriate to the type of material you sprayed.
2. Plug in the sprayer.
Squeeze the trigger and spray into a waste container until the cleaning solution comes through the sprayer for a couple of minutes.
3. Unplug the sprayer.
Remove the remote suction set housing from the sprayer. Remove smaller return hose from suction set housing.
4. Disassemble the remote suction set housing.
Clean all parts by hand using the cleaning brush and the appropriate cleaning solution. Reassemble.

Note: If you used the backpack kit, be sure to clean the suction tube and the inside of the backpack by hand using the appropriate cleaning solution.

5. **Latex materials only** - Thread the cleaner nozzle onto a garden hose.
6. **Latex materials only** - Insert nozzle into one of the remote suction hoses.
Place the other end of the hose into a waste container. Turn on the water and flush the hose until clean. Repeat for the other hose.
7. Reattach the smaller return hose to the dual hose fitting.
Follow steps 4-10 in **Cleanup - Cup Mode** (page 14).

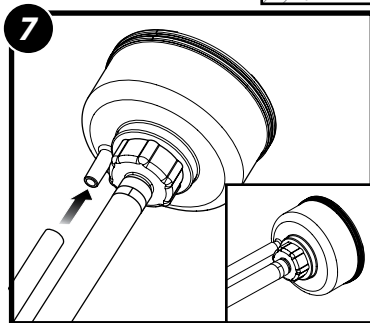
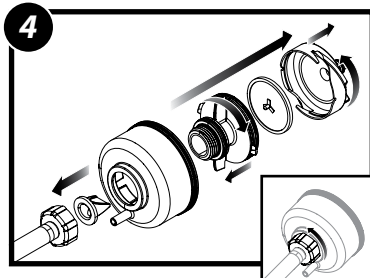
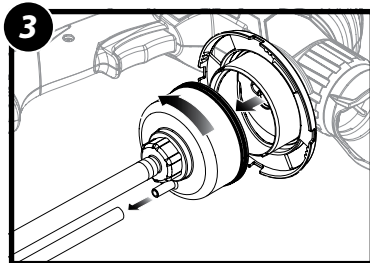
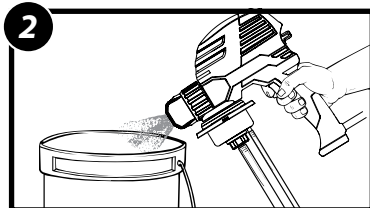
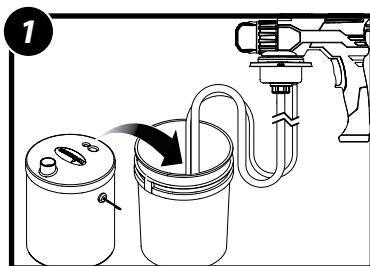
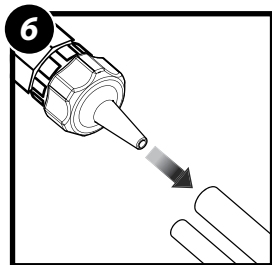
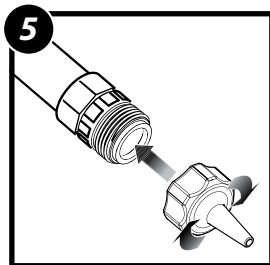

Reassembly / Maintenance

You will need:

- Scrap piece of wood or cardboard
- Lubricant

Note: Power Painter Max only - Refer to page 61 to see the proper way to repack the sprayer and components into the carrying case.

1. Slide the spring onto the front end of the piston. Insert the piston into the back of the pump housing.
2. Insert the pump housing assembly into the front of the sprayer.
3. Place the locking nut onto the pump housing. Press in while turning the locking nut clockwise.

Do not cross-thread the locking nut. Make certain it is threaded correctly before tightening.

4. Insert the atomizer valve into the front end of the pump housing. Place the adjustable spray tip assembly onto the pump housing and turn the tip nut clockwise until it is tightened securely.
5. Turn the sprayer upside-down while the cup is removed. Squeeze a small amount of lubricant into both the intake (a) and return (b) openings on the pump housing.
6. Plug in the sprayer. Aim at piece of scrap wood or cardboard and squeeze the trigger of the sprayer for 2 to 3 seconds while sprayer is still inverted.
7. Reassemble and reattach the filter and suction tube assembly.

Lubricate the O-ring (c) as shown with the included lubricant. Replace the cup.

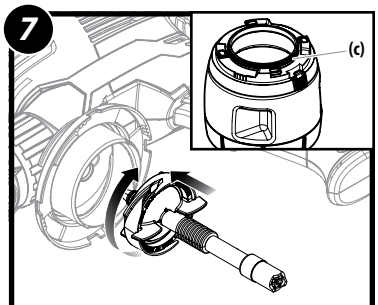
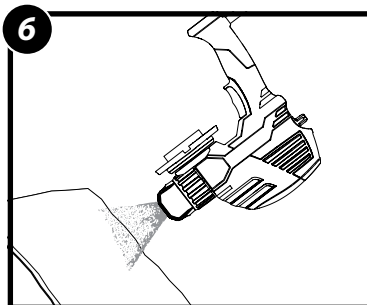
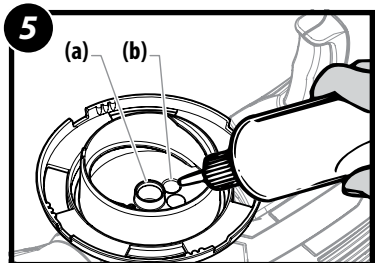
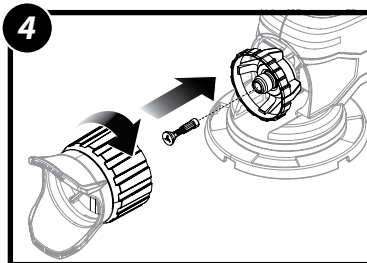
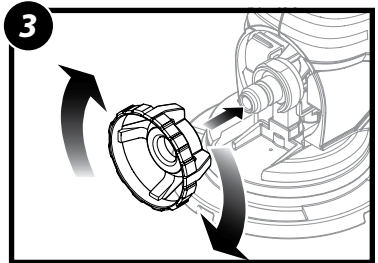
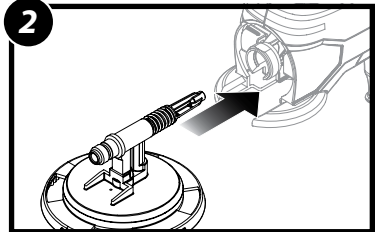
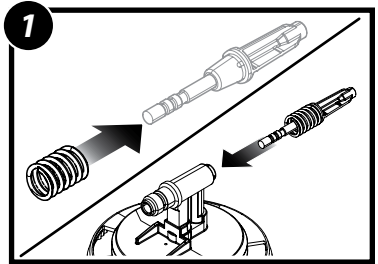

Troubleshooting



Any attempt to open the motor housing or repair any electrical parts within the unit by anyone other than an authorized repair technician could cause serious injury and will void the warranty.

PROBLEM	CAUSE	SOLUTION
Problem A: Motor will not run	<ol style="list-style-type: none"> 1. No power at wall outlet. Electrical problem or defective motor. 	<ol style="list-style-type: none"> 1. Try new wall outlet. Take to Authorized Service Center for repair.
Problem B: Motor has a low hum and does not spray	<ol style="list-style-type: none"> 1. Seized piston 	<ol style="list-style-type: none"> 1. Disassemble sprayer, clean and lubricate (follow Cleanup instructions)
Problem C: Motor operates properly but does not spray	<ol style="list-style-type: none"> 1. Failure to prime with remote suction set 2. Failure to prime with suction tube 3. Loose or damaged suction tube 4. Plugged or worn atomizer valve 5. Atomizer valve missing 6. Material selector needs adjusting 7. Speed setting too low 8. Plugged spray tip 9. Filter assembly plugged 10. Material too thick 11. Worn piston 	<ol style="list-style-type: none"> 1. Oil intake opening (see Reassembly / Maintenance section). Hold trigger for at least 3 minutes. Thin paint. Hold sprayer at even level with paint can. 2. Oil intake opening (see Reassembly / Maintenance section). Hold trigger for at least 20 seconds. Thin paint. 3. Tighten or replace 4. Clean or replace as needed 5. Replace atomizer valve 6. Adjust to "PAINT" setting. 7. Increase the speed setting (if equipped) 8. Clean tip 9. Clean filter assembly 10. Thin material 11. Clean and oil, or replace
Problem D: Material spitting or globbing (air has entered the system)	<ol style="list-style-type: none"> 1. Low on material 2. Worn atomizer valve 3. Plugged spray tip 4. Material selector needs adjusting 5. Speed setting too low 6. Worn piston 7. O-rings on filter assembly are dirty 8. Material too thick 	<ol style="list-style-type: none"> 1. Refill container 2. Replace atomizer valve 3. Clean the spray tip (follow Cleanup, Cup Mode instructions) 4. Adjust to "PAINT" setting. 5. Increase the speed setting (if equipped) 6. Clean and oil, or replace 7. Clean and lubricate (follow Cleanup, Cup Mode instructions) 8. Thin material

Troubleshooting

PROBLEM	CAUSE	SOLUTION
Problem E: Excessive fogging	<ol style="list-style-type: none"> 1. Material selector set too high 2. Holding sprayer too far from work surface 	<ol style="list-style-type: none"> 1. Set material selector to 'stain' 2. Hold sprayer closer to work surface
Problem F: Runs and sags in paint	<ol style="list-style-type: none"> 1. Arm movement too slow, holding spray gun too close or work surface, or applying too much paint at one time 	<ol style="list-style-type: none"> 1. See section on spraying (page 13)
Problem G: Material drips from spray tip or guard	<ol style="list-style-type: none"> 1. Guard is for safety and cannot be removed. Some dripping is unavoidable with some materials 	<ol style="list-style-type: none"> 1. Use a small brush on drips that fall on surface being sprayed. Use a drop cloth
Problem H: Material leaking from between spray tip and locking nut	<ol style="list-style-type: none"> 1. Spray tip is loose 2. Atomizer valve not positioned properly 3. Worn atomizer valve 4. Eroded pump housing 	<ol style="list-style-type: none"> 1. Tighten securely 2. Unplug the sprayer, remove the spray tip and reposition the atomizer valve 3. Replace 4. Replace the pump housing
Problem I: Motor overheats	<ol style="list-style-type: none"> 1. Seized piston 2. Extension cord too long 3. Operating continuously 	<ol style="list-style-type: none"> 1. Clean piston 2. Replace with proper size 3. Release trigger at the end of a pass, allow to cool.



This unit has no servicable electrical parts. Do not attempt to service this unit yourself.

Questions?

Call Wagner Technical Service at:

1-800-328-8251

Register your product online at:

www.wagnerspraytech.com

Replacement Parts

Notice:

Parts of your sprayer wear out with use and require regular replacement. They include the atomizer valve, piston and spring. These parts are not covered by your sprayer warranty.

More abrasive materials such as latex paints and stains cause these parts to wear out faster than less abrasive materials such as oil-based paints and stains, thin stains and sealers.

Atomizer valve:

The atomizer valve is shaped to cause the material to spin as it comes out of the sprayer. The spinning breaks the material up into a fine spray. As more material goes through the atomizer valve, it wears out the valve and the shape of the valve changes. When it changes too much to produce a good spray pattern, the valve needs to be replaced.

- 1 Front view of a good atomizer valve.
- 2 Front view of a atomizer valve after spraying 7-10 gallons of latex paint. Replace.
- 3 Front view of a atomizer valve after spraying 7-10 gallons of latex stain. Replace.

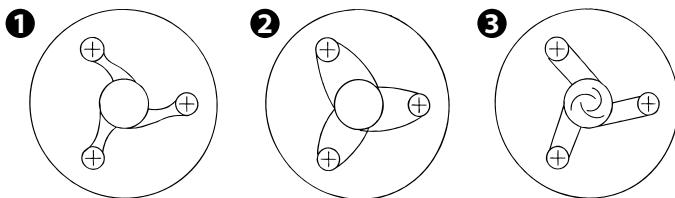

Piston and Spring:

The average life of a piston and spring will vary depending on the types of material being sprayed.

Replace the piston if the sprayer takes longer than 20 seconds with the suction tube to prime when well lubricated, or if there is an excess amount of material leaking, refer to the troubleshooting suggestions listed in this manual. Replace the spring if you notice that it is broken when you clean the sprayer.

To replace either the atomizer valve or the piston and spring, follow the Cleanup instructions on page 14-15, and replace the old parts with new ones. When replaced, follow Reassembly instructions, (page 17).

Power Painter Max only

Follow the diagram below in order to properly fit the sprayer and components into the carrying case.

Power Painter Max uniquement

Suivre le schéma ci-dessous afin de replacer correctement le pulvérisateur et ses pièces dans le boîtier de transport.

Solo dispositivo Power Painter Max

Siga el siguiente diagrama para ajustar adecuadamente el pulverizador y los componentes en el estuche.

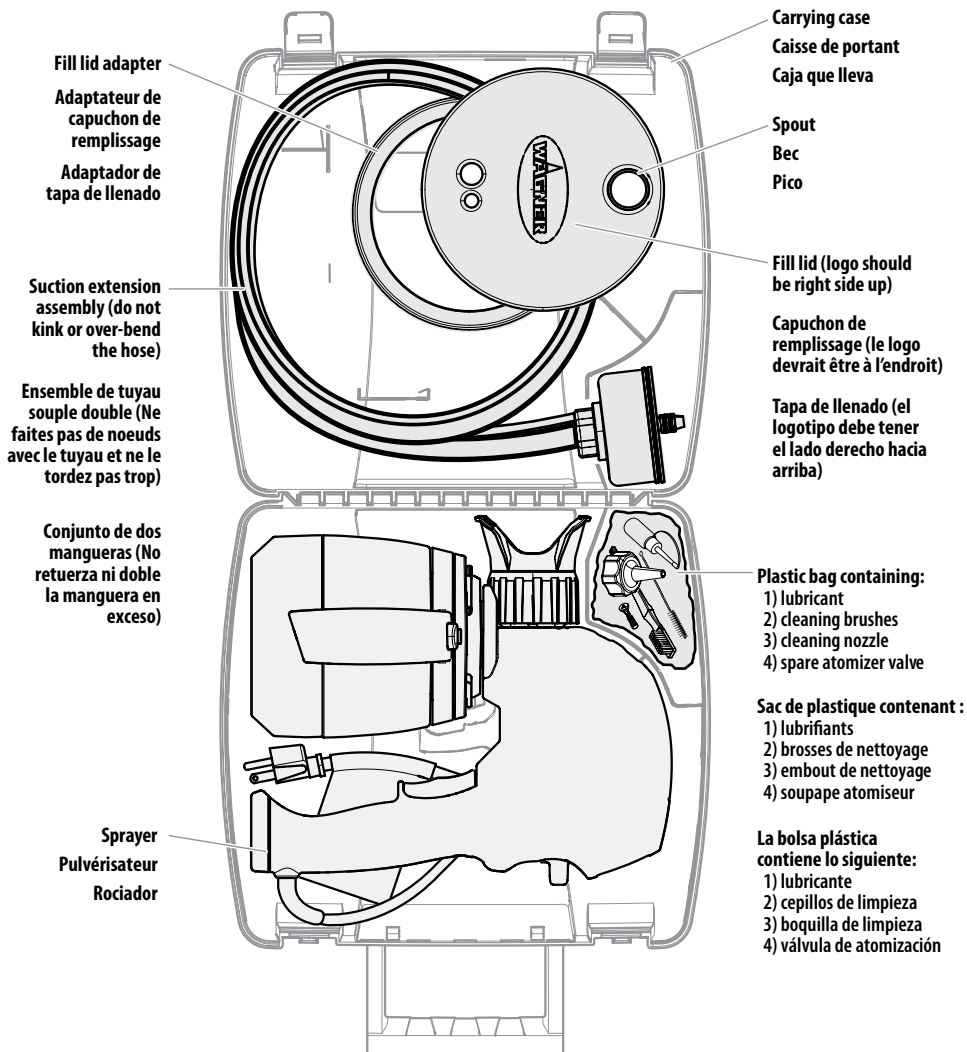

Parts List • Liste de pièces • Lista de piezas

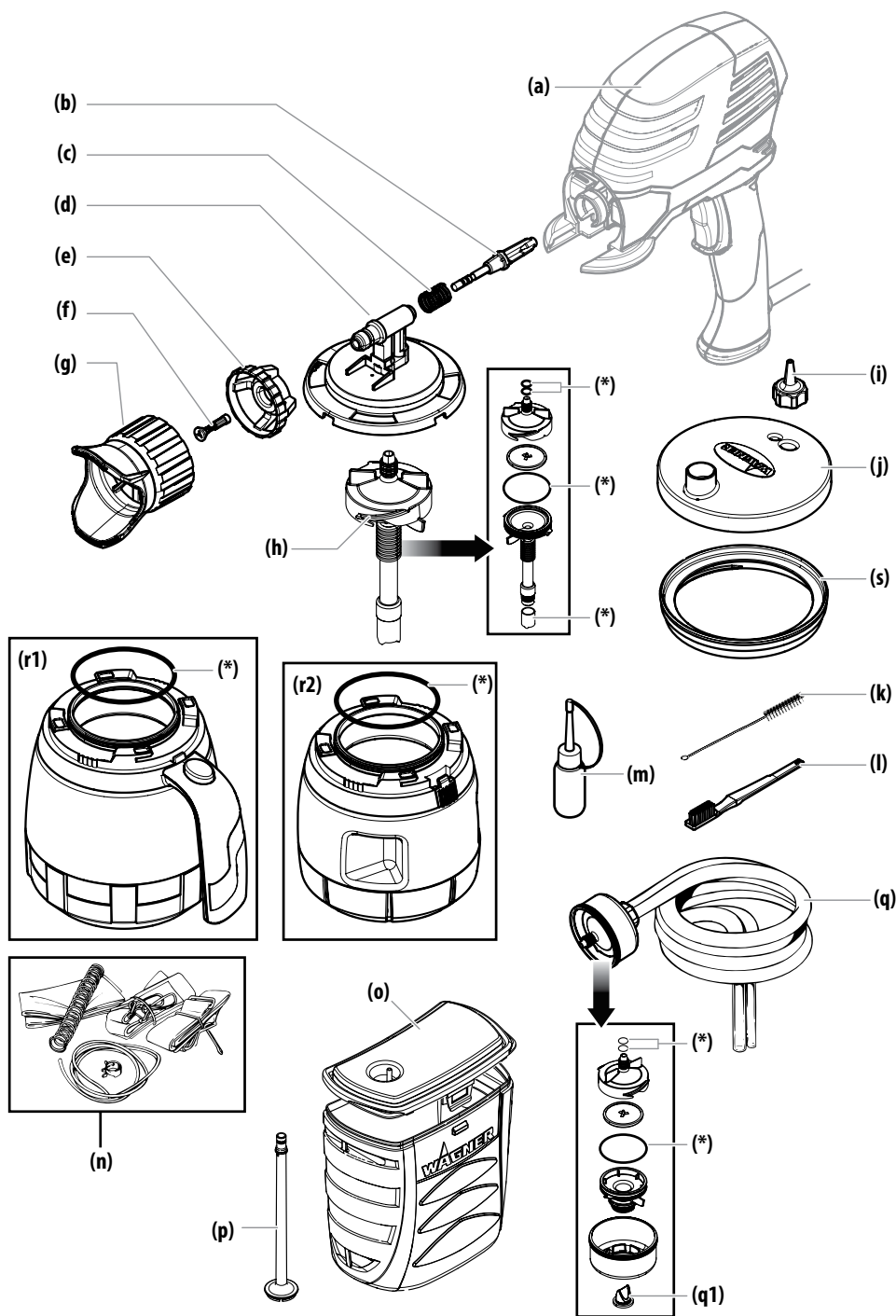

Parts List • Liste de pièces • Lista de piezas

Item Art. Ar.	Part No. N° de pièce Pieza No.	English Description	Français Description	Español Descripción	Qty. Qte. Cant.
a)	-----	Sprayer assembly	Pulvérisateur	Rociador	1
b)	0199903	Piston	Piston	émbolo	1
c)	0016101	Spring	Ressort	Resorte	1
d)	0525261	Pump housing	Corps de pompe	Caja de la bomba	1
e)	0525540	Lock nut	Bague de blocage	Tuerca del émbolo	1
f)	0525118	Atomizer valve	Soupape atomiseur	Válvula de atomización	2
g)	0525145	Spray tip	Buse à pulvériser	Punta de rociadora	1
h)	0525146A	Suction tube with filter (Power Painter/Stainer Plus)	Tube d'aspiration avec filtre (Power Painter/Stainer Plus)	Tubo de succión con filtro (Power Painter/Stainer Plus)	1
	0525147A	Suction tube with filter (Power Painter Max/Pro)	Tube d'aspiration avec filtre (Power Painter Max/Pro)	Tubo de succión con filtro (Power Painter Max/Pro)	1
i)	0525594	Cleaner nozzle	Embout de nettoyage	Boquilla de limpieza	1
j)	0525677	Fill lid	Capuchon de remplissage	Tapa de llenado	1
k)	0514209	Cleaning brush	Brosse de nettoyage	Cepillo de limpieza	1
l)	0525689	Cleaning brush	Brosse de nettoyage	Cepillo de limpieza	1
m)	0516913	Lubricant	Lubrifiants	Lubricante	1
(*)	0525148	O-ring and valve kit (includes all items labeled with (*). Available by calling customer service)	Ensemble du joint torique et de la soupape (comprend tous les articles marqués d'un *). Disponible en communiquant avec le service à la clientèle)	Juntas y juego de válvula (incluye todos los elementos marcados con un [*]). Disponibles mediante contacto telefónico con nuestro Servicio al Cliente)	
Power Painter Pro only • Power Painter Pro seulement • Power Painter Pro solamente					
n)	0518225	Strap kit	Ensemble de courroies	Juego de correas	1
o)	0525135	Backpack assembly	Ensemble de sac à dos	Ensamblaje de mochila	1
p)	0525376	Backpack suction tube	Tube d'aspiration (sac à dos)	Tubo de succión para mochila	1
Power Painter Max / Power Painter Pro only • Power Painter Max / Power Painter Pro seulement • Power Painter Max / Power Painter Pro solamente					
q)	0525195	Suction extension assembly	Ensemble de tuyau souple double	Conjunto de dos mangueras	1
q1)	0271434	Valve	Soupape	Válvula	1
r1)	0525285	Material container (1 1/2 qt)	Réservoir de matériel (1,5 l)	Contenedor de material (1,5 l)	1
s)	0525628	Fill lid adapter	Adaptateur de capuchon de remplissage	Adaptador de tapa de llenado	1
Power Painter / Stainer Plus only • Power Painter / Stainer Plus seulement • Power Painter / Stainer Plus solamente					
r2)	0525264	Material container (1 qt)	Réservoir de matériel (1 l)	Contenedor de material (1 l)	1
Power Painter Max only • Power Painter Max seulement • Power Painter Max solamente					
	0525297	Carrying case (not pictured)	Caisse de portant (non décrite)	Caja que lleva (no representada)	1

WAGNER ONE-YEAR LIMITED WARRANTY - Keep on File

This product, manufactured by Wagner Spray-Tech Corporation (Wagner) is warranted against defects in material and workmanship for one year following date of purchase if operated in accordance with Wagner's printed recommendations and instructions. This warranty does not cover damage resulting from improper use, accidents, user's negligence or normal wear. This warranty does not cover any defects or damages caused by service or repair performed by anyone other than a Wagner Authorized Service Center.

ANY IMPLIED WARRANTY OF MERCHANTABILITY OR FITNESS FOR A PARTICULAR PURPOSE IS LIMITED TO ONE YEAR FOLLOWING DATE OF PURCHASE. THIS PRODUCT IS DESIGNED FOR HOME USAGE ONLY. IF USED FOR COMMERCIAL OR RENTAL PURPOSES, THIS WARRANTY APPLIES ONLY FOR 30 DAYS FROM DATE OF PURCHASE. WAGNER SHALL NOT IN ANY EVENT BE LIABLE FOR ANY INCIDENTAL OR CONSEQUENTIAL DAMAGES OF ANY KIND, WHETHER FOR BREACH OF THIS WARRANTY OR ANY OTHER REASON. THIS WARRANTY DOES NOT APPLY TO ACCESSORIES.

If any product is defective in material and/or workmanship during the applicable warranty period, return it with proof of purchase, transportation prepaid, to any Wagner Authorized Service Center. (A listing of Service Center locations is enclosed with this product.) Wagner's Authorized Service Center will either repair or replace the product (at Wagner's option) and return it to you, postage prepaid.

Spray Tip Lifetime Warranty

The spray tip you have purchased with your Wagner Power Painter is warranted against wear for the life of the Power Painter. The spray tip warranty does not cover damage resulting from improper use, accidents or user's negligence.

If the spray tip fails due to wear, return it, postage prepaid, to Wagner Spray Tech Corporation, Spray Tip Replacement, 1770 Fernbrook Lane, Plymouth, MN 55447. Please include your name, complete address and telephone number with the spray tip. Allow 6 to 8 weeks for delivery.

SOME STATES DO NOT ALLOW LIMITATIONS ON HOW LONG AN IMPLIED WARRANTY LASTS OR THE EXCLUSION OF INCIDENTAL OR CONSEQUENTIAL DAMAGES, SO THE ABOVE LIMITATION AND EXCLUSION MAY NOT APPLY TO YOU. THIS WARRANTY GIVES YOU SPECIFIC LEGAL RIGHTS, AND YOU MAY ALSO HAVE OTHER RIGHTS WHICH VARY FROM STATE TO STATE.

GARANTIE LIMITÉE D'UN AN - À conserver

Ce produit, fabriqué par Wagner Spray Tech Corporation (Wagner), est garanti contre les défauts de matériaux et de fabrication pendant un an suivant la date d'achat, s'il est utilisé conformément aux recommandations et directives imprimées par Wagner. Cette garantie ne couvre pas les dégâts qui résultent d'une mauvaise utilisation, les accidents, la négligence de l'utilisateur ou l'usure normale. Cette garantie ne couvre aucun dégât dû des opérations de maintenance effectuées par tout autre qu'un réparateur approuvé par Wagner.

TOUTE GARANTIE IMPLICITE DE QUALITÉ MARCHANDE OU DE CONFORMITÉ A UN USAGE PARTICULIER EST LIMITÉE A UN AN A PARTIR DE LA DATE D'ACHAT. CE PRODUIT N'EST CONÇU QUE POUR UNE UTILISATION PRIVÉE. DANS LE CAS DE LOCATION OU AUTRES APPLICATIONS PROFESSIONNELLES, CETTE GARANTIE SE LIMITE A 30 JOURS A PARTIR DE LA DATE D'ACHAT. WAGNER NE POURRA EN AUCUN CAS ETRE TENUE RESPONSABLE DE DOMMAGES-INTERETS INDIRECTS OU CONSÉQUENTS, QUE CE SOIT POUR UNE RUPTURE DE CETTE GARANTIE OU TOUTE AUTRE RAISON. CETTE GARANTIE NE S'APPLIQUE PAS AUX ACCESSOIRES.

Si un produit est défectueux, au niveau des matériaux ou de la fabrication, au cours de la durée applicable de la garantie, le renvoyer avec une preuve d'achat, port payé, à l'un des centres de service autorisé par Wagner. (Une liste des adresses de ces centres accompagne tous les produits). Le centre de service autorisé réparera ou remplacera le produit (au choix de Wagner) et le renverra, port payé, à l'utilisateur.

Garantie à vie de la buse du pulvérisateur

Le buse livrée avec ce produit Wagner est garanti contre l'usure pour toute la durée utile de l'appareil. Cette garantie ne couvre pas les dégâts résultant d'une mauvaise utilisation du produit, d'accidents ou d'une négligence de l'utilisateur.

Si le buse du pulvérisateur s'use, le renvoyer, port payé, à Wagner Spray Tech Corporation, Spray Tip Replacement, 1770 Fernbrook Lane Plymouth, Minnesota 55447 (USA). Prière de joindre le nom, l'adresse et le numéro de téléphone de l'utilisateur. Compter un délai de livraison de 6 à 8 semaines.

CERTAINS ETATS OU PROVINCES NE PERMETTENT PAS LA LIMITATION DE LA DURÉE DE LA GARANTIE IMPLICITE OU L'EXCLUSION DES DOMMAGES-INTERETS INDIRECTS OU ACCESSOIRES. LES RESTRICTIONS APPARAISSANT AUX PRÉSENTES POURRAIENT DONC NE PAS S'APPLIQUER A L'UTILISATEUR. LA PRÉSENTE GARANTIE CONTIÈRE DES DROITS PRÉCIS A L'UTILISATEUR, MAIS CELUI-CI POURRAIT AVOIR D'AUTRES DROITS EN VERTU DES LÉGISLATIONS LOCALES.

GARANTIA LIMITADA POR UN AÑO - Manténgala archivada

Este producto, fabricado por Wagner Spray Tech Corporation (Wagner), está garantizado contra defectos de materiales y de mano de obra por un año a partir de la fecha de compra, si se utiliza de acuerdo con las instrucciones y recomendaciones especificadas por Wagner. Esta garantía no cubre daños producidos por uso indebido, accidentes, negligencia del usuario o desgaste normal del producto. Tampoco cubre defectos o daños producidos por reparaciones o mantenimiento no realizados por un Centro de servicio autorizado de Wagner.

CUALQUIER GARANTIA IMPLICITA DE COMERCIALIZACION O DE BUEN ESTADO PARA PROPOSITOS ESPECIFICOS ESTA LIMITADA POR UN AÑO A PARTIR DE LA FECHA DE COMPRA. ESTE PRODUCTO SOLO HA SIDO DISEÑADO PARA USO DOMESTICO. SI SE LE DA USO PROFESIONAL, Y DE RENTA, ESTA GARANTIA TIENE UNA DURACION DE 30 DIAS A PARTIR DE LA FECHA DE COMPRA. BAJO NINGUNA CIRCUNSTANCIA WAGNER SE RESPONSABILIZARA POR CUALQUIER DAMO ACCIDENTAL O COMO CONSECUENCIA DEL USO DEL PRODUCTO. YA SEA POR LA VIOLACION DE ESTA GARANTIA O POR CUALQUIER OTRA RAZON. ESTA GARANTIA NO INCLUIE LOS ACCESORIOS.

Si cualquier producto presentara defectos de materiales y/o de mano de obra durante el periodo válido, devuélvala con el recibo de compra y el flete pagado a cualquier Centro de servicio autorizado de Wagner (este producto viene con una lista de los Centros de servicio). El Centro de servicio autorizado de Wagner reparará o reemplazará el producto (de acuerdo a su criterio) y se lo devolverá haciendo uso de los gastos de flete ya pagados.

Garantía vitalicia de la punta rociadora

La punta rociadora que usted ha adquirido con su equipo rociador de pintura Wagner está garantizada contra desgaste por el tiempo que dure su rociador. La garantía de la punta no cubre daños producidos por uso indebido, accidentes o negligencia del usuario.

Si la punta falla, debido a desgaste, devuélvala con franqueto pagado a Wagner Spray Tech Corporation, Spray Tip Replacement, 1770 Fernbrook Lane, Plymouth, Minnesota 55447. Por favor, junto con la punta, incluya su nombre, su dirección completa y su número de teléfono. La punta se le devolverá en de 6 a 8 semanas.

ALGUNOS ESTADOS NO PERMITEN LIMITACIONES DE TIEMPO A LAS GARANTIAS IMPLICITAS NI TAMPOCO LA EXCLUSION DE DAÑOS ACCIDENTALES O COMO CONSECUENCIA DEL USO DEL PRODUCTO. POR LO QUE ES POSIBLE QUE LA LIMITACION ANTERIOR NO SE APLIQUE A SU CASO PARTICULAR. ESTA GARANTIA LE OTORGA CIERTOS DERECHOS LEGALES ESPECIFICOS Y TAMBIEN PUEDE ACCEDER A OTROS DERECHOS QUE VARIAN DE UN ESTADO A OTRO.