

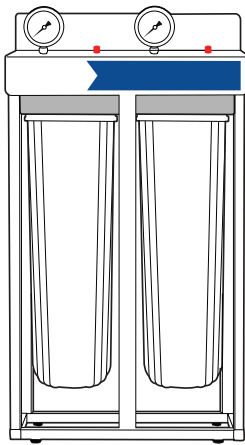

Whole House System Filter Change

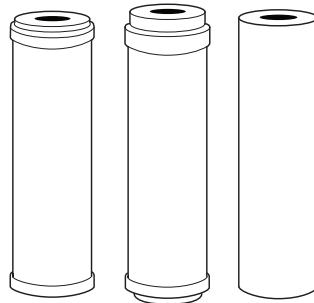

2 Stage Whole House



Replacement Filters

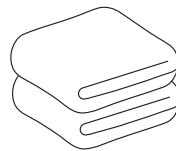

Towels

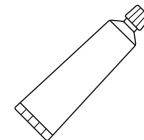

Silicone
Lubricant

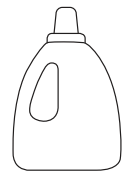

Bleach

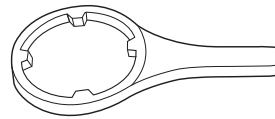

Filter Housing Wrench

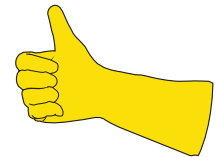

Cleaning Gloves

Filter Change Instructions

Each filter is good for approximately 6 months or up to 100,000 gallons of water. The amount of time and water depends on the quality, temperature, and pressure of your water supply. Your replacement cycle may be longer or shorter because of this.

If you notice a drop in your water pressure in your home or on the pressure gauges, this usually indicates you are ready for a filter replacement. Once your pressure has dropped 10-20 PSI from your initial pressure we suggest replacing your filters.

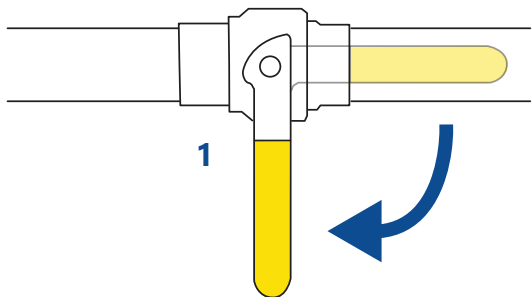

1. Turn Off Water Supply

First, turn off water supply to the system. Open the nearest faucet until flow stops to depressurize your plumbing. Shut off the faucet once flow has stopped.

2. Press the red pressure button

Prepare for water discharge from system then press the red pressure release button.

Use your Filter Housing Wrench to unscrew the housings from your system.

Remove the old filter and throw it away. Drain any remaining water from the housing.

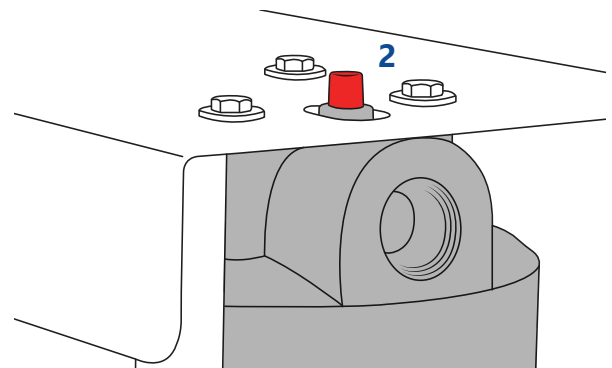

3. Filter Cleaning

We recommend cleaning your filter housing once a year. To do this scrub the inside of the housing and the inside of the top manifold with one gallon of warm water mixed with 1 tablespoon of household bleach. Make sure to protect your hands during cleaning. Rinse all parts with water until all traces of bleach are gone.

Note! Do not add bleach directly to any part of the system



4. Reattaching Housing

Your o-ring may come loose during the housing removal. If it doesn't carefully remove it from the housing and apply your silicone lubricant to the o-ring, before setting it back in place.

Apply lubricant to the threads of the filter housing.



5. Align New Filter

Insert the new filter facing the correct direction. The carbon, KDF, or PHO filters will need to have their o-ring facing the top of the system.

Make sure your filter is correctly aligned. Support the base of the housing and insert it back into the top manifold. Then tighten the housing by hand.

Once the housing is hand tight, use your filter housing wrench to give a slight additional turn. You should only need a fourth turn or a half turn with the wrench, be careful not to over-tighten.

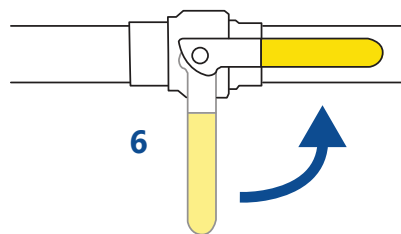
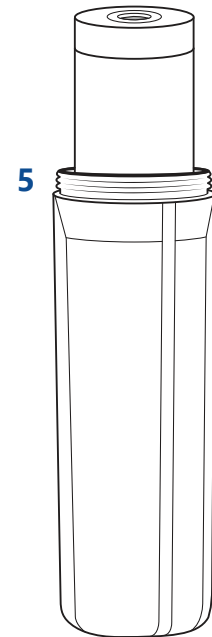

6. System Start-up

Once your filter has been replaced and your housing is in place you are ready to turn on water supply to the system.

Check for leaks as the system fills with water.

If you discover a leak turn the water off, inspect your connection points and o-rings, retighten and try again.

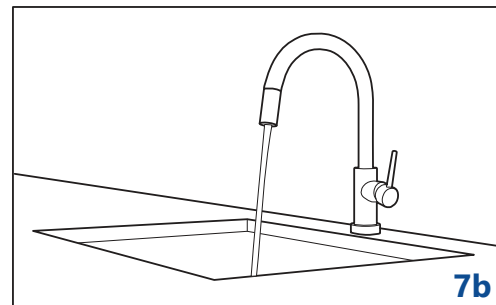
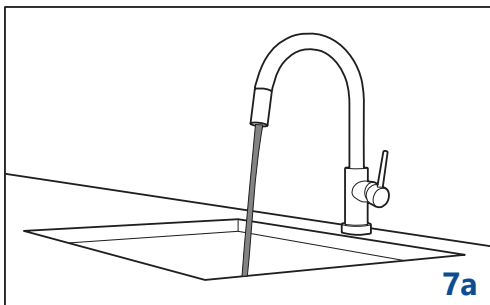

7. Readyng New Filters

Flush your new filters by turning on cold water from the closest faucet.

The water will become blackish as loose carbon particles are flushed out of the system. The water may also appear cloudy as air bubbles are pushed out of the system and your pipes. This is perfectly normal. Run the water until it becomes clear, then run for 5 additional minutes before turning the faucet off.

Wait 30 minutes, then run the cold water again for 10 minutes. **Your system is now ready to use!**