

Item ID	Front Thickness [in] mm	Door Thickness [in] mm
EH2135B-GB	[.75] 19	[.75] 19

This profile belongs to EH2135B-GB

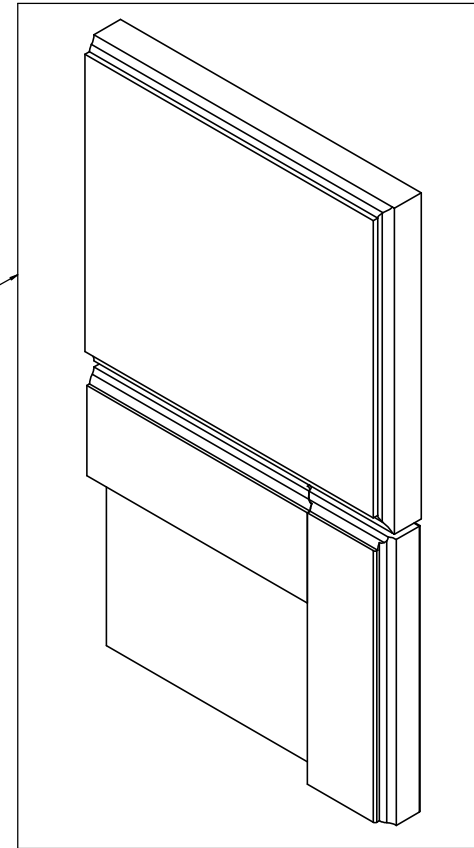
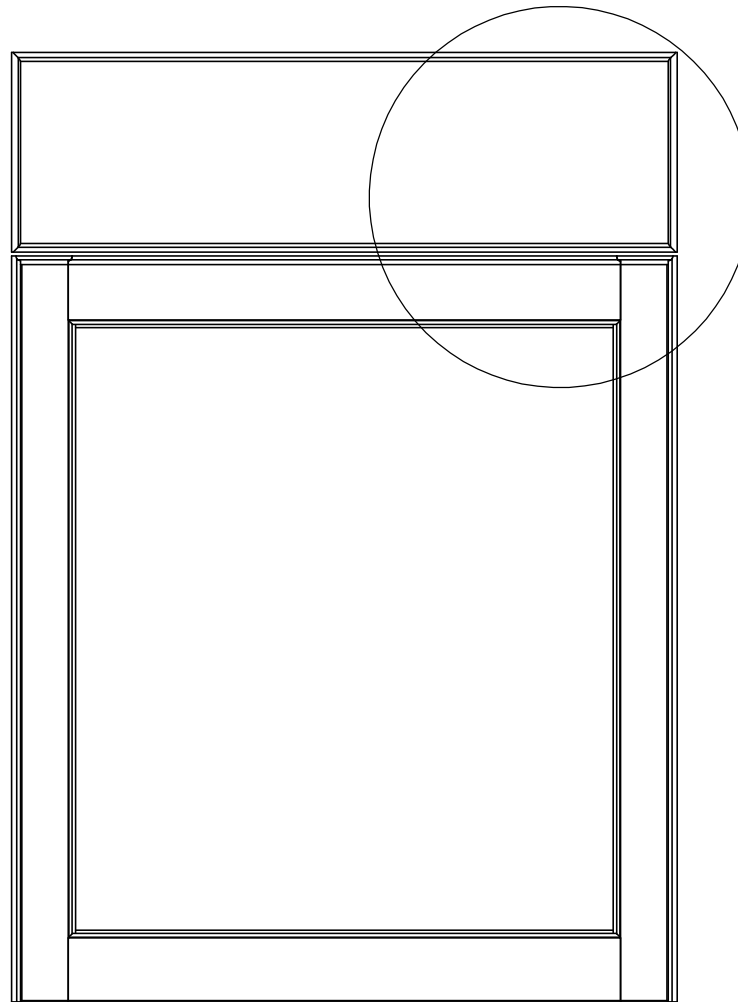

Detailed View

Profile: Easthaven German Beech

PROPRIETARY AND CONFIDENTIAL
 THE INFORMATION CONTAINED IN THIS DRAWING IS THE SOLE PROPERTY OF WOODCRAFTERS. ANY REPRODUCTION IN PART OR AS A WHOLE WITHOUT THE WRITTEN PERMISSION OF WOODCRAFTERS IS PROHIBITED.

UNLESS OTHERWISE SPECIFIED
 DIMENSIONS ARE IN MM AND [INCHES]
 TOLERANCES ARE
 +.039[1]-.039[1]
 SCALE:1:2



Item ID	Shelf Thickness mm (in)	Depth "X"
BT3636W-BT	19 (.75)	12.6
BT3636W-WH	19 (.75)	12.5
BT3636W-RC	19 (.75)	12.6
CM3636W-DK	19 (.75)	12.6
EH3636W-GB	19 (.75)	12.6
CM3636W-KG	19 (.75)	12.5

REV	ECO#	DESCRIPTION	REV'D BY DATE	CHK'D BY DATE	APRV'D BY DATE
0		New Release	ASG 8/23/17	ASG 8/23/17	ASG 8/23/17
1		Removed back cleats and MDF backing and replaced them with a full back of PB 1/2in	ASG 7/25/18	ASG 7/25/18	ASG 7/25/18

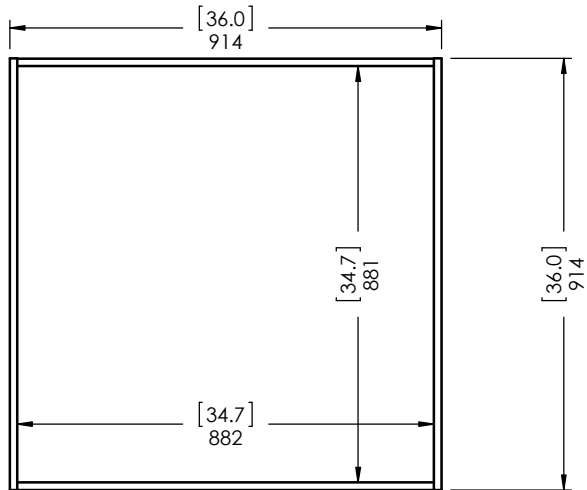

BACK VIEW

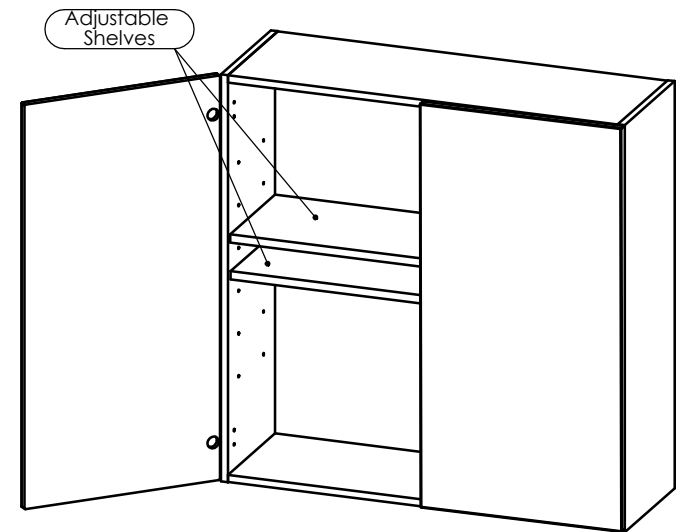
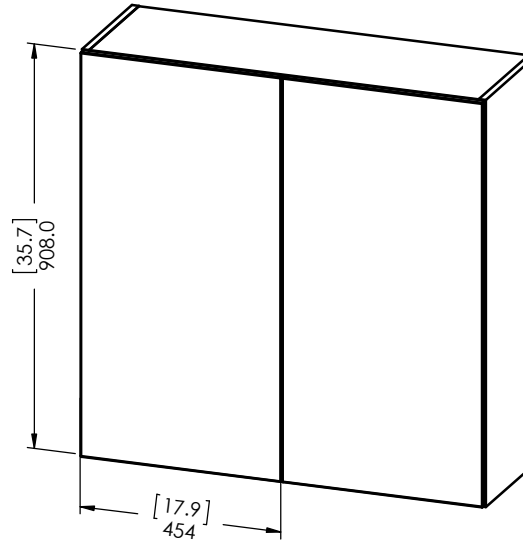

ISOMETRIC VIEW

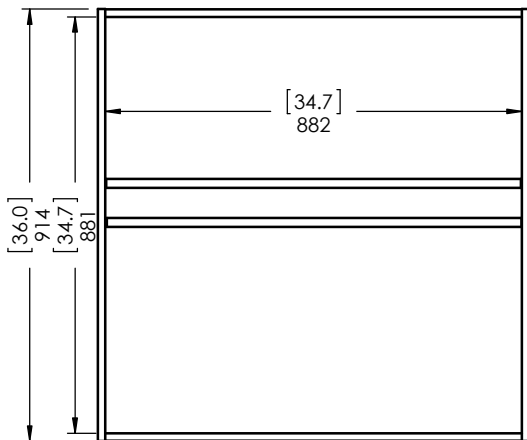

**Front View
(front door
removed)**

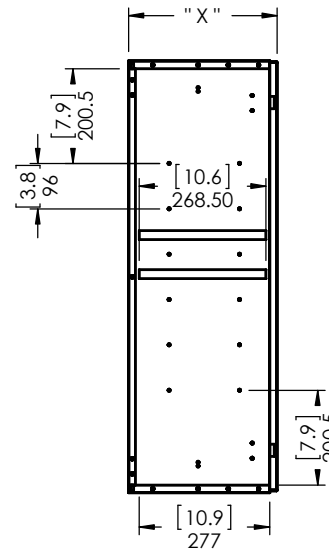

**Side View
(left panel
removed)**

PROPRIETARY AND CONFIDENTIAL
THE INFORMATION CONTAINED IN THIS DRAWING IS THE SOLE PROPERTY OF WOODCRAFTERS HOME PRODUCTS L.L.C. ANY REPRODUCTION IN PART OR AS A WHOLE WITHOUT THE WRITTEN PERMISSION OF WOODCRAFTERS HOME PRODUCTS L.L.C. IS PROHIBITED.

UNLESS OTHERWISE SPECIFIED
DIMENSIONS ARE IN mm
and [inches]
AND TOLERANCES ARE
+/- 0.5(0.02)

DRAWN BY:	A.Salinas	8/23/17
CHECKED BY:	A.Salinas	8/23/17
APPROVED BY:	A.Salinas	8/23/17
DO NOT SCALE DRAWING	SCALE: 1:20	SIZE: A

Wood Crafters
PART NO.: **Kitchen Wall Cabinet 36x36** SHEET 1 OF 1 REV: 1