



FORWARD PLATE COMPACTOR 79CC 2000LBS

ITEM: 61014



OWNER'S MANUAL AND SAFETY INSTRUCTIONS

SAVE THIS MANUAL: KEEP THIS MANUAL FOR SAFETY WARNINGS, PRECAUTIONS, ASSEMBLY, OPERATING, INSPECTION, MAINTENANCE AND CLEANING PROCEDURES. WRITE THE PRODUCT'S SERIAL NUMBER ON THE BACK OF THE MANUAL NEAR THE ASSEMBLY DIAGRAM (OR MONTH AND YEAR OF PURCHASE IF PRODUCT HAS NO NUMBER)

FOR QUESTIONS PLEASE CALL OUR CUSTOMER SUPPORT: (909) 628 4900 MON-FRI 9AM TO 3PM PST



GENERAL SAFETY WARNINGS

Read all safety warnings and instructions. Failure to follow the warnings and instructions may result in electric shock, fire and/or serious injury. Save all warnings and instructions for future reference.

SAFETY

WARNING DO NOT use this product or any available optional equipment without first completely reading and understanding these instructions and any additional instructional material such as owner's manuals, service manuals or instruction sheets supplied with this product or optional equipment. When using an electrical appliance, basic precautions **MUST** be followed to reduce the risk of fire, electric shock and personal injury.

- **DANGER: CARBON MONOXIDE** Using a plate compactor indoors **CAN KILL YOU IN MINUTES**. Engine exhaust contains carbon monoxide (CO). This is a poison gas you cannot see or smell. If you can smell the engine exhaust, you are breathing CO. Even if you cannot smell the exhaust, you could be breathing CO.
- **NEVER** use a plate compactor inside homes, garages, crawl spaces, or other partially/fully enclosed areas. Deadly levels of carbon monoxide can build up in these areas. Using a fan or opening windows and doors does **NOT** supply enough fresh air. **ONLY** use outside and far away from windows, doors, and vents. These openings can pull in engine exhaust.
- **WARNING:** The exhaust from this product contains chemicals known to the State of California to cause cancer, birth defects, or other reproductive harm.
- **WARNING:** This engine may emit highly flammable and explosive gasoline vapors, which can cause severe burns or even death if ignited. A nearby open flame can lead to explosion even if it isn't directly in contact with gasoline.
- **DO NOT** operate near an open flame.
- **DO NOT** smoke near the plate compactor.
- **ALWAYS** turn the plate compactor off before refuelling, allow it to cool for at least 2 minutes before removing the fuel cap. Loosen the cap slowly to relieve pressure in the tank.
- **DO NOT** overfill the tank. Gasoline may need to expand during operation. **DO NOT** fill to the top of the tank, allow for expansion.
- **ALWAYS** wipe up spilled fuel before operating.
- Empty the fuel tank before storing or transporting the plate compactor.
- **DO NOT** use the plate compactor in wet conditions.
- **DO NOT** allow children or non-qualified persons to operate the plate compactor.
- **DO NOT** touch hot surfaces. Pay attention to warning labels on the machine identifying hot parts.
- Allow the unit to cool down after use before touching the engine or areas of the plate compactor that become hot during use.
- Only use the compactor for intended purposes.
- **KEEP** hands and feet clear of rotating and moving parts as they will cause injury if contacted.

- Operate the plate compactor on flat, level surfaces only.
- Turn the engine OFF when the compactor is not in use.
- **DO NOT** operate or service this machine before reading this entire manual.
- Never operate this equipment without proper protective clothing, shatter proof ANSI-approved glasses, steel-toed boots, and other protective job site devices.
- **NEVER** operate the equipment while under the influence of medication, drugs or alcohol.
- **ALWAYS** check the machine for loosened bolts and threads **BEFORE** every use.
- **ALWAYS** wear proper respiratory, hearing and eye protection during operation.
- The Manufacturer does not assume responsibility for any accident due to equipment modifications and will also void the warranty.
- **NEVER** use accessories or attachments that are not recommended by STARK for this model of plate compactor.
- **DO NOT** add fuel to the plate compactor if it placed on top of a plastic surface such as a pickup truck bed with a plastic liner. This creates the possibility of ignition or explosion due to static electricity build up.
- **ALWAYS** refuel in a well ventilated area. **NEVER** operate near open flames, sparks or other item that could cause the gas fumes to ignite.
- Before performing compacting work near buildings or above pipelines, check the effect of the vibrations on the buildings and pipelines. If necessary, immediately stop the compacting work.
- **WARNING:** This unit produces heat when running. Temperatures near exhaust can exceed 150 F (65 C).
- **NOTE:** We suggest running the plate compactor engine at least once a month in order to maximize the lifespan of the machine.
- Plate compactors are heavy units and should be positioned by two people of appropriate strength. Using the lifting handles provided on the machine, along with correct lifting techniques.
- **DO NOT** operate the machine unless all protective guards are in place.
- **ENSURE** that the walls of a trench are stable and will not collapse due to the action of the vibration, prior to commencing compaction.
- **ENSURE** that the area to be compacted does not contain any “live” electrical cables, gas, water or communication services which may be damaged by the action of the vibration.
- **EXERCISE CARE** when operating unit. Exposure to vibration or repetitive work actions may be harmful to hands and arms.
- **DO NOT** increase the governed no-load motor speed above 3,500 r/min. Any increase may result in personal injury and damage to the machine. **BE CAREFUL** not to come in contact with the muffler when the engine is hot, since it can cause severe burns.
- **FIRE & EXPLOSION HAZARDS: PETROL** is extremely flammable and explosive under certain conditions. **ENSURE** that petrol is only stored in an approved storage container. **DO NOT** refuel the motor while it is in operation or hot.

OPERATION

The machine is best suited to the compaction of bituminous and granular materials e.g. granular soils, gravels and sands or mixtures of both. Cohesive soils such as silt and clay are best compacted using the impact force produced by a vibrating rammer. Where possible the site should be graded and levelled before commencing compaction.

Correct moisture content in soil is vital to proper compaction. Water acts as a lubricant to help slide soil particles together. Too little moisture means inadequate compaction and too much moisture leaves water-filled voids that weaken the soil's load bearing ability.

Use unleaded grade petrol and ensure that the fuel is free from contamination.

The vibratory motion provides a self propelling action. Position the handle at the opposite end of the machine to the vibrator.

Start the motor using the recoil starter (If the motor is fitted with an on/off switch this must first be turned to ON before starting.)

For more information on starting and correct operating procedures of the motor, refer to the motor operation manual supplied with the unit.

Increase the motor speed to the maximum setting using the hand throttle lever, before compacting.

The machine should be controlled by grasping the handle with both hands and applying restraint to control the forward motion. Steer the machine by moving the handle sideways to the right or left.

ALWAYS maintain good footing so that you do not slip and loose control when starting or operating the machine.

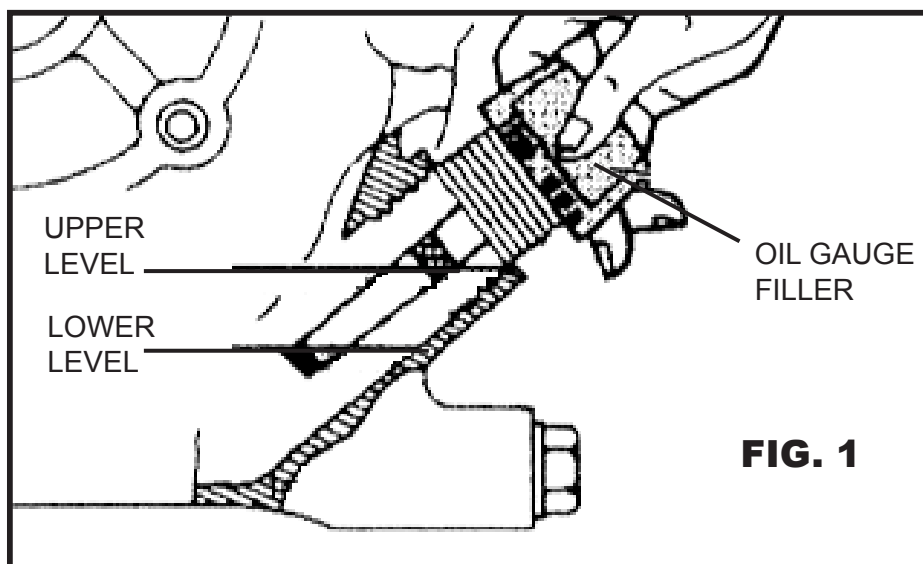

SEASON TEMP.	MOTOR OIL GRADE
Spring Summer or Autumn +120°F to +40°F	SAE 30
Winter +40°F to +15°F	SAE 20
Below+15°F	SAE 10W-30

OPERATION

PRIOR TO OPERATION

- Make sure that all dirt, mud, etc., are thoroughly removed from the unit prior to operation. Special effort should be given to the button face of the vibrating plate and those areas adjacent to the cooling air inlet of engine, carburetor, and air cleaner.
- Check all bolts and screws for tightness and make sure all bolts and screws are securely tightened. Loose bolts and screws may cause damage to the unit.
- Check the V-belt for tightness. The normal slack should be approximately 10-15mm(1/2")when the belts are forcibly depressed in the middle position between the two sheaves. If there is excess belt play, there could be a decrease in the impact force or erratic vibration, causing machine damage.
- Check the engine oil level and if the engine oil level is low, it should be refilled. Use the proper motor oil as suggested in the table on page 3. See Fig. 1
- Remove the oil plug in the vibrator assembly and check the oil level. Make sure the compactor is level when checking. The oil level should be up to the oil plug. Every month or every 200 hours of operation, replace the oil.
- **IMPORTANT:** Use the motor oil SAE When changing the oil, the old oil can be drained by tipping the unit. The oil will drain easily while it is hot.
- A regular grade gasoline should be used in the engine. When filling the fuel tank, make sure the fuel filter is used.
- **CAUTION:** Be careful with the operating place and ventilation. Avoid operating the machine in a closed room, tunnel, or other badly ventilated places since its exhaust contains deadly poisonous carbon monoxide. If the machine is employed unavoidable operated in such a place, discharge the exhaust out side the room by a suitable mean.
- Observe with the following cautions when transporting: Clamp fuel tank cap securely and turn the fuel valve OFF at the source during draining gasoline from fuel tank before transporting over a long distance or on rough roads.
- Stop the engine before replenishing fuel tank. Never replenish gasoline while the engine is running or remains hot otherwise spilled or evaporated fuel is liable to catch fire from engine sparks or muffler heat. Wipe off spilled fuel, if any, before starting engine. Be careful not to spill fuel.
- Keep inflammables away from the vicinity of the exhaust port. Be careful with gasoline match, straw and other inflammables, since the exhaust port is subjected to a high temperature.

OPERATION

GASOLINE ENGINE STARTING

1. Turn the STOP SWITCH clock-wise to the position "1"(ON).
2. Open the fuel cock.
3. Set the speed control lever 1/3 to 1/2 of the way towards the high speed position.
4. Close the choke lever. If the engine is warm or the ambient temperature is high, open the choke lever half-way, or keep it fully open. If the engine is cold or the ambient temperature is low, close the choke lever fully.
5. Pull the starter handle slowly until resistance is felt. This is the compression point. Return the handle to its original position and pull swiftly. Do not pull out the rope all the way. After starting the engine allow the starter handle to return to its original position while still holding the handle.

DIESEL ENGINE

Turn the throttle lever to START position(open by about 30 degrees See Fig. 5D

Operate Starter

In case of recoil starter. By pulling the starter knob slowly, you will reach such point where resistance become strong(compression point). by pulling it further, you will Find a point where resistance is reduced. Return the knob but slowly return it original.

CAUTION: DO NOT pull the rope all the way and **DO NOT** take your hand off the pulled knob but slowly return it to the original position.

After starting up the engine, be sure to perform a warm up the engine, be sure to perform a warm up run for 2 to 3 minutes. This should be performed without fail, particularly during winter season.

Operation

As the engine warms up, gradually move the choke lever to the OPEN position. Move the speed control lever from the LOW to the HIGH position. When the engine speed reaches approximately 2,300-2,600 RPM, the centrifugal clutch engages. If the engine speed increased very slowly, it is possible that the clutch can slip. Do not operate the speed control lever slowly.

Oil Alert System

The Oil Alert System is designed to prevent engine damage caused by an insufficient amount of oil in the crankcase. Before the oil level in the crankcase can fall below a safe limit the Oil Alert System will automatically stop the engine(the engine switch will remain in the ON position).

NOTE: If the engine stops and will not restart, check the engine oil level.

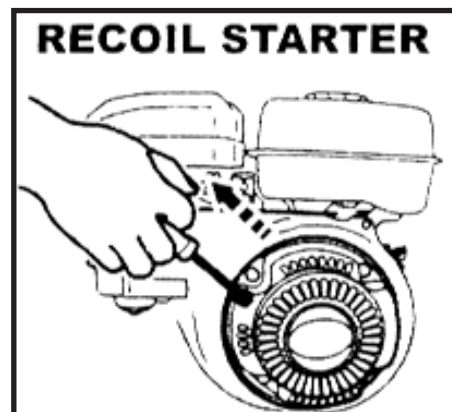
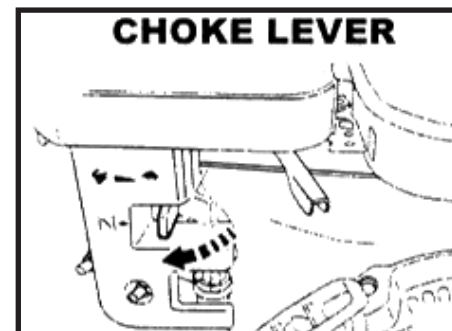
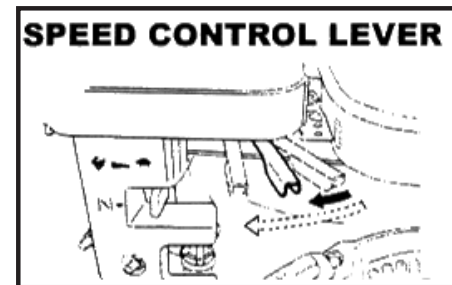
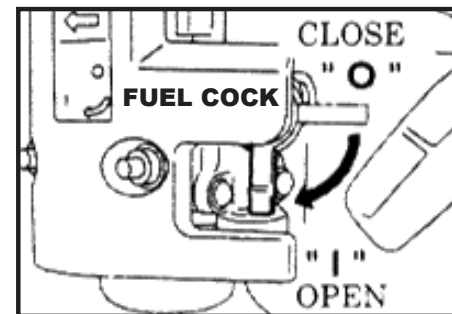
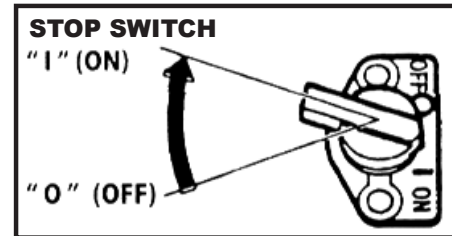
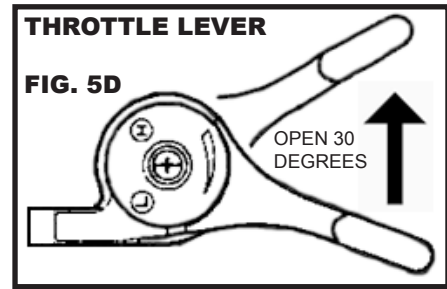

OPERATION

When compacting asphalt, it is advisable to paint the bottom face of the vibrating plate with diesel fuel. This will assist in preventing the plate from sticking to the asphalt. When shutting off the vibrator, turn the speed control lever from the HIGH to LOW position. Do not move the speed control lever slowly.

Transportation

Be sure to stop the engine while transporting. Screw up the fuel tank cap securely and close the fuel valve to avoid fuel leaking. In transportation by car, fix machine securely not to move nor to fall down. In case of driving for long distance or at off-road, tank out fuel from tank.

Shutdown

To stop the engine in an emergency, turn the stop switch to the OFF position. Under normal conditions, use the following procedure. Set the speed control lever at the low speed position and allow the engine to run at low speed for 2 or 3 minutes before stopping. Turn the stop switch to the OFF position. Close the fuel cock.

CAUTION: Flammable liquid: Stop engine and do not smoke or allow work in immediate area when refuelling. Fire or explosion could result from flames or sparks.

Moving Parts: Shutdown engine before performing service or maintenance. Contact with moving parts can cause serious injury.

High Temperature: Allow machine and engine to cool before performing service or maintenance. Contact with hot components can cause serious burns.

Daily Service

- Remove mud, dirt, etc., from the unit.
- Clean bottom face of the vibrating plate
- Check the air cleaner element and clean if necessary
- Check all nuts, bolts, and screws for tightness and re-tighten

Weekly Service

AIR CLEANER SERVICE: Dirty air cleaner element will cause starting difficulty, power loss, engine malfunctions, and shorten engine life extremely. Keep the air cleaner element clean.

URETHANE FOAM ELEMENT: Remove the element and wash it in kerosene or diesel fuel. Then saturate it in a mixture of 3 parts kerosene or diesel fuel and 1 part engine oil. Squeeze the element to remove the mixture and install it in the air cleaner.

URETHANE FOAM DUAL STRUCTURE: Clean the urethane foam in the same way as described above. Wash the element in kerosene or diesel fuel. Saturate it in a mixture of 3 parts kerosene or diesel fuel and 1 part engine oil. Shake off excessive oil and re-install.

SPARK PLUG: Remove spark plug, clean and adjust the spark plug gap to 0.6-0.7mm (0.02-0.03 in.). drain the motor oil of the engine and replace with new specified oil. **NOTE:** When the engine is new, the first oil change must be made after 20 hours of operation.

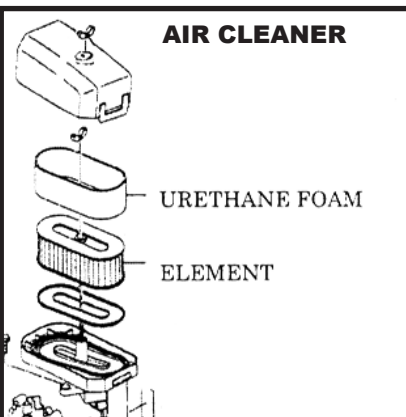
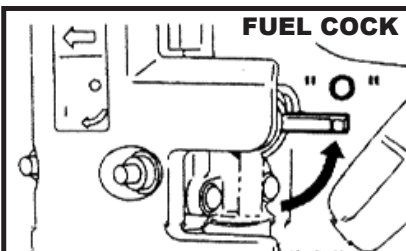
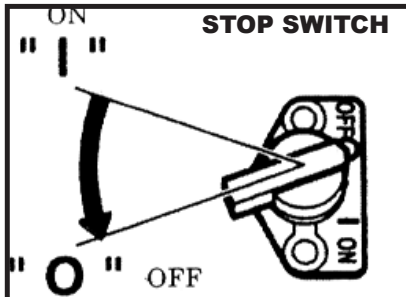
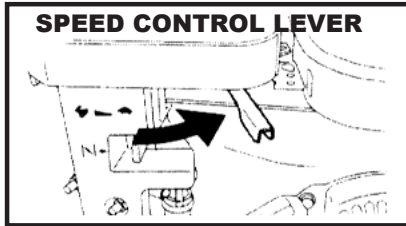
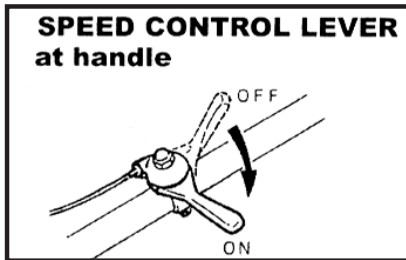
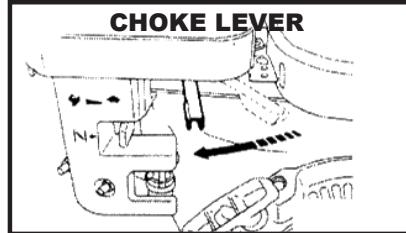
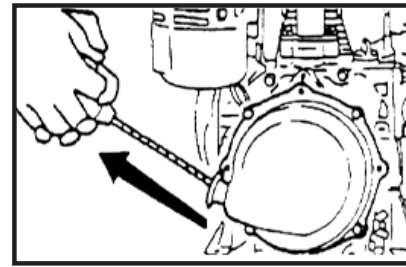

MAINTENANCE

Monthly Service

Change the oil in the vibrator assembly. Storage When storing the compactor for long periods after operation. Thoroughly drain the fuel from the fuel tank fuel pipe and carburetor. Pour a few drops of motor oil into the cylinder by removing the spark plug. Rotate the engine several times by hand so that the cylinder interior is covered with oil. Clean the outer surface of the machine with an oil moistened cloth. Cover the unit and store in a humidity-free, dust-free area.

Care and Preventative Maintenance

Check the oil level in the motor crankcase daily. Check the vibrator oil level weekly. Inspect the rubber anti vibration mounts for wear or deterioration. Clean the underside of the plate regularly to prevent a build up of material.

Service

Change the oil in the motor crankcase regularly to minimise wear. Inspect, clean and/or replace the motor air cleaner regularly, particularly when operating in a dusty environment. Inspect, clean and/or replace the spark plug regularly Check all fasteners for tightness as the machine is subject to vibration. Check vee belt tension, wear and that it is running true, adjust or replace as required.

Vibrator Oil Check

1. Place the plate compactor horizontally on a flat surface. Make sure the compactor is level when checking the oil in the vibrator assembly.
2. Check vibrator oil level by removing the plug(vibrator oil gauge)as shown in The oil level should be up to the oil plug. If oil is required, replace using SAE motor oil, as suggested in the table on page 3.
3. When changing the vibrator oil, remove the drain plug, and simply tip the compactor to drain the oil. Note that the oil will drain more easily while it is hot.

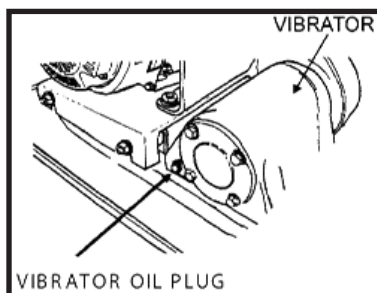
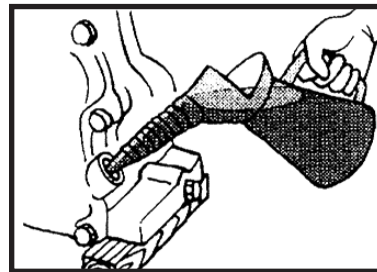
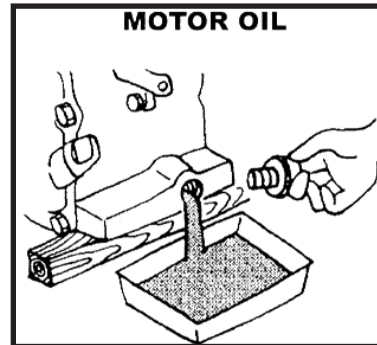
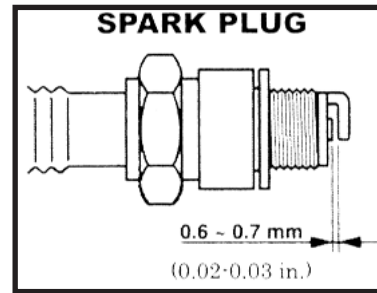

SPECIFICATIONS	
ENGINE	Air-cooled, 4-cycle, single cylinder
ENGINE TYPE	Petrol, CARB Loncin 152F
POWER KW (HP)	1.5 (2.0)
WEIGHT KG (LB)	52 (115)
FREQUENCY (VPM)	5210
CENTRIFUGAL FORCE (KN)	8.5
COMPACTION DEPTH CM (IN)	20 (8)
TRAVEL SPEED CM/S/ (IN/S)	25 (9.8)
EFFICIENCY M2/HR (FT2/HR)	250 (2691)
PLATE SIZE CM (IN)	43X30 (17x11.8)
DIMENSION CM (IN)	72.5X41X60 (28.5X16X24)

Bearings

The following bearings are sealed: Centrifugal clutch-grease lubricated Vibrator-oil bath lubricated

Finish

The machine is finished in gold equipment enamel, the handle in black baked enamel. Exposed metal surfaces are zinc electroplated for corrosion protection.

TROUBLESHOOTING

TROUBLESHOOTING

SYMPTOM	POSSIBLE SOLUTION
MOTOR WILL NOT START	Make sure the ON switch is turned on
	Check the fuel supply
	Check crankcase oil level
	Ensure the spark plug ignition lead is connected
	Check the carburetor jet and bowl, ensure they are clean
MOTOR STOPS	Check the fuel supply
	Check that the fuel cock is turned on
	Check the condition of the air filter
MOTOR LACKS POWER	Check the condition of the air filter
	Check the condition of the spark plug
INSUFFICIENT VIBRATION	Check for a slipping or missing V belt
	Check that the motor speed is 3,500 r/min
MACHINE DOES NOT MOVE FREELY	Check the under side of the plate for build up

PARTS LIST

#	DESCRIPTION	QTY	#	DESCRIPTION	QTY	#	DESCRIPTION	QTY
1	M10*20 bolt	1	20	Spring gasket	4	39	Lock nut	4
2	Spring gasket	1	21	Nut	4	40	Fixed nut for handle	2
3	Flat Gasket	1	22	Outer Hexagon bolt	4	41	Shock absorption on handle	2
4	Key	1	23	Spring gasket	8	42	Bolt	2
5	Pulley	1	24	Flat Gasket	16	43	Outer hexagon bolt	2
6	Cap	1	25	Belt cover	1	44	Flat gasket	2
7	Flat Gasket	8	26	Rotary belt	2	45	Handle gum cover	2
8	Spring gasket	8	27	Outer Hexagon bolt	1	46	Lower handle assy	1
9	Bolt	8	28	Spring gasket	1	47	Throttle lever assy	1
10	O-ring	2	29	Key	1	48	Clamp	1
11	Oil seal	1	30	Clutch assembly	1	49	Bolt for clamp	2
12	Bearing	2	31	Dust Shield	1	50	Lock nut	2
13	Bottom Plate	1	32	Lock nut	12	51	Lock nut	2
14	Copper gasket	2	33	Engine support	1	52	Flat gasket	2
15	Hexagonal oil plug	2	34	Protective frame	1	53	Long wheel screw	1
16	Eccentric shaft	1	35	Outer hexagon bolt	4	54	Wheel assy	1
17	Cap	1	36	Engine	1	55	Upper handle	1
18	Absorber bottom plate	4	37	Outer hexagon bolt	4	56	Flange bolt	2
19	Flat Gasket	4	38	Flat gasket	4	57	Lock nut	2

PARTS DIAGRAM

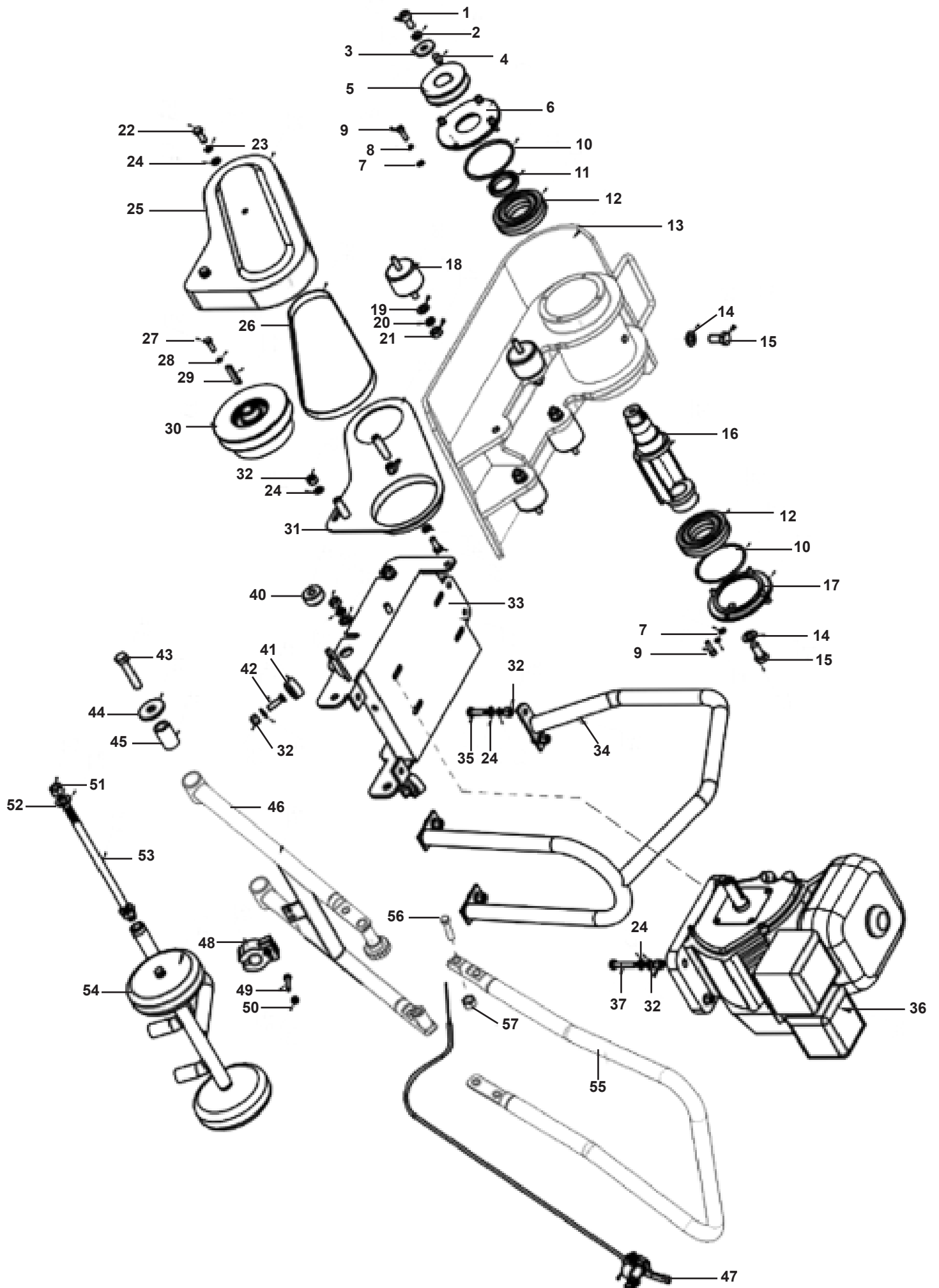

PLEASE READ THE FOLLOWING CAREFULLY

THE MANUFACTURER AND/OR DISTRIBUTOR HAS PROVIDED THE PARTS LIST AND ASSEMBLY DIAGRAM IN THIS MANUAL AS A REFERENCE TOOL ONLY. NEITHER THE MANUFACTURER OR DISTRIBUTOR MAKES ANY REPRESENTATION OR WARRANTY OF ANY KIND TO THE BUYER THAT HE OR SHE IS QUALIFIED TO MAKE ANY REPAIRS TO THE PRODUCT, OR THAT HE OR SHE IS QUALIFIED TO REPLACE ANY PARTS OF THE PRODUCT. IN FACT, THE MANUFACTURER AND/OR DISTRIBUTOR EXPRESSLY STATES THAT ALL REPAIRS AND PARTS REPLACEMENTS SHOULD BE UNDERTAKEN BY CERTIFIED AND LICENSED TECHNICIANS, AND NOT BY THE BUYER. THE BUYER ASSUMES ALL RISK AND LIABILITY ARISING OUT OF HIS OR HER REPAIRS TO THE ORIGINAL PRODUCT OR REPLACEMENT PARTS THERETO, OR ARISING OUT OF HIS OR HER INSTALLATION OF REPLACEMENT PARTS THERETO.

Record Product's Serial Number Here: _____

Note: If product has no serial number, record month and year of purchase instead.

Note: Some parts are listed and shown for illustration purposes only and are not available individually as replacement parts.

WARNING

Read this material before using this product.
Failure to do so can result in serious injury.
SAVE THIS MANUAL.



Questions, problems, missing parts?

Before returning to your retailer, our exceptional customer service is available.

Call us Tel: 909 628 4900

Hour : 9am To 3pm PST (Monday to Friday)

Email : info@starktoolsusa.com