

Installation Guide

for EMCO® Woodcore Self-Storing and Self-Storing Colonial and Traditional Storm Doors with Mortised Handle Set and Retractable Insect Screen



Please Do Not Return Product to Store!

PLEASE call the storm door Solution Center at 1-800-933-3626, with any questions regarding installation, lost part replacement, or anything else related to your storm door purchase.

Read this entire guide before you begin your installation. If your abilities do not match the requirements of this installation, contact an experienced contractor.

PARTS OVERVIEW

Your installation kit should contain the following parts. However, in some door models, not all of the parts will be used.

- A** Rain Cap
- B** Door Frame
- C** Rain Cap Extender
- D** Ventilating Glass Panel
- E** Hinge Rail with 4 hinges
(Hinge Side Z-bar)
- F** Insect Screen
- G** Latch Rail
(Handle Side Z-bar)
- H** Sweep
- I** Sweep fin
- J** Side Screw Covers (2)
- K** Top Screw Cover (1)
- L** Hinge Rail Shim
- M** Edge Seal

Not Shown

- N** Screen Shipping Clip
- O** Installation Kit
(Pink, Clear & Green Parts
Bags Inside)
- P** Window Handle Kit
(If Applicable)
- Q** Latch Side Spacer Clip
- R** Sill Spacer Clip
- S** Slot Cover

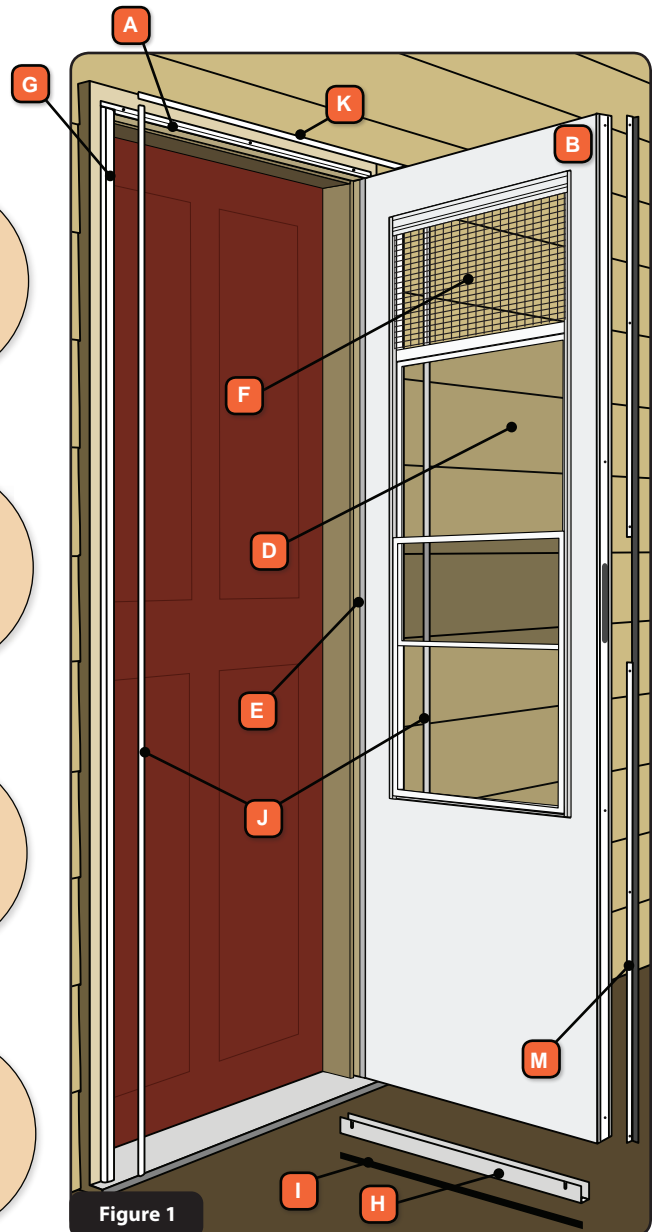
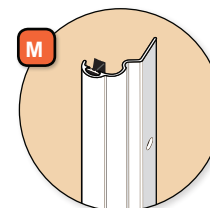
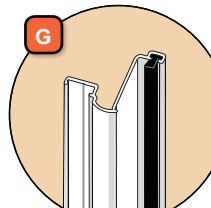
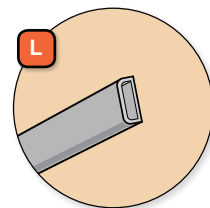
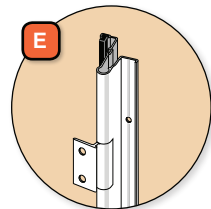
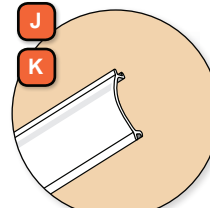
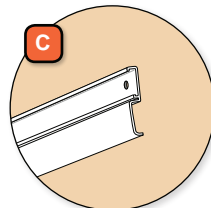
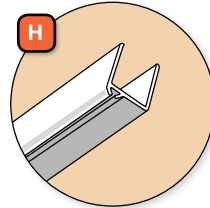
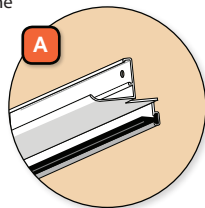

Figure 1

EMCO®

EMCO Enterprises, Inc., is a wholly owned subsidiary of Andersen Corporation. EMCO manufactures and supports the limited warranties for Andersen® and EMCO® doors. "Andersen", "EMCO" and all other marks where denoted are trademarks of Andersen Corporation. ©2014 Andersen Corporation. All rights reserved.

Andersen SDD, PO Box 853
Des Moines, IA 50306-0853
Rev 1-2014 12088 Print in Color

p/n 504119

SAFETY FIRST: Please read and follow all Cautions and Warnings in this guide.

WARNING
Entry door hardware and handle may become hot when exposed to sunlight.

WARNING
Metal fasteners and other hardware components may corrode when exposed to preservative treated and fire-retardant treated lumber. Obtain and use the appropriate size stainless steel fasteners and hardware as called out by the installation guide to fasten unit to any rough opening made from pressure treated and fire-retardant treated lumber. Failure to use the appropriate materials for the installation may cause a failure resulting in injury, property or product damage.

WARNING
Improper use of hand or power tools could result in injury and/or product damage. Follow equipment manufacturer's instructions for safe operation. Always wear safety glasses.

WARNING
Windows and doors can be heavy. Use safe lifting techniques and a reasonable number of people with enough strength to lift, carry, and install window and door products to avoid injury and/or property damage.

WARNING
The insect screen is intended for reasonable insect control and not the retention of objects or persons within the interior. The insect screen material will not stop a person from falling through the door.

RECOMMENDED TOOLS

1 VERIFY MOUNTING REQUIREMENTS

Verify that the exterior brick mold, trim board or casing is firmly attached to the opening. The storm door will sag over time if the mounting surface is not sufficiently fastened to the entryway.

To install the storm door, you must verify that the opening width, height and mounting surface are sufficient.

1. Measure the width at the top, middle, and bottom of the opening (Figure 2). Measure from the inside of the brick mold or exterior trim. Refer to Table 1.
2. Measure the height at the center of the opening. Measure from the inside of the brick mold or exterior trim, down to the top of the bottom sill. Refer to Table 1.

Nominal Storm Door Sizes **	Opening Sizes	
	W 1 - 3 (width) *	H (height)
36" x 80"	35 3/4" TO 36 3/8"	80" TO 81"
34" x 80"	33 3/4" TO 34 3/8"	
33" x 80"	32 3/4" TO 33 3/8"	
32" x 80"	31 3/4" TO 32 3/8"	

Table 1:
Use this table to determine if your storm door will fit into the opening:

3. Make sure that the brick mold or exterior trim meets the mounting surface requirements to install the rain cap, hinge rail and latch rail (Figure 3). You must have a minimum of:
 - 1" mounting surface depth. *
 - 3/4" mounting surface front. *
 - 2 1/2" handle clearance

* For opening widths up to 1" wider or for mounting surface depth between 5/8" - 3/4", please call our Solution Center at 1-800-933-3626 to purchase a special kit to accommodate your situation.

** Nominal storm doors sizes are listed. The actual storm door frame width and height will be less. Example: A nominal size of 36" x 80" may have an actual storm door frame size of 35 1/8" x 79 1/8".

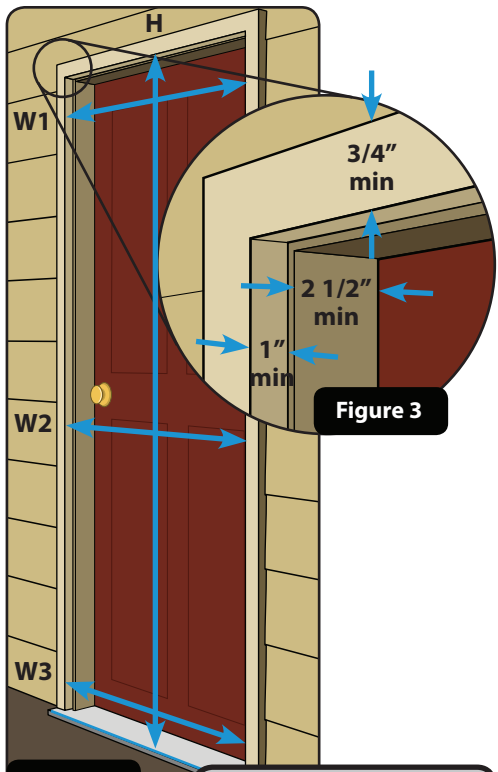

Figure 2

Figure 3

INTERIOR VIEW
VISTA INTERIOR = VIEW
VUE DE L'INTÉRIEUR

EXTERIOR VIEW
VISTA EXTERIOR = VIEW
VUE DE L'EXTÉRIEUR

2

INSTALLATION PREPARATION

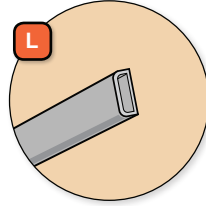
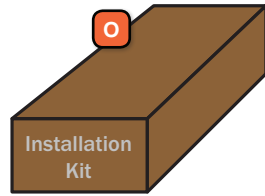

Tools needed:

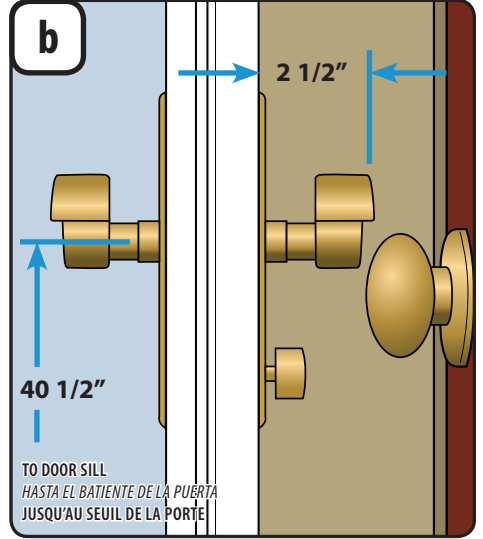

1. Most homeowners prefer to have the storm door handle on the same side as the entry door handle. In shallow door openings, this can cause the two handles to interfere. Check for potential interference using the rough measurements. If you anticipate that there will be interference, hand the storm door on the opposite side of your entry door. See page 2, Figure 3 for detailed hardware depth requirements.

C

Determine if Hinge Rail Shim is needed

Nominal Storm Door Sizes	Shim needed if opening width is:
36" x 80"	36 1/8" TO 36 3/8"
34" x 80"	34 1/8" TO 34 3/8"
33" x 80"	33 1/8" TO 33 3/8"
32" x 80"	32 1/8" TO 32 3/8"

IF REQUIRED
SI FUERA NECESARIO
SI NÉCESSAIRE

Tape x 4

1. Use the table above to determine if you need to use the provided hinge rail shim (L).
2. If your opening width falls within the dimensions listed, you will need to install the shim. If your opening width does not fall within these dimensions, proceed to **step 3**.
3. Remove any debris from the mounting surface where the hinge rail shim (L) will be attached.
4. Apply the four strips of double stick tape from the pink bag to the shim, spacing them evenly along the entire length. Attach the shim to the mounting surface, as shown.

3

PREPARE STORM DOOR FOR INSTALLATION (Left Hand)

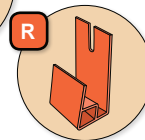
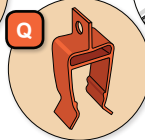
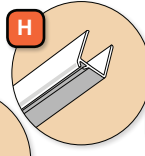
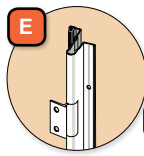

Tools needed:

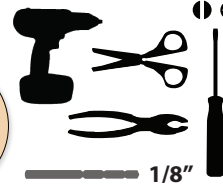

PINK BAG / BOLSA ROSA / SAC ROSE

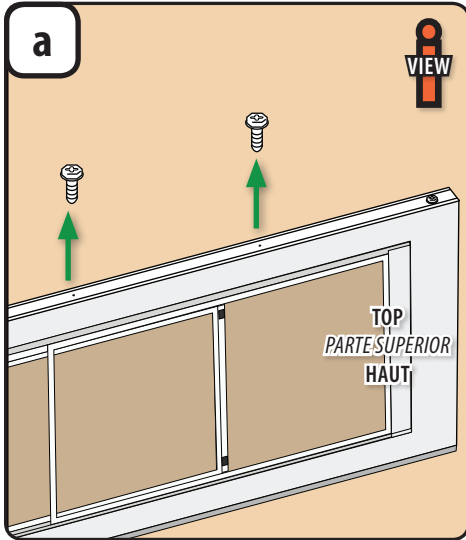
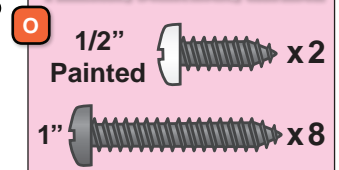

1. Place the latch side edge of door frame on the ground. TIP: Lay on door carton.
2. Identify the top of the hinge rail (E).
3. Remove the two middle hex head screws from the hinge side edge of door frame.

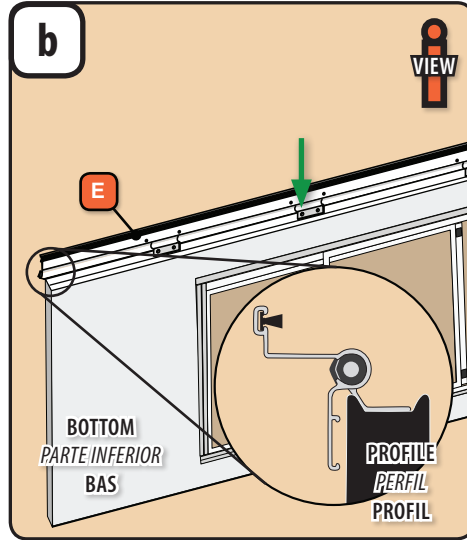

1. Position hinge rail along hinge-side edge of door frame so bottom hole of the 2nd hinge up from the bottom lines up with bottom hole from the screws removed in **step 3a**. **NOTE:** Top of hinge rail should extend approximately 3/16" beyond top of door frame.
2. Using the 1/8" drill bit from the pink bag, pre-drill 1" deep pilot holes in door frame at each hinge and fasten using 1" unpainted screws from the pink bag in the installation kit.

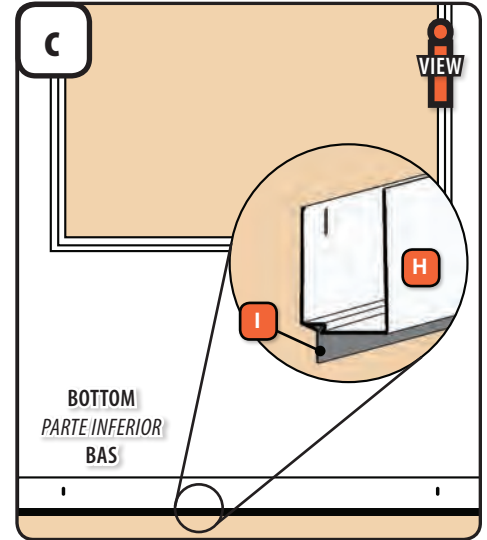

1. Slide sweep fin (I) into track in sweep (H). Crimp both ends of track to secure the fin. Trim off excess sweep fin material and properly discard.
2. Install door sweep so it is centered across width of door frame and pressed tight against bottom of door frame.
3. Center punch and then pre-drill 1/8" pilot holes at the bottom of the slot for future adjustment, then attach the sweep using painted 1/2" screws from the pink bag.

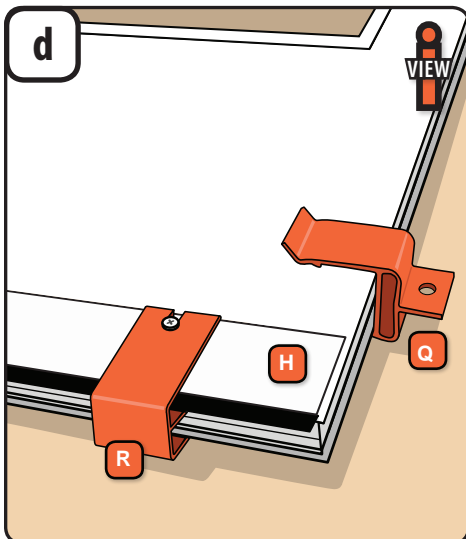

1. Install the sill spacer clip (R) under the latch side sweep screw and tight against the bottom of the sweep. Tighten the sweep screw to retain the sill spacer clip in place.
2. Install the latch side spacer clip (Q) over the latch side of the door frame as shown. This clip should be approximately 6" from the bottom of the door frame.

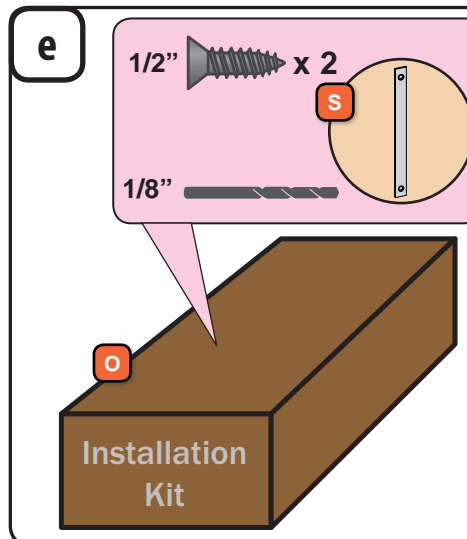

1. Find the Installation Kit (O) located inside the door carton and identify the slot cover (S), the color matched 1/2" flat head screws, and the 1/8" drill bit found in the pink bag.
2. Do not remove the insert located inside of the hinge side pocket.
3. Hold the slot cover over the hinge side pocket of the door frame edge. Make sure hinge side pocket is fully covered by cover plate. Mark the two mounting screw locations.
4. Using a drill and 1/8" drill bit, drill a hole in the marked locations. Install the slot cover with the two 1/2" painted flat head screws.

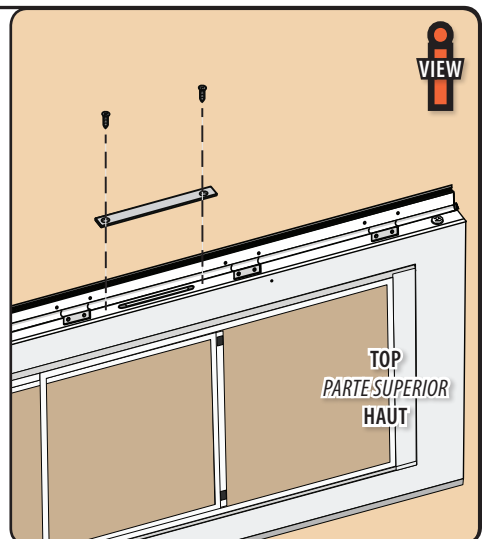

4

INSTALL HINGED STORM DOOR IN OPENING (Left Hand)

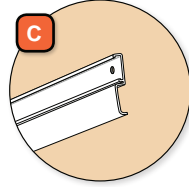
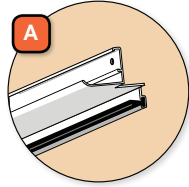

Tools needed:

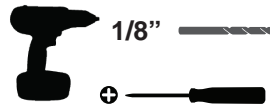

YELLOW BAG // BOLSA AMARILLA // SAC JAUNE

1" x 19

3/16" Plug x 1



1. Set the door frame on the entry sill so the hinge rail is tight against the mounting surface (or hinge rail shim) and the sill spacer clip (R) is sitting on the door sill.
2. Tip the top of the door frame into the opening, making sure that the sill spacer clip is still on the door frame and resting on the sill.

NOTE: Door may be out of square at this time.

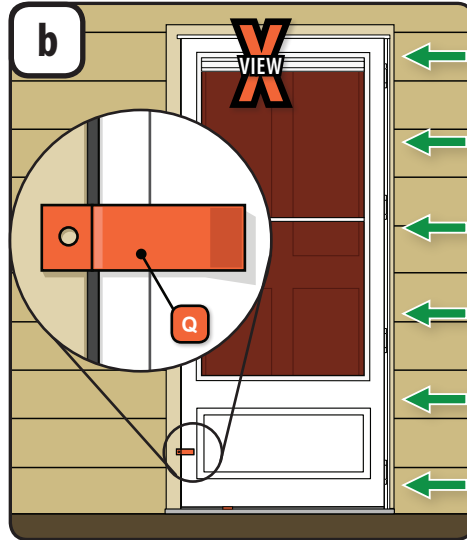

1. The door frame is properly seated in the opening when the hinge rail and latch side spacer clip (Q) are flush against the mounting surface and the mounting surface completely fills the hole in the latch side spacer clip. If the latch side spacer clip hole is not completely filled, review **step 2c**.
2. Pre-drill pilot holes using drill bit, then use 1" screws from yellow bag in the installation kit to fasten hinge rail to mounting surface.

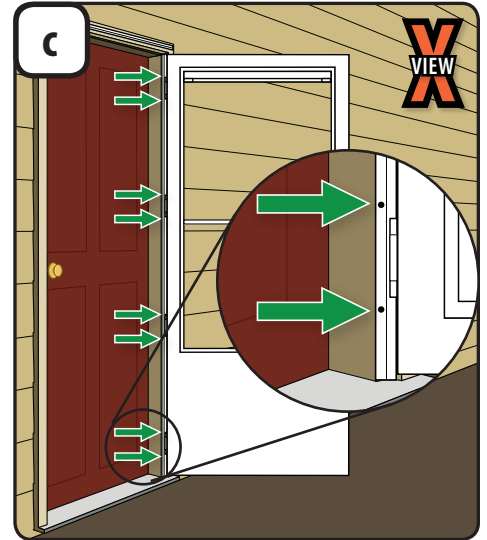

1. Open the storm door.
2. Pre-drill and fasten the hinge rail to the door jamb using 1" screws from the yellow bag.
3. Remove both orange clips from the bottom of the door frame and properly discard.

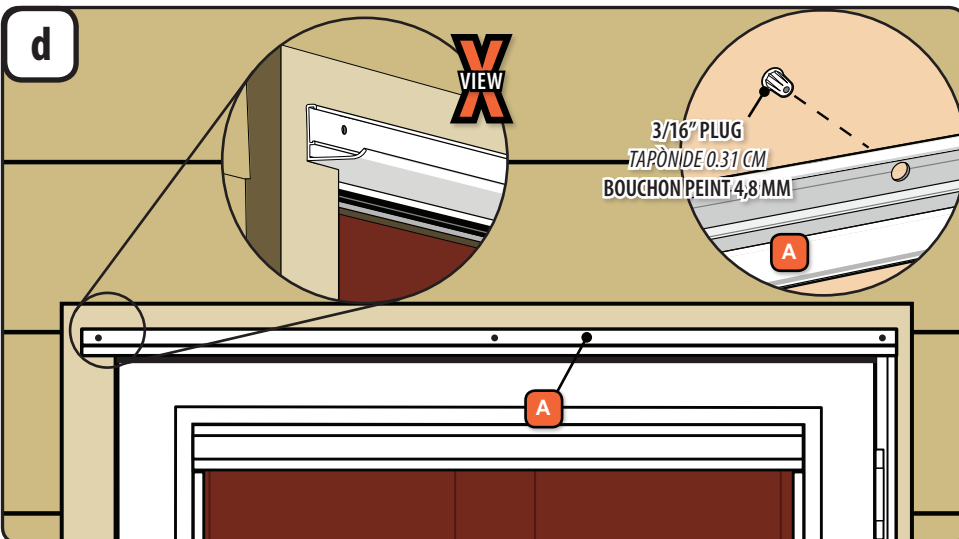

1. Open the storm door. Place the rain cap (A) in the opening so that it rests on top of the hinge rail, aligning the end of the the rain cap with the edge of the hinge rail.
2. Close the storm door. Adjust rain cap to achieve an even gap between the top of the door frame.
3. Look at the center hole of the rain cap. If the mounting surface can be seen in the entire hole, proceed to **step 4e**. If the mounting surface cannot be seen in the entire hole, or if there is space above the rain cap, then remove the rain cap.
4. From the mounting surface (back) side of the rain cap, completely insert a 3/16" plug from the yellow bag into the middle hole.
5. Re-install the rain cap as described above.

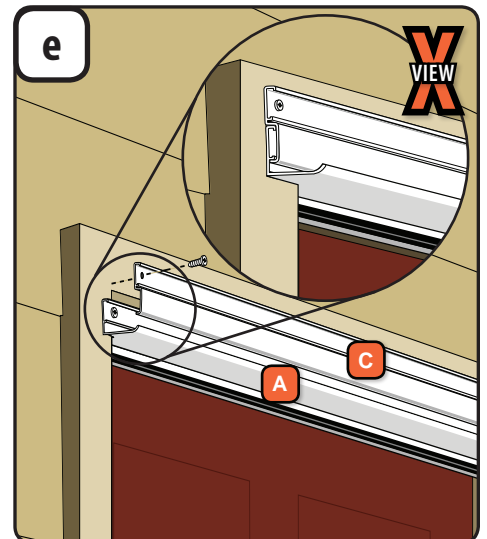

1. Using the drill bit and 1" screws from the yellow bag, fasten the rain cap to the mounting surface.
2. If a plug was installed in the middle hole, you will need to install the rain cap extender (C).
3. Place the rain cap extender over the rain cap as shown, with both ends being flush.
4. Using the drill bit and 1" screws from the yellow bag in the installation kit, fasten the rain cap extender to the mounting surface.

5

INSTALL LATCH RAIL (Left Hand)

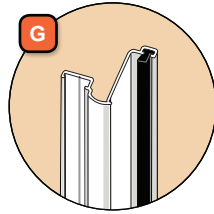

Tools needed:

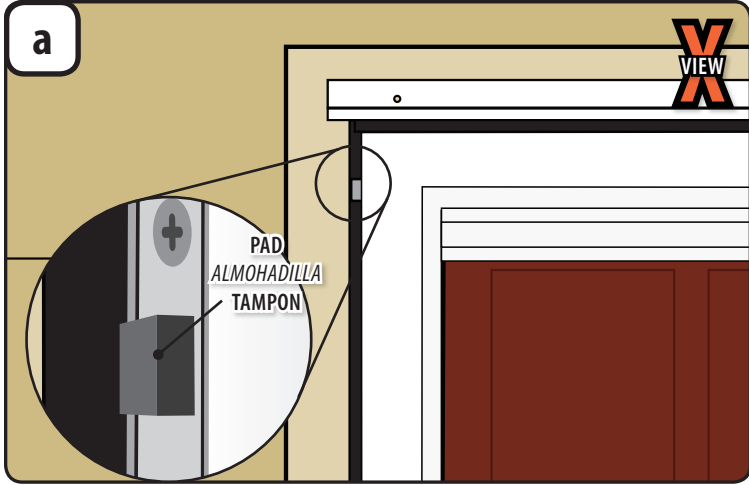
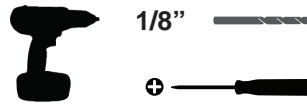

1. Find the three 1/2" square adhesive backed spacer pads in the yellow bag in the installation kit.
2. Swing door open and wipe off any residue on edge of door.
3. Peel the paper backer off each pad and attach them to the latch side door edge. Position one approximately 6" down from the top of the door, another close to the center of the door, and the third approximately 6" up from the bottom.

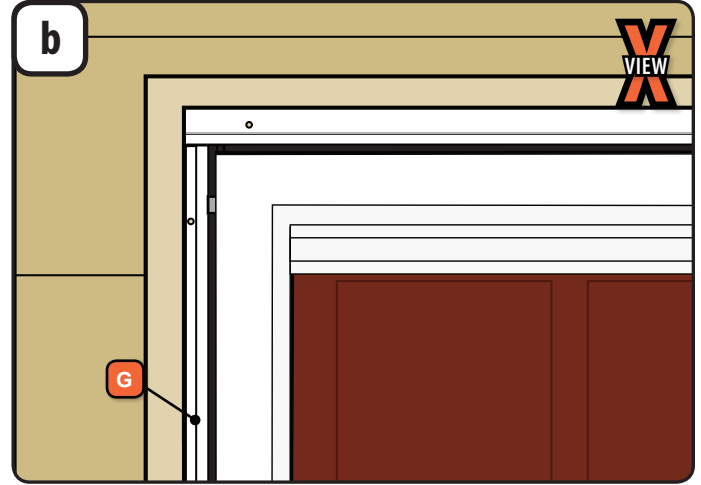

1. Place latch rail (G) in the opening with top end pushed up against rain cap.
2. Close storm door and slide latch rail towards door frame until it contacts all three spacer pads, creating a 3/16" gap.
3. Using drill bit and 1" screws from the yellow bag, fasten latch rail to mounting surface.
4. Open storm door and remove spacer pads, then properly discard.

6

INSTALL THE WINDOW HANDLE (Left Hand)

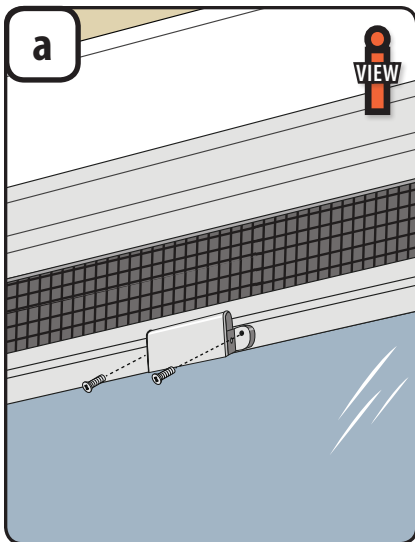
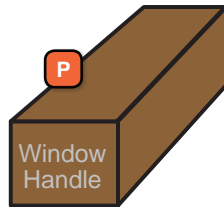

1. Lower or raise the ventilating glass panel so that the holes below the insect screen are at a comfortable working height.
2. **If applicable**, refer to the instructions included in the Window Handle Kit (P) to install the window handle.

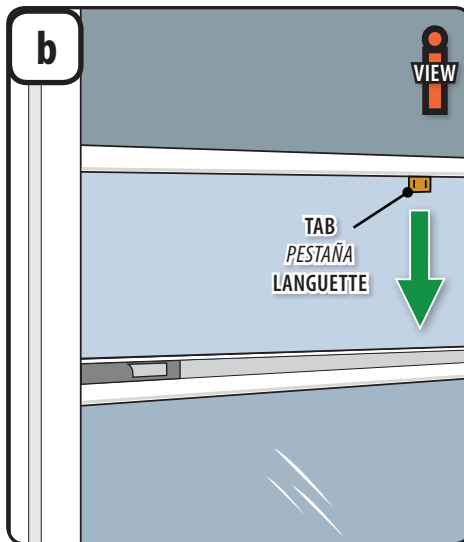

- If installing a door without a window handle:**
1. Lower insect screen by pulling down on orange insect screen helper tab. Once screen is exposed, grab and hold in hand.
 2. Remove helper tab by twisting and pushing it outwards.

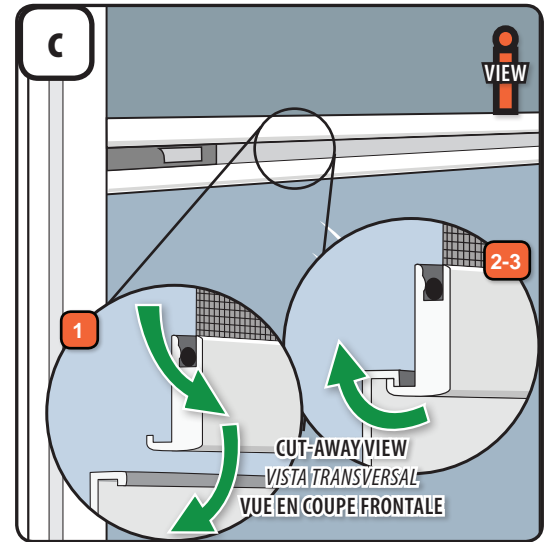

1. When you reach top of ventilating glass panel, a slight pull towards you will allow insect screen pull lip to maneuver around ventilating glass panel rail.
2. A slight push away from you will align lip and rail.
3. Raise insect screen lightly. Screen will be fully engaged when ventilating glass panel rail is interlocked with insect screen lip.

7 INSTALL HANDLE SET & CLOSER (Left Hand)

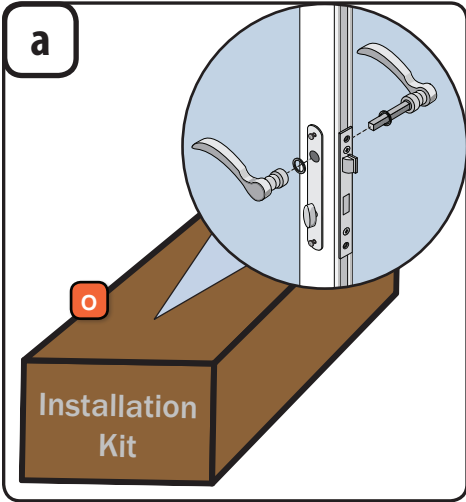

1. Refer to the instructions included in the Installation Kit (O) to drill the handle holes and to install the door handles and closer.

8 IF NECESSARY, ADJUST THE SWEEP (Left Hand)

Tools needed:

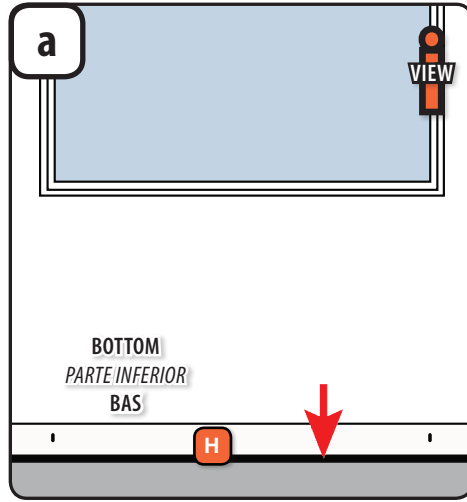

1. Close the storm door.
2. From the interior, loosen the sweep screws with a phillips screw driver. Adjust the sweep (H) up or down until the sweep fin lightly comes into contact with the door sill.
3. Retighten the sweep screws.

9 FILE EDGE SEAL (Left Hand)

Tools needed:

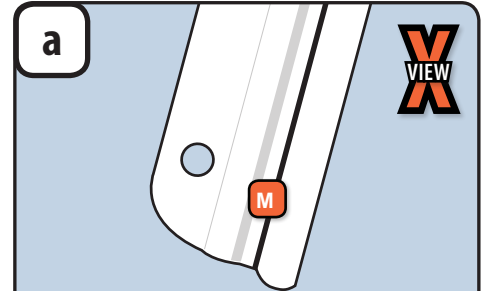

WARNING

Generously round the bottom corner of the edge seal with a metal file to avoid sharp edges. Failure to round the bottom corners may cause an injury.

1. File the bottom corners of the edge seal (M) until they are smooth.

10 INSTALL EDGE SEAL (Left Hand)

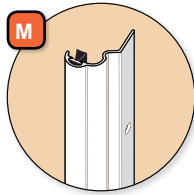

Tools needed:

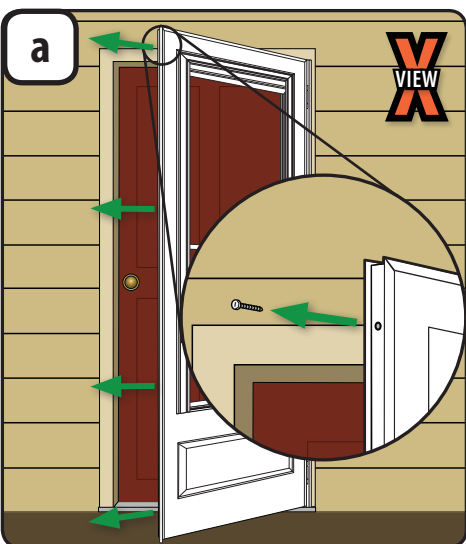

1. Open the door and remove all four hex head screws from the edge of the door, then properly discard screws.

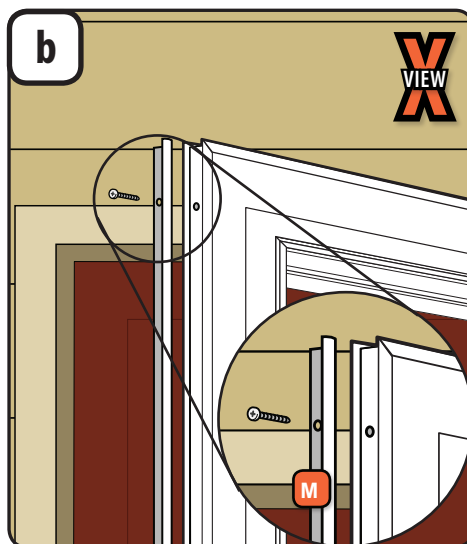

1. Align first hole down on edge seal with top hole in edge of door and install a 1" painted screw from yellow bag.

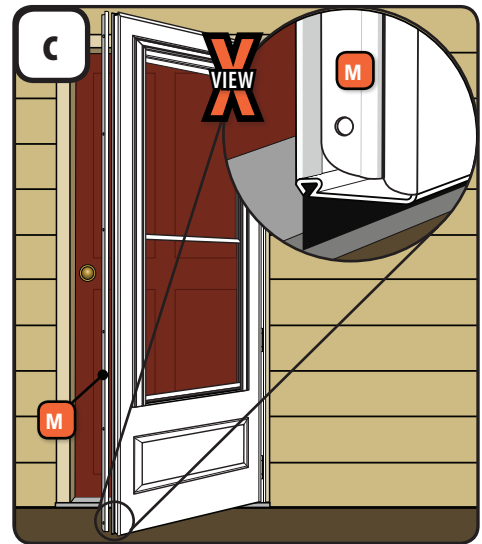

1. Pre-drill 1" deep pilot holes in door frame through pre-drilled holes in edge seal.
2. Fasten edge seal to door frame using five 1" painted screws from yellow bag.

11

INSTALL SCREW COVERS (Left Hand)

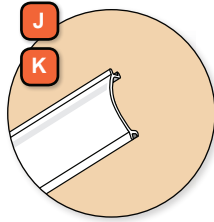

Tools needed:

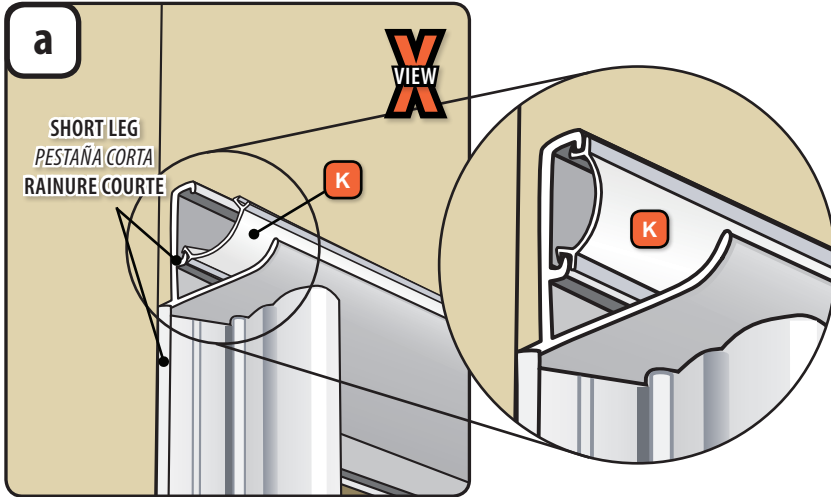

1. Lock leg of screw cover (K) into short leg of rain cap screw track. Press on other leg to snap it into long leg of track. Make sure screw cover snaps into screw track along the entire length of the rain cap.
2. Repeat this process with remaining side screw covers.
3. Using scissors, trim off any excess that may remain.

12

PREPARE STORM DOOR FOR INSTALLATION (Right Hand)

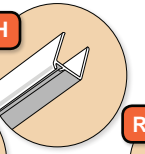
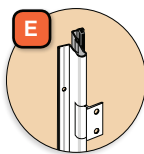

Tools needed:

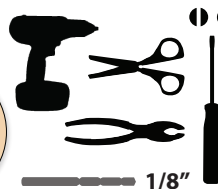

PINK BAG / BOLSA ROSA / SAC ROSE

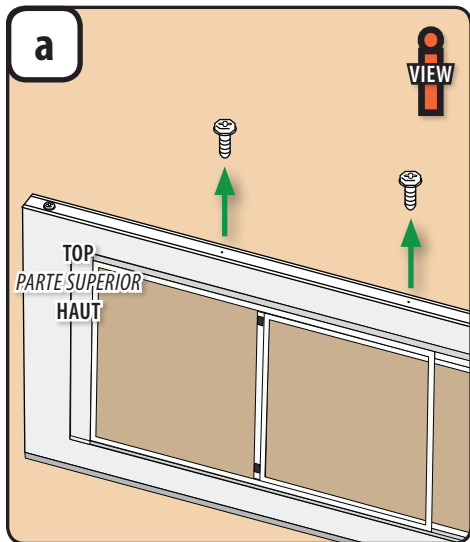
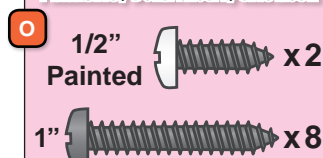

1. Place the latch side edge of door frame on the ground. TIP: Lay on door carton.
2. Identify the top of the hinge rail (E).
3. Remove the two middle hex head screws from the hinge side edge of door frame.

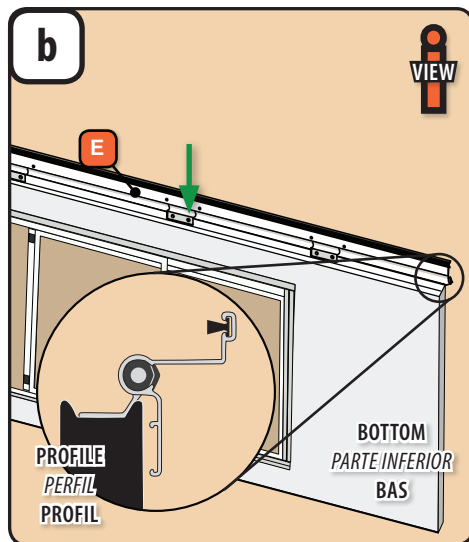

1. Position the hinge rail along the hinge-side edge of the door frame so the bottom hole of the 2nd hinge up from the bottom lines up with the bottom hole from the screws removed in **step 12a**. NOTE: The top of the hinge rail should extend approximately 3/16" beyond the top of the door frame.
2. Pre-drill 1" deep pilot holes in door frame at each hinge and fasten using 1" unpainted screws from the pink bag in the installation kit.

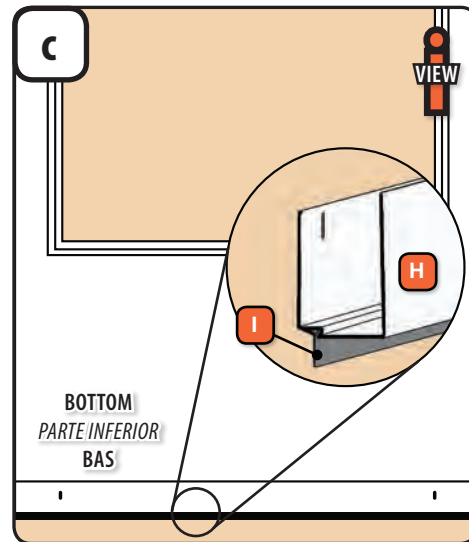

1. Slide sweep fin (I) into track in sweep (H). Crimp both ends of track to secure the fin. Trim off excess sweep fin material and properly discard.
2. Install door sweep so it is centered across width of door frame and pressed tight against bottom of door frame.
3. Center punch and then predrill 1/8" pilot holes at the bottom of the slot for future adjustment, then attach the sweep using painted 1/2" screws from the pink bag.

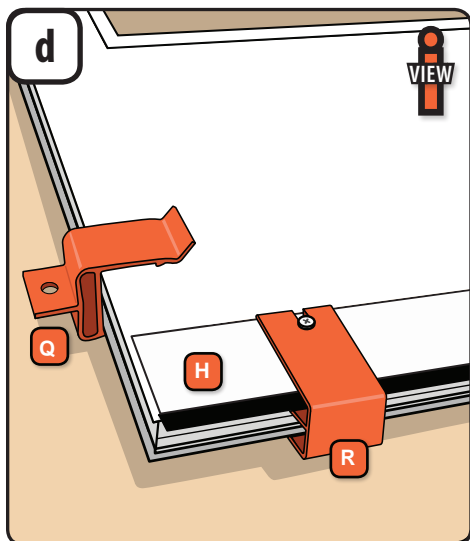

1. Install the sill spacer clip (R) under the latch side sweep screw and tight against the bottom of the sweep. Tighten the sweep screw to retain the sill spacer clip in place.
2. Install the latch side spacer clip (Q) over the latch side of the door frame as shown. This clip should be approximately 6" from the bottom of the door frame.

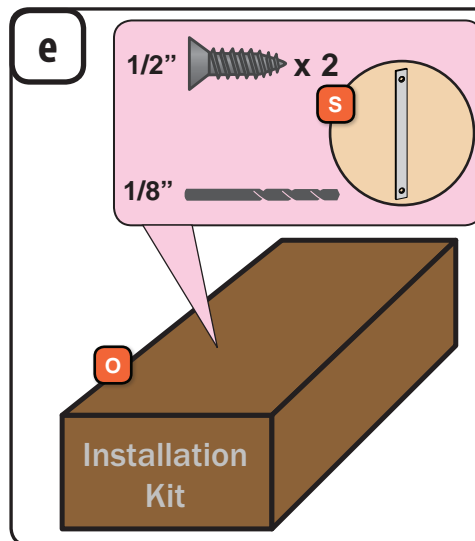

1. Find the Installation Kit (O) located inside the door carton and identify the slot cover (S), the color matched 1/2" flat head screws, and the 1/8" drill bit found in the pink bag.
2. Do not remove the insert located inside of the hinge side pocket.
3. Hold the slot cover over the hinge side pocket of the door frame edge. Make sure hinge side pocket is fully covered by cover plate. Mark the two mounting screw locations.
4. Using a drill and 1/8" drill bit, drill a hole in the marked locations. Install the slot cover with the two 1/2" painted flat head screws.

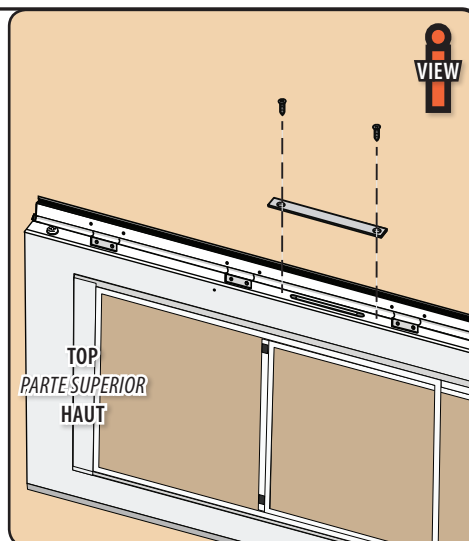

13

INSTALL HINGED STORM DOOR IN OPENING (Right Hand)

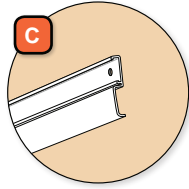
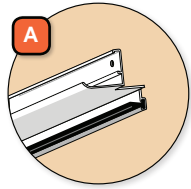

Tools needed:



YELLOW BAG / BOLSA AMARILLA / SAC JAUNE

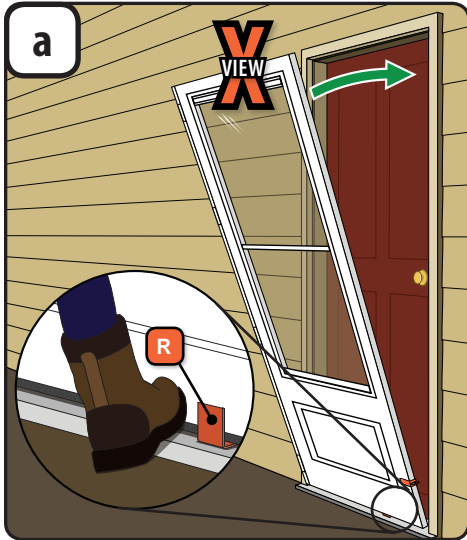

1. Set the door frame on the entry sill so the hinge rail is tight against the mounting surface (or hinge rail shim) and the sill spacer clip (R) is sitting on the door sill.
2. Tip the top of the door frame into the opening, making sure that the sill spacer clip is still on the door frame and resting on the sill.

NOTE: Door may be out of square at this time.

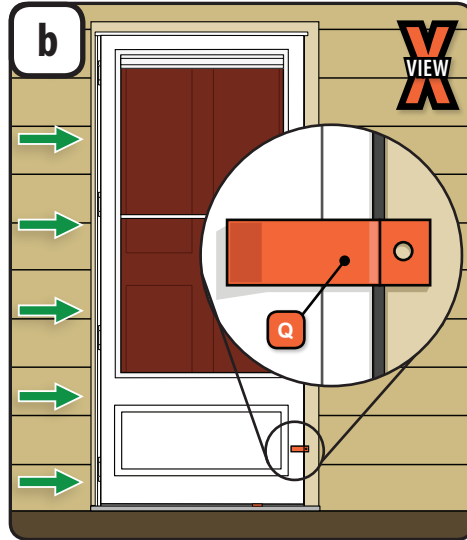

1. The door frame is properly seated in the opening when the hinge rail and latch side spacer clip (Q) are flush against the mounting surface and the mounting surface completely fills the hole in the latch side spacer clip. If the latch side spacer clip hole is not completely filled, review **step 2c**.
2. Pre-drill pilot holes using drill bit, then use 1" screws from yellow bag in the installation kit to fasten hinge rail to mounting surface.

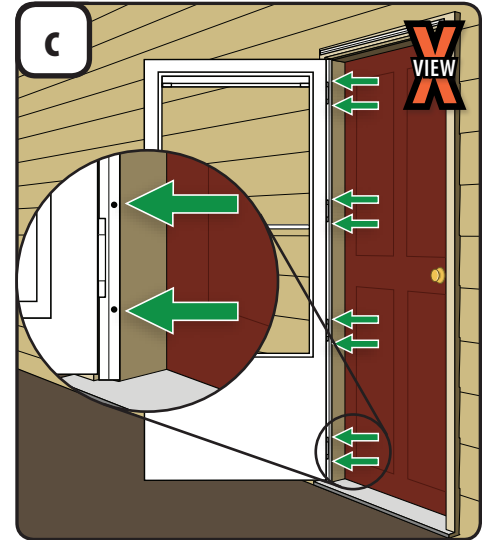

1. Open the storm door.
2. Pre-drill and fasten the hinge rail to the door jamb using 1" screws from the yellow bag.
3. Remove both orange clips from the bottom of the door frame and properly discard.

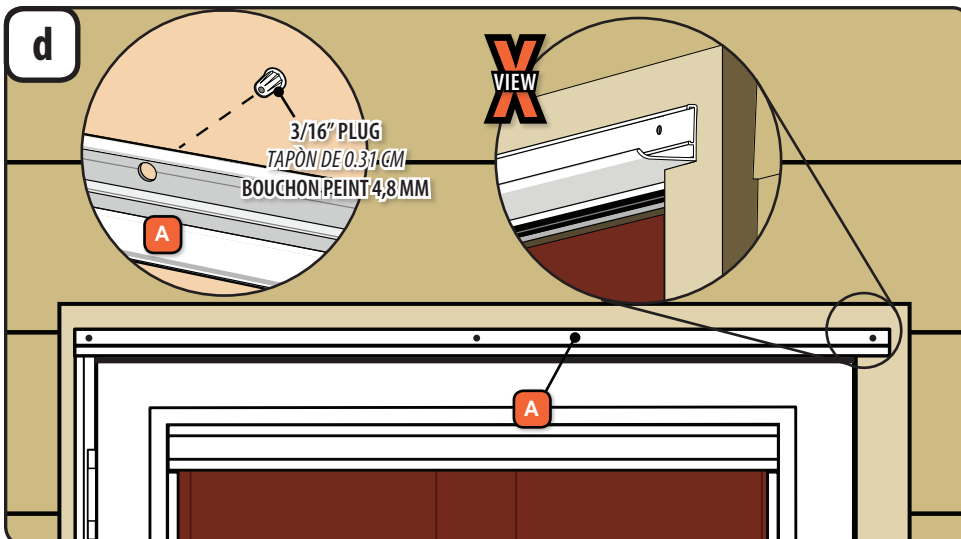

1. Open the storm door. Place the rain cap (A) in the opening so that it rests on top of the hinge rail, aligning the end of the the rain cap with the edge of the hinge rail.
2. Close the storm door. Adjust rain cap to achieve an even gap between the top of the door frame.
3. Look at the center hole of the rain cap. If the mounting surface can be seen in the entire hole, proceed to **step 13e**. If mounting surface cannot be seen in the entire hole, or if there is space above the rain cap, then remove the rain cap.
4. From the mounting surface (back) side of the rain cap, completely insert a 3/16" plug from the yellow bag into the middle hole.
5. Re-install the rain cap as described above.

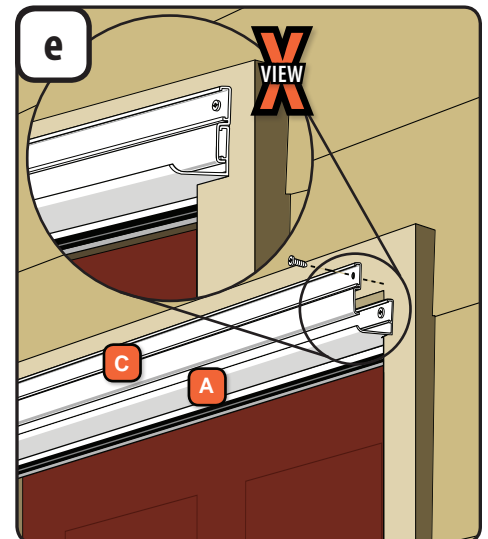

1. Using the drill bit and 1" screws from the yellow bag, fasten the rain cap to the mounting surface.
2. If a plug was installed in the middle hole, you will need to install the rain cap extender (C).
3. Place the rain cap extender over the rain cap as shown, with both ends being flush.
4. Using the drill bit and 1" screws from the yellow bag in the installation kit, fasten the rain cap extender to the mounting surface.

14

INSTALL LATCH RAIL (Right Hand)

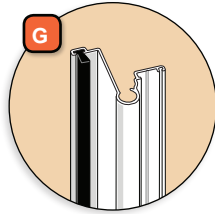

Tools needed:

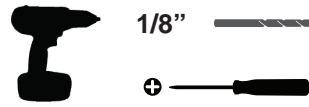

YELLOW BAG / BOLSA AMARILLA / SAC JAUNE

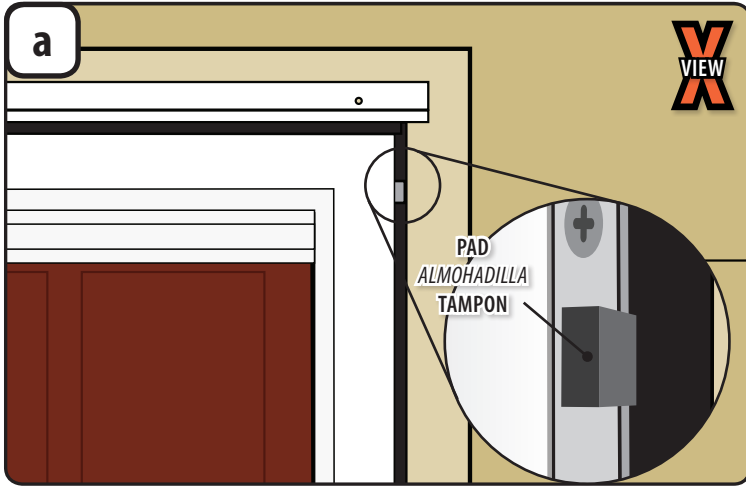
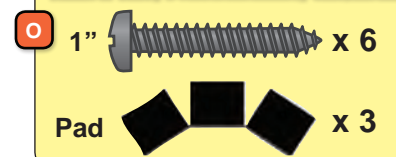

1. Find the three 1/2" square adhesive backed spacer pads in the yellow bag in the installation kit.
2. Swing door open and wipe off any residue on edge of door.
3. Peel the paper backer off each pad and attach them to the latch side door edge. Position one approximately 6" down from the top of the door, another close to the center of the door, and the third approximately 6" up from the bottom.

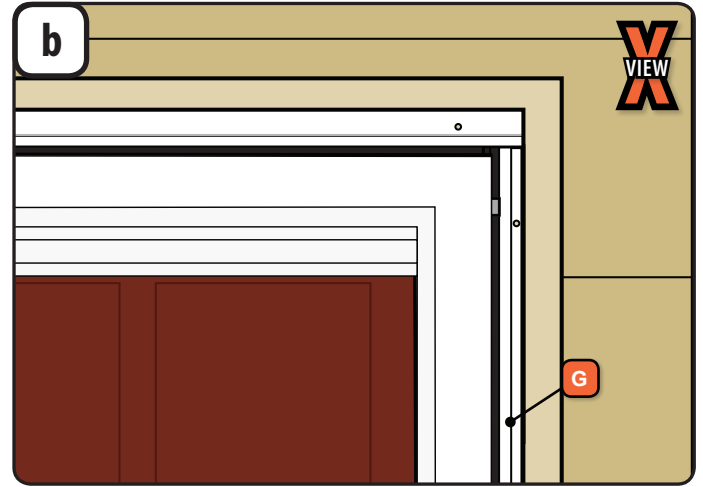

1. Place latch rail (G) in the opening with top end pushed up against rain cap.
2. Close storm door and slide latch rail towards door frame until it contacts all three spacer pads, creating a 3/16" gap.
3. Using drill bit and 1" screws from the yellow bag, fasten latch rail to mounting surface.
4. Open storm door and remove spacer pads, then properly discard.

15

INSTALL THE WINDOW HANDLE (Right Hand)

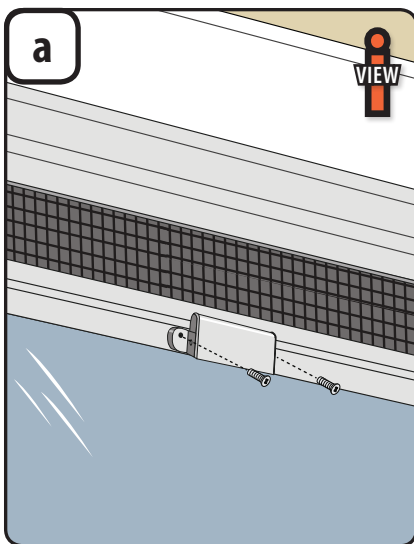
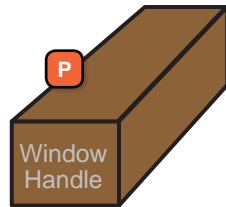

1. Lower or raise the ventilating glass panel so that the holes below the insect screen are at a comfortable working height.
2. **If applicable**, refer to the instructions included in the Window Handle Kit (P) to install the window handle.

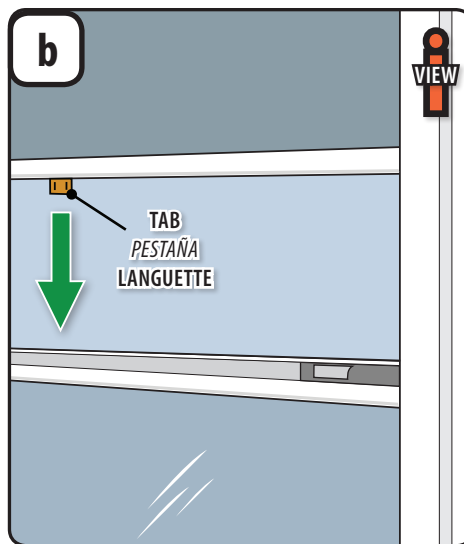

If installing a door without a window handle:

1. Lower insect screen by pulling down on orange insect screen helper tab. Once screen is exposed, grab and hold in hand.
2. Remove helper tab by twisting and pushing it outwards.

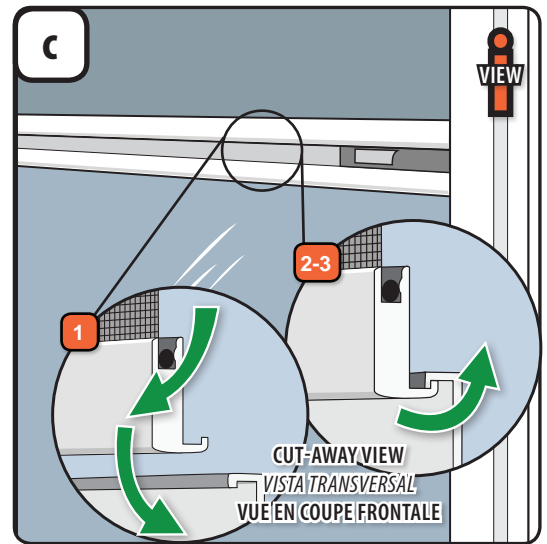

1. When you reach top of ventilating glass panel, a slight pull towards you will allow insect screen pull lip to maneuver around ventilating glass panel rail.
2. A slight push away from you will align lip and rail.
3. Raise insect screen lightly. Screen will be fully engaged when ventilating glass panel rail is interlocked with insect screen lip.

16 INSTALL HANDLE SET AND CLOSER (Right Hand)

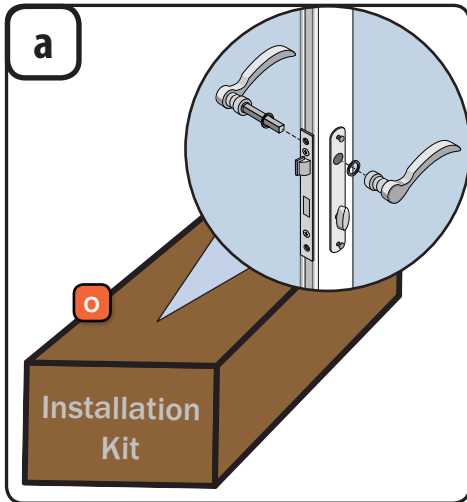

1. Refer to the instructions included in the Installation Kit (O) to drill the handle holes and to install the door handles and closer.

17 IF NECESSARY, ADJUST THE SWEEP (Right Hand)

Tools needed:

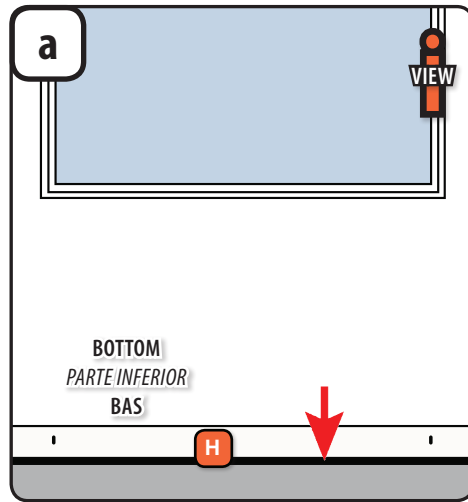

1. Close the storm door.
2. From the interior, loosen the sweep screws with a phillips screw driver. Adjust the sweep (H) up or down until the sweep fin lightly comes into contact with the door sill.
3. Retighten the sweep screws.

18 FILE EDGE SEAL (Right Hand)

Tools needed:

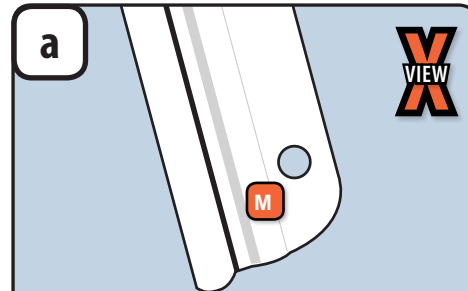
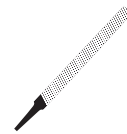

WARNING

Generously round the bottom corner of the edge seal with a metal file to avoid sharp edges. Failure to round the bottom corners may cause an injury.

1. File the bottom corners of the edge seal (M) until they are smooth.

19 INSTALL EDGE SEAL (Right Hand)

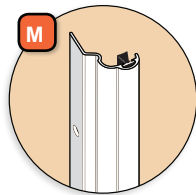

Tools needed:



1/8"

YELLOW BAG / BOLSA AMARILLA / SAC JAUNE



1" x 6

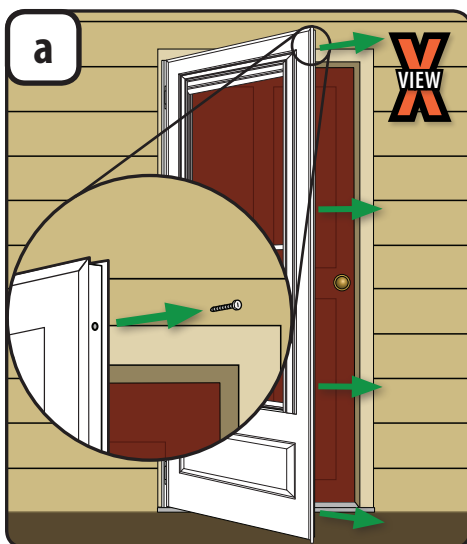

1. Open the door and remove all four hex head screws from the edge of the door, then properly discard screws.

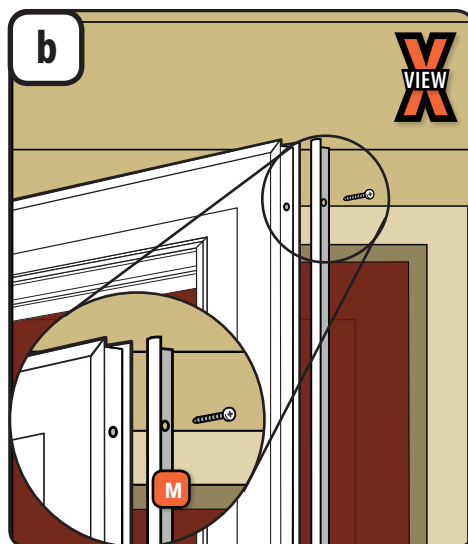

1. Align first hole down on edge seal with top hole in edge of door and install a 1" painted screw from yellow bag.

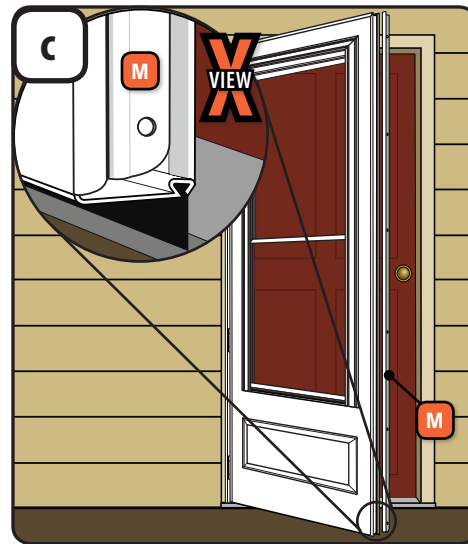

1. Pre-drill 1" deep pilot holes in door frame through pre-drilled holes in edge seal.
2. Fasten edge seal to door frame using five 1" painted screws from yellow bag.

20

**INSTALL
SCREW
COVERS
(Right Hand)**

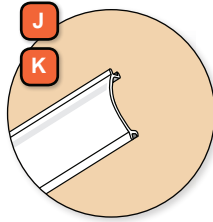

Tools needed:

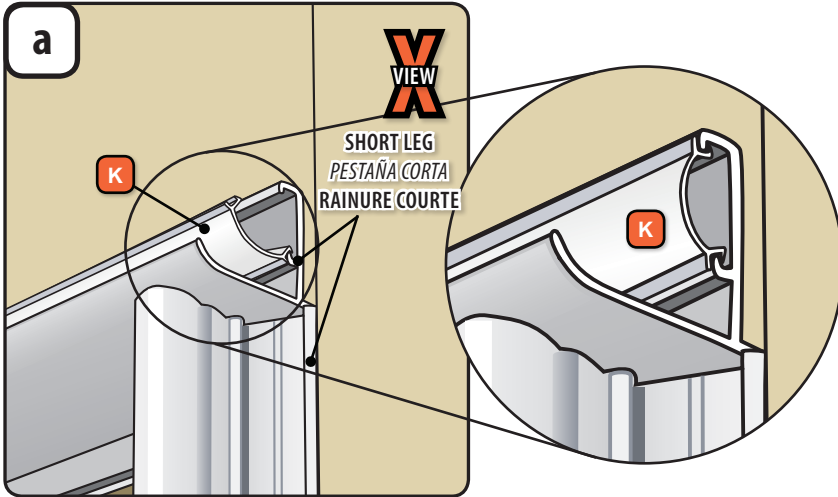

1. Lock leg of screw cover (K) into short leg of rain cap screw track. Press on other leg to snap it into long leg of track. Make sure screw cover snaps into screw track along the entire length of the rain cap.
2. Repeat this process with remaining side screw covers.
3. Using scissors, trim off any excess that may remain.

CLEANING INSTRUCTIONS

WINDOW GLASS – The glass may be cleaned with any household glass cleaner. Keep glass cleaners away from painted parts and brass/nickel components.

PLASTIC PARTS – Plastic door components may be cleaned using a mild soap and water mixture and by gently rubbing the affected area. Do not use harsh abrasives or any product that contains chlorine.

ALUMINUM PARTS – Aluminum parts on the door may be cleaned using a mild soap and water mixture and by gently rubbing the affected area. Mineral spirits may be used and will not harm the paint. This will remove many items such as glue residue. Do not use harsh abrasives or any product that contains chlorine.

LIMITED WARRANTIES

PRODUCT LIMITED WARRANTY

DOOR FRAME: EMCO Enterprises, Inc. (EMCO) warrants the door frame, hinges, and painted finish on EMCO® storm door products to be free from defects in manufacturing, materials, paint adhesion, or workmanship, under normal use, for ten (10) years or as long as the original consumer purchaser owns the home in which the door was initially installed, whichever is shorter.

COMPONENTS: EMCO warrants the non-glass and non-insect screen fabric components of EMCO® storm doors (including brass and nickel hardware finish and the mechanical functions of locksets, closers, windows and insect screens) to be free from defects in manufacturing, materials and workmanship for a period of one (1) year from the date of original retail purchase or for as long as the original consumer purchaser owns the home in which the door was initially installed, whichever is shorter. Kick panel retention within the frame is not covered under this warranty.

In the event a door frame, hinges, insulated glass or a component fails as a result of a defect in manufacturing, materials or workmanship within the limited warranty period specified above, and upon written proof of purchase, EMCO, at its option, will provide a replacement door frame, hinge, and/or components without charge – installation is not included. Such replacement or repair is warranted for the remainder of the original limited warranty period. Please locate the door serial number and written proof of purchase and contact EMCO Consumer Support at 1-800-933-3626.

“OOPS-PROOF” INSTALLATION LIMITED WARRANTY

EMCO Enterprises, Inc. (EMCO) warrants that any part lost or mis-cut during the original installation of your EMCO storm door will be repaired or replaced at no additional charge within ninety (90) days of the date of original purchase. This limited warranty will not apply if the part has been misused, abused or altered. Cutting parts not specified by the installation guide or mis-drilled parts are not included in this warranty.

In the event a part is lost or mis-cut within the limited warranty period, EMCO, at its option, will provide the appropriate replacement part – installation is not included. Please locate the door serial number and written proof of purchase and contact EMCO Consumer Support at 1-800-933-3626.

GENERAL LIMITED WARRANTY INFORMATION

The limited warranties set forth in this document are the only express warranties (whether written or oral) applicable to EMCO® storm doors, and no one is authorized to modify or expand these limited warranties. All warranty claims must be made during the applicable warranty periods.

ALL IMPLIED WARRANTIES INCLUDING MERCHANTABILITY AND FITNESS FOR A PARTICULAR PURPOSE ARE LIMITED TO THE APPLICABLE STATUTE OF LIMITATION, BUT IN NO CASE WILL THEY EXTEND BEYOND THE TERM OF THE LIMITED WARRANTIES SET FORTH ABOVE. EMCO EXCLUDES AND WILL NOT PAY FOR INCIDENTAL OR CONSEQUENTIAL DAMAGES, WHETHER ARISING OUT OF CONTRACT, TORT OR OTHERWISE, AND ITS LIABILITY WILL IN ALL INSTANCES BE LIMITED TO THE REPAIR OR REPLACEMENT OF THE DEFECTIVE PRODUCT.

Some states do not allow the exclusion of incidental and consequential damages, or limitation of the duration of an implied warranty, so the above limitations or exclusions may not apply to you. This limited warranty gives you specific legal rights, and you may also have other rights that may vary from state to state and in Canada.

What is NOT covered by this limited warranty: Damage caused by 1) improper installation, maintenance, or use 2) chemicals or airborne pollutants, such as salt or acid rain; 3) acts of God, including wind damage; 4) Products not manufactured by EMCO

EMCO Enterprises, Inc. is a wholly owned subsidiary of Andersen Corporation. EMCO manufactures Andersen® and EMCO® storm doors. EMCO supports the limited warranties covering Andersen® Storm and Screen Doors. “Andersen”, “EMCO” and all other marks where denoted are trademarks of Andersen Corporation. ©2013 Andersen Corporation. All rights reserved.

Reprinted and effective as of May, 2011.

On-line Parts and Knowledge Store

Andersen is committed to helping you find parts quickly and easily for your Andersen® or EMCO® storm door. Use the site below and your serial number to find many of the most-common replacement parts for your storm door.

This site also includes the Andersen Storm Door Learning Center. Whether you are trying to find other Andersen® or EMCO® products or you are looking for replacement part installation guides, or other care and maintenance topics and tips, this is a great place to start.

parts.andersenstormdoors.com