

***Master Flow[®] Direct Drive
Standard Whole House Fan
Installation Instructions***

Updated: 2003



***Quality You Can Trust...From North
America's Largest Roofing Manufacturer!™***

www.gaf.com



**Master Flow™ Direct Drive
Standard Whole House Fan Installation Instructions**

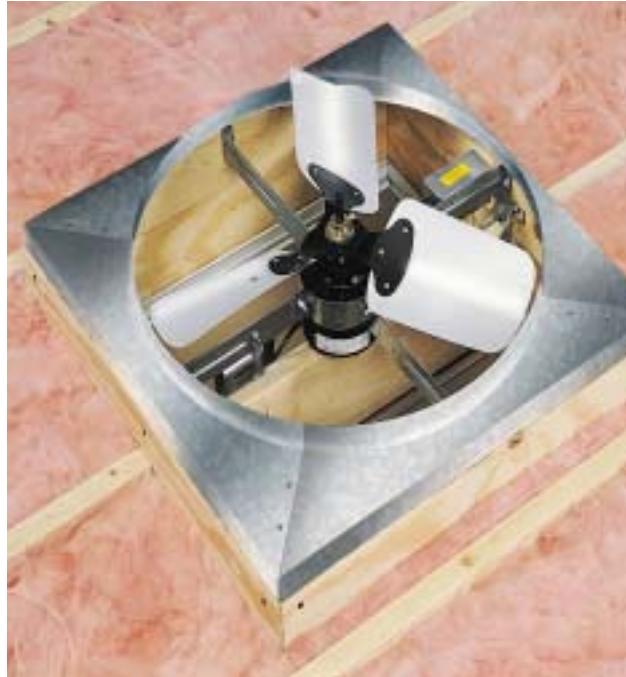

visit us at www.gaf.com

Quality You Can Trust Since 1886...from
North America's Largest Roofing And Ventilation Manufacturer

Master Flow Hdqts.: 877.GAF.COOL
(877.423.2665)

Eastern Sales Office: 732.297.0091
Central Sales Office: 815.372.9701
Southeast Sales Office: 813.248.6202

Southwest Sales Office: 214.637.1060
Western Sales Office: 909.360.4200
Canadian Sales Office: 800.555.1852

©2003 GAF Materials Corporation 1361 Alps Road • Wayne, NJ 07470



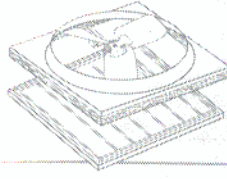

READ ALL INSTRUCTIONS FOR THE FAN AND THE SHUTTER BEFORE STARTING YOUR INSTALLATION.

For satisfactory performance and safety, your fan must be installed correctly. You must know how to use the tools and equipment required.

TOOLS NEEDED:

- 1/4" drill
- 1/4" and 1/8" drill bits
- Straight edge ruler (yardstick)
- Razor knife
- Flat head screwdriver
- Phillips head screwdriver
- Pencil or marker
- Sabre or keyhole saw
- Small nails or tacks
- 1/16" or adjustable wrench

IMPORTANT: AIR OUTLET OPENINGS FROM THE ATTIC ARE NECESSARY FOR PROPER OPERATION. A MINIMUM ATTIC EXHAUST OPENING OF 1440 SQUARE INCHES FOR THE WHF530 OR 1008 SQUARE INCHES FOR THE WHF524 IS REQUIRED FOR YOUR WHOLE HOUSE FAN. (See chart below)

Net Free Venting Area (NFVA) refers to the actual amount of open area of a vent.

DIRECT DRIVE WHOLE HOUSE FANS:

24" models need 1008 sq. in. of NFVA.

30" models need 1440 sq. in. of NFVA.

This exhaust ventilation can be accomplished by any combination of GAF/MASTERFLOW™ ventilation products.

Ridge Vents:

AR10 = 21 sq. in. NFVA per foot

SRR4 = 60 sq. in. NFVA per 4 ft. section

Cobra Ridge II® = 75 sq. in. NFVA per 4 ft section

Undereave Vents:

EA/EAC16X8 = 65 sq. in. NFVA.

EA/EAC16X6 = 45 sq. in. NFVA.

Soffit Vents:

LSV8 = 82 sq. in. NFVA per 8 ft. section

Cobra® Sof-Edge™ = 28 sq. in. NFVA per 8 ft. section

* NOTE: This is only a partial list of exhaust ventilation products offered by GAF/MASTERFLOW™.

CAUTIONS:

- 1** Always provide adequate intake ventilation with open doors and/or windows.
- 2** Do not operate wood stoves and fireplaces at the same time as your whole house fan.
- 3** Do not operate the fan in an attic where a gas or oil fired furnace or water heater is in use as the operation can interfere with the flue. Inadequate intake may hamper flue operation on oil or gas fired equipment.
- 4** Do not install in attics with less than 1000 square feet of area.

WARNING:

TO REDUCE THE RISK OF FIRE OR ELECTRIC SHOCK, DO NOT USE THIS FAN WITH ANY SOLID STATE SPEED CONTROL DEVICE.

All electrical wiring should be done in accordance with the National Electric Code and all local codes. This fan is intended for installation facing an unoccupied space only. These fans are intended for horizontal mounting only. Fan is intended for residential use only.

NOTE: Use this unit only in the manner intended by the manufacturer.

CAUTION: Automatically operated device. To reduce the risk of injury, disconnect from power before servicing.

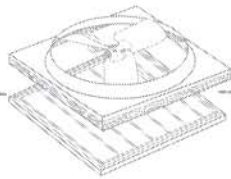

Read each step completely before beginning installation procedure.
Verify that all parts are present. If parts are missing call 1-800-211-9612

FIND THE BEST LOCATION TO INSTALL YOUR FAN

As you select a location, keep the following in mind:

- 1** The best place to install your whole house fan is in or near a central hallway (Figure 1).
- 2** You may be able to use the present attic exhaust openings to exhaust the hot air (See pg1 Net Free Venting Area).
- 3** Be sure to leave enough space around the fan. This will insure good air movement (Figure 2).

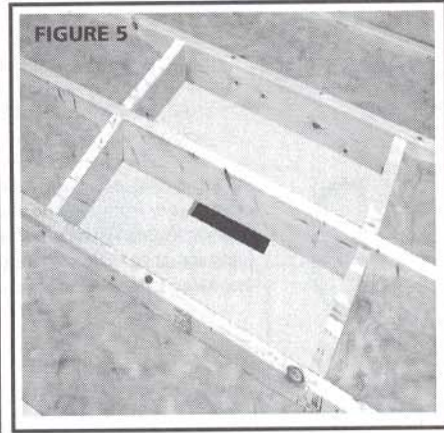
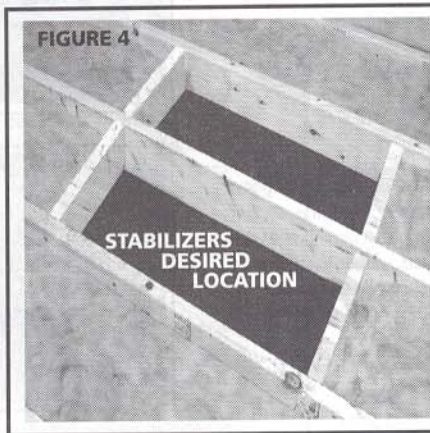
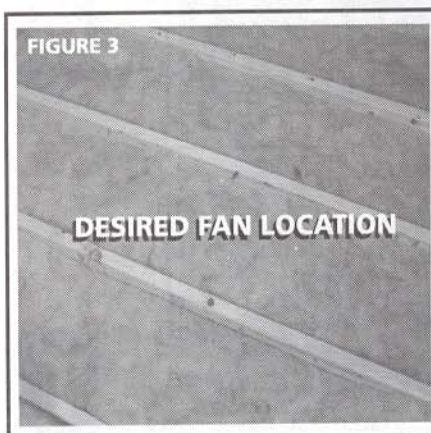
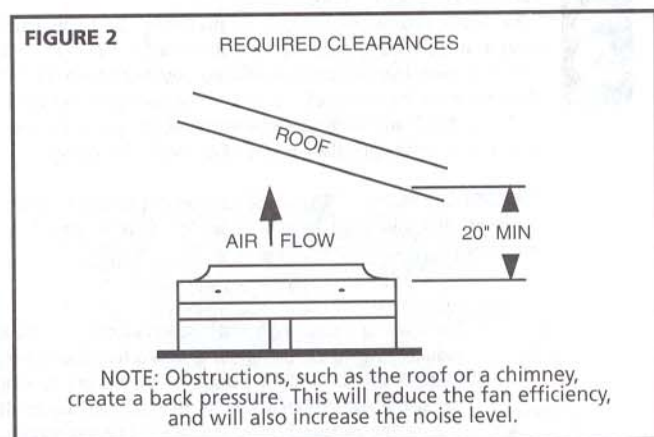
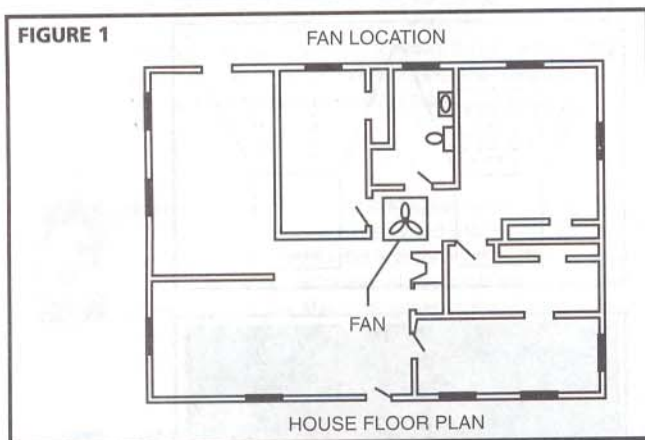

1

Locate desired position of whole house fan from hallway (or other alternative location) and drive a nail through the ceiling in the center of the location where the fan is to be placed.

From inside the attic, carefully remove insulation and find where the nail is located. Make sure attic floor area is free of electrical wiring and plumbing pipes (Figure 3). Check joist for stability (rocking). If joist has unusual amount of play, stabilize by bridging across to adjacent joists (Figure 4). Keep stabilizers at outside edge of desired fan location at least 36" apart. Cut out template alignment slots from sheet rock at selected joist. These cutouts should be approximately 2" wide and 12" long (Figure 5).

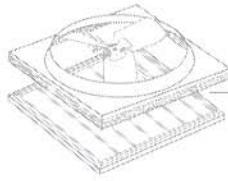

F R O M I N S I D E H A L L W A Y

2 After removing shutter and hardware from carton, cut template from carton along outside edge. Use straight edge (yardstick) and razor knife for clean cut. Cut and remove alignment slots on template. Align template along exposed joist. Tack template at corners along joist to keep in position. Scribe along outside perimeter of template using pencil or marker (Figure 6).



3 **FOR A "NO JOIST CUT" INSTALLATION:**
If the joists run across (perpendicular to) the hallway, the hallway must be at least 36" wide for a 30" fan and 30" wide for a 24" fan. If the joists run with (parallel to) the hallway, you must have 15 1/2" clearance from the center of the joist to the wall (or molding) for either size fan. If you meet the requirements above, you can proceed with your no joist cut installation. (STEP 4 on the following page).

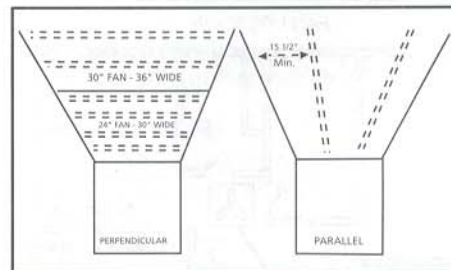

FOR JOIST CUT INSTALLATION: If joist location interferes with shutter operation, the joist must be removed. See Steps A thru D for instructions.

A The opening should begin at a joist and extend in width as required (Figure 7). The opening should be framed using joist sized lumber with the inside of the framed opening being the size required for the shutter used (Figure 8). Discard the plenum boards and saddle brackets supplied with this fan.

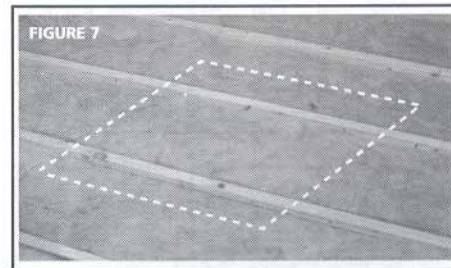

B Before cutting a joist in a finished ceiling, we suggest cutting and removing the sheet rock from the shutter opening (Figure 7), and then framing the opening between joists and at the side with joist sized lumber extending to and nailed to the adjacent joists as shown in (Figure 8).

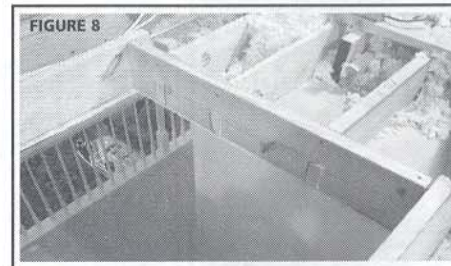

C Lift the fan through the opening into the attic. Build a platform around the top of the framed opening using at minimum 1" x 4" lumber nailed to the frame and joists (Figure 9). It must extend wide enough to support all edges of the fan frame creating an air seal and forming a duct from the living space to the fan, thus assuring that air is drawn only from the home below, maximizing effectiveness. Then the joist(s) across the opening may be cut flush with the edge of the opening.

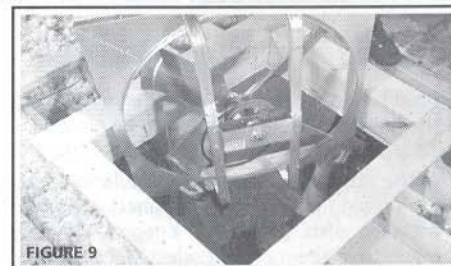
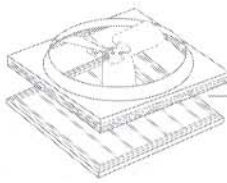

FIGURE 9
BELT DRIVE MODEL SHOWN



D Place fan on the platform centered over the opening. A good method of securing the fan in location is to drive nails part way into the platform beside the frame, two per side. Two inch "L" brackets provide a very secure fit to the platform as well. Proceed with wiring and shutter installation. (Step 5)

4 With hardware provided, mount saddle brackets (2) to inside of fan frame in pre-drilled holes (Figure 10). Loosen set screw and remove blade from motor shaft. Set aside so as not to be damaged. Cut out shutter opening marked on ceiling. Pass fan into attic through ceiling cut-out. Set fan on joist. Saddle brackets will center fan along joist.

NOTE: Fan must be mounted with pull chain next to joist in order to align with pull chain hole in shutter. From inside hallway, center fan over shutter cut-out. Drill 1/4" hole through joist using saddle bracket as drill guide. Drill lower hole on one bracket only. Secure through joist with bolt, lock washer and nut provided. Tighten securely. Follow same procedure at lower hole of other bracket. Make sure fan is sitting level on joist. Repeat procedure on other holes.

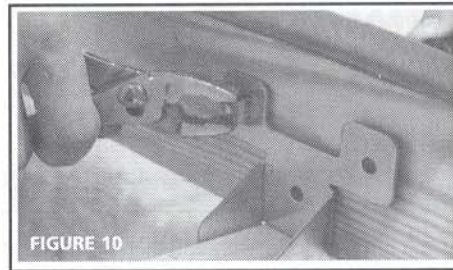

FIGURE 10

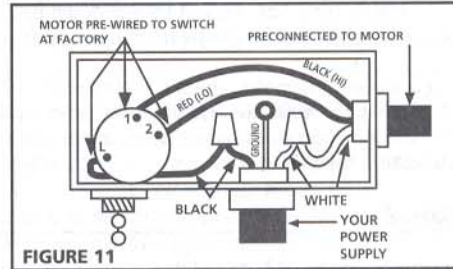

FIGURE 11

5 It is recommended that a qualified electrician be engaged to perform wiring of fan. Fan should be connected only to 120 volt circuit. Make sure circuit to be used for fan is disconnected at fuse or breaker box before proceeding. Following all applicable electrical codes, bring power supply to fan. Make connections as shown (Figure 11). Ground to screw provided in back of wiring box. Make sure all connections are secure, with no exposed copper conductor. Mount box cover.

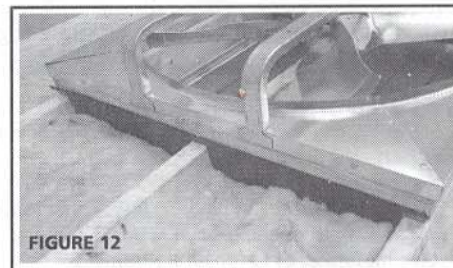

FIGURE 12

6 **FOR NO JOIST CUT ONLY:** Position plenum boards from top of ceiling to above joists, adjacent to fan, and nail in place (Figure 12). Plenum boards may be notched for incoming power supply. (Duct tape can be used to seal any large misalignments due to improper cutting or placement of boards. Apply from outside fan frame.)

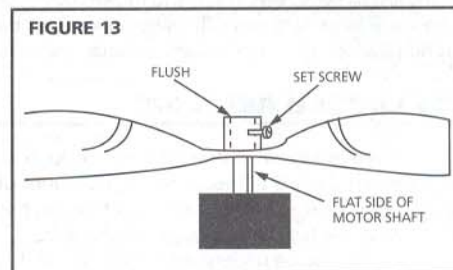

FIGURE 13

Replace fan blade on motor shaft with set screws in hub of blade facing flat side of motor shaft. For models 24M and 30M, the blade should be positioned on the shaft with the hub flush with the top of the shaft. Tighten fan blade set screws securely. This alignment gives proper placement of blade in venturi for maximum performance (Figure 13). Slowly rotate blade one full revolution by hand to ensure that it encounters no obstructions.

7 Using chain connector provided with the shutter, attach pull chain only to chain at pull switch. Assemble pull chain guide to hole in center vane of shutter as shown (Figure 14). Position shutter so pull chain to switch passes through chain guide in shutter. (Hole directly below switch-box on fan.) Mount shutter according to instructions included in shutter carton.

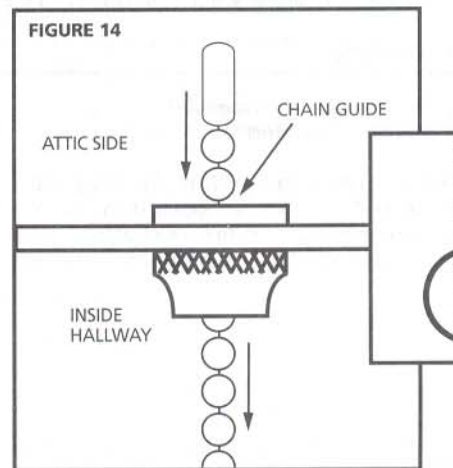

FIGURE 14

Pass pull chain through pull ball and cut chain to desired length. Attach chain connector to end of chain below pull ball. The large hole in pull ball will slide over and cover connector (Figure 15). Before applying power to fan circuit, open windows and interior doors to ensure proper air intake through rooms to be cooled. If you have a fireplace, be sure the flue damper is closed to prevent chimney dirt and soot from being brought into the house when fan is turned on. Apply power to fan circuit. Your MasterFlow™ Whole House Fan is now ready for use.

FIGURE 15

OPERATING INSTRUCTIONS:

Pull once -- High Speed Pull again -- Low Speed Pull Again -- Off

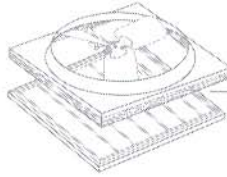

Q U E S T I O N & A N S W E R

MOTOR STOPPED

☹️ My unit ran for a little while and then the motor stopped. Now it doesn't run at all. Should I just send it back?

😊 First, if the motor is hot, allow it to cool down before trying to run the unit again. Direct drive motors will need to be replaced if they no longer run when power is applied, as the thermal overload has probably opened.

After replacing the motor, check these items before running the unit again:

- Check that you have the recommended amount of exhaust area in the attic. Too little exhaust area can overwork the motor causing it to overheat and shut down. SEE EXHAUST AREA, (page 1) for requirements.
- Check that the wiring is correct.

NOISY

☹️ My shutter rattles. What can I do?

😊 Check for correct fan blade clearance and sufficient exhaust area. Not enough exhaust area can cause backpressure, making shutters vibrate.

☹️ My unit is noisy. What can I do?

😊 All models - check for:

- Clearance above the fan blade at least equal to the diameter of the blade.
 - Enough exhaust opening. See EXHAUST AREA (page 1) for required exhaust areas.
 - Secure mounting of fan to house framing.
 - Tightness of set screws in fan and motor mount bolts.
- These are large fans and will make noise when they operate. Occasionally customers will object to the normal amount of noise which the fan makes. In these cases, after trying the steps above, they may need to return the fan.

NOT ENOUGH AIR FLOW

☹️ It doesn't move any air. It doesn't move enough air.

- 😊
- Be sure that there is the recommended amount of exhaust area in the attic. Air has to be able to exhaust out of the attic for the fan to draw air in through the house. See EXHAUST AREA (page 1) for square footage needed.
 - Check that the fan is operating on high speed.
 - The fan may also be undersized for the house. Try "zoning" the air flow by closing some of the windows in a portion of the house not being used and see if this improves air flow for the rest of the house.

VIBRATES

☹️ My unit vibrates. What can I do?

😊 All models - check for:

- Clearance above the fan blade at least equal to the diameter of the blade.
- Enough exhaust opening. See EXHAUST AREA (page 1) for required exhaust areas.
- Secure mounting of fan to house framing.
- Tightness of all set screws in fan and motor mount bolts. Also, all set screws in bearings and pulleys if applicable.