

BEFORE YOU BEGIN



Scan for easy 3D instructions
Download the BILT app before you begin



ASSEMBLY REQUIRES AT LEAST 2 ADULTS, 3 ADULTS ARE RECOMMENDED. PLEASE FOLLOW THE STEP BY STEP GUIDE AND ENJOY YOUR HOVERING WITCH!

IF ANY PART IS MISSING OR BROKEN, DO NOT ATTEMPT TO ASSEMBLE THE PRODUCT AND CONTACT SVI CUSTOMER SERVICE FROM 8:30AM TO 5:30PM PST AT 1-855-428-3921, EMAIL CUSTOMERSERVICE@SVIUS.COM, OR CALL HOME ACCENTS HOLIDAY CUSTOMER SERVICE FROM MON-FRI 8:00AM TO 7:00PM AND SAT 9:00 AM TO 6:00 PM EST AT 1-855-HDHOLIDAY (1-855-434-6543).

EASY ASSEMBLY AND OPERATION INSTRUCTIONS

22SV23269 Hovering Witch

READ AND SAVE THESE INSTRUCTIONS FOR FUTURE REFERENCE

IMPORTANT TIPS:

- Ensure that the item's adapter is plugged in at the Function Control Box and in the wall.
- Ensure that the switch on the function control box is on the desired setting.
- If not functioning properly (ex: eyes & body don't light up), ensure that cables are connected to their corresponding cable as shown in the instruction sheet.
- Be sure nothing is blocking movement or caught in moving parts.
- Ensure that the floor or surface that the item sits on is flat and level.

- Ensure that the volume is not all the way down.
- Be sure nothing is blocking the sensor.
- If the item still does not work, contact SVI Customer Service from 8:30am to 5:30pm PST at 1-855-428-3921, email customerservice@svius.com, or call Home Accents Holiday Customer Service from Mon-Fri 8:00am to 7:00pm and Sat 9:00 am To 6:00 pm EST at 1-855-HDHOLIDAY (1-855-434-6543).

PARTS LIST

- A. Right Base Half x 1
 - B. Left Base Half x 1
 - C. Lower Support Pole x 1
 - D. Broom Bristles x 1
 - E. Support Pole x 1
 - F. Broom Stick 1 x 1
 - G. Broom Stick 2 x 1
 - H. Broom Stick 3 x 1
 - I. Upper Support Pole x 1
 - J. Broom Stick Cap x 1
 - K. Right Arm x 1
 - L. Right Hand x 1
 - M. Costume x 1
 - N. Upper Torso Frame x 1
 - O. Lower Torso Frame x 1
 - P. Head x 1
 - Q. Hip Hoop x 1
 - R. Leg Frames x 2
 - S. Foam Tubes x 2
 - T. Left Arm x 1
 - U. Left Hand x 1
 - V. Cape x 1
 - W. Hat x 1
 - X. Broom Stick 4 x 1
 - Y. Base Extensions x 4
 - Z. Adapter Receiver x 1
 - Z1. Elastic Band x 1
 - Z2. Stakes x 4
 - Z3. Adapter * x 1
- * Power Adapter Spec
Input: 120VAC 50/60Hz
Output: 5.9V 2.0A



NOTE: Throughout the instructions, Right and Left are from the character's point of view.

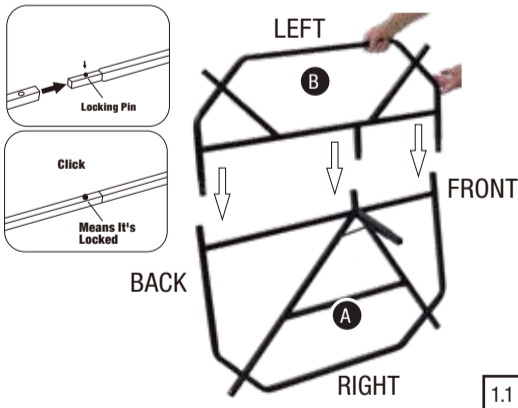

NOTE: Remove wing nut from the (A) Right Base Half before attaching the (C) Lower Support Pole. Remove clips from the struts of the (C) Lower Support Pole before attaching to the (A) Right Base Half.

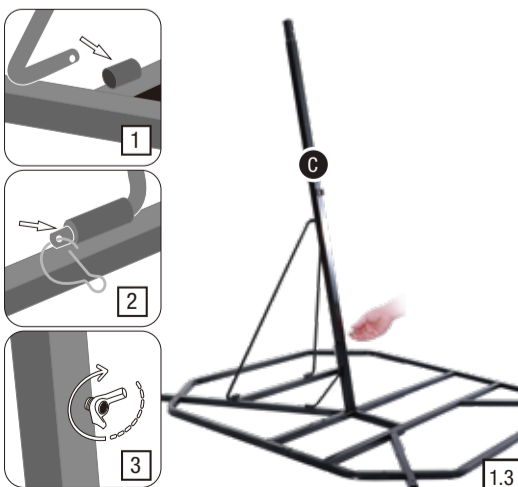
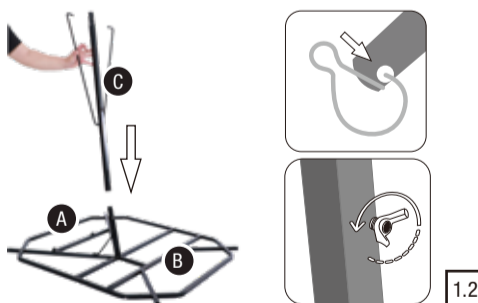

NOTE: Place the block of the (Z) Adapter Receiver in the (D) Broom Bristles with the remaining cable emerging from the top.

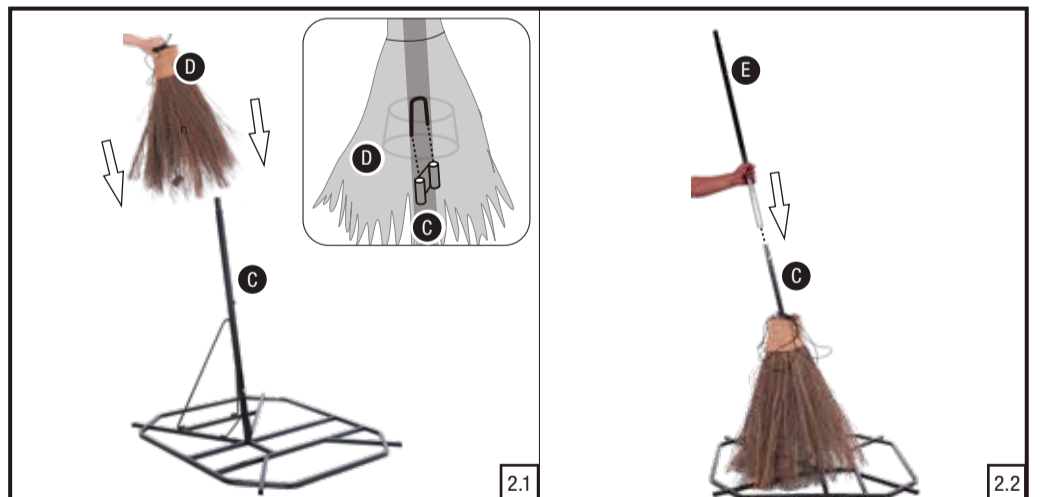

NOTE: Guide the (Z) Adapter Receiver cable through the (D) Broom Bristles and (F) Broom Stick 1 before sliding (F) Broom Stick 1 onto the (E) Support Pole.

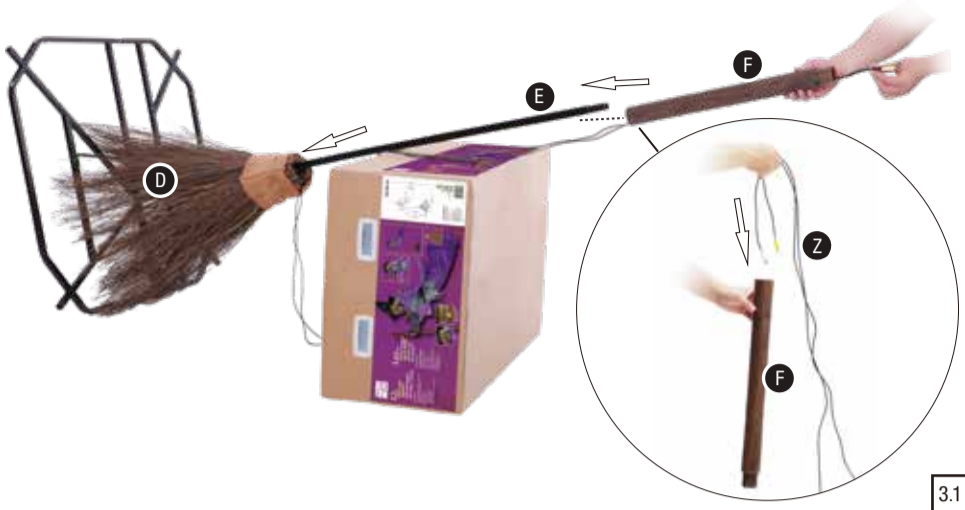

3.1

NOTE: Guide the (Z) Adapter Receiver cable through the (G, H) Broom Sticks before sliding them onto the (E) Support Pole.



3.2

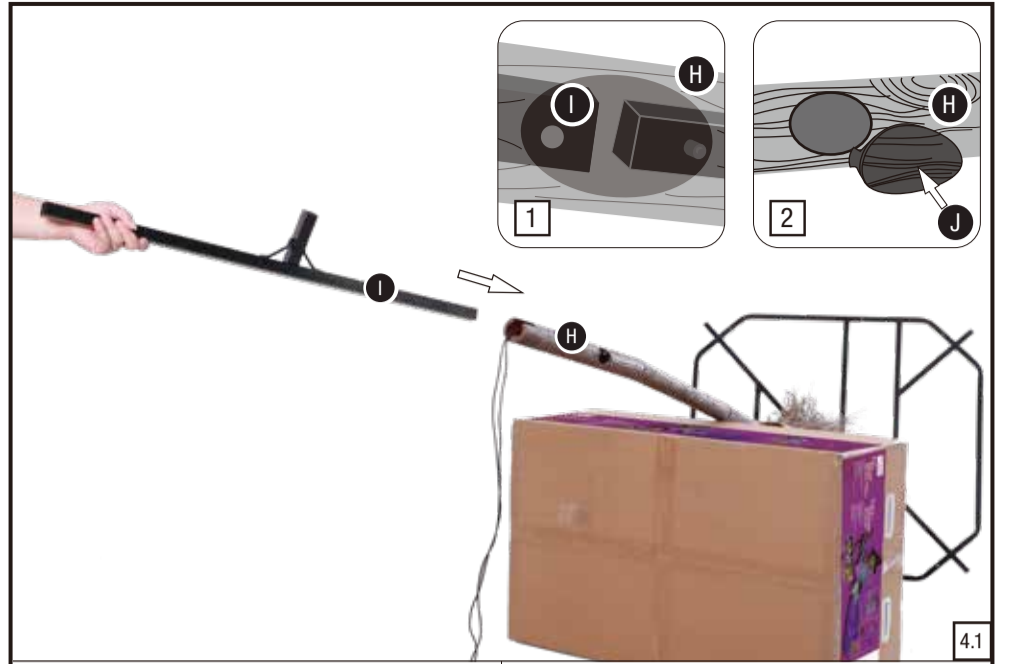

4.1

NOTE: Connect the cable from the inside of the (L) Right Hand to the corresponding cable available from the (K) Right Arm.

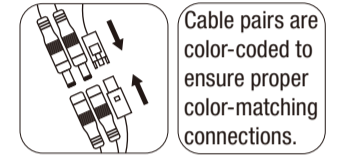

Cable pairs are color-coded to ensure proper color-matching connections.

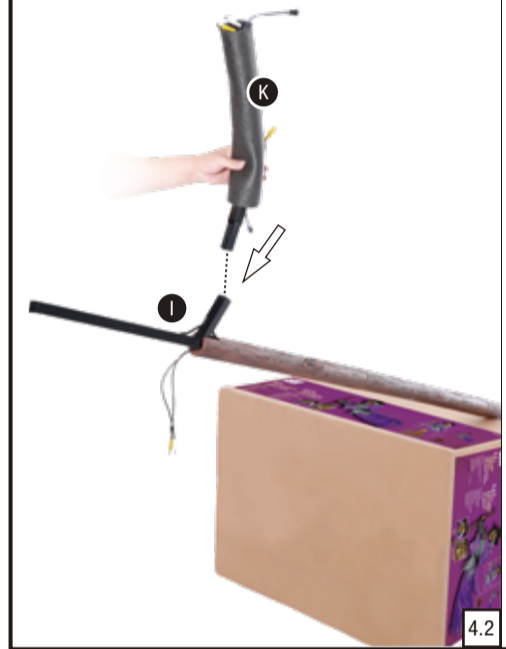

4.3

NOTE: Slide the right sleeve of the (M) Costume over the (K) Right Arm.

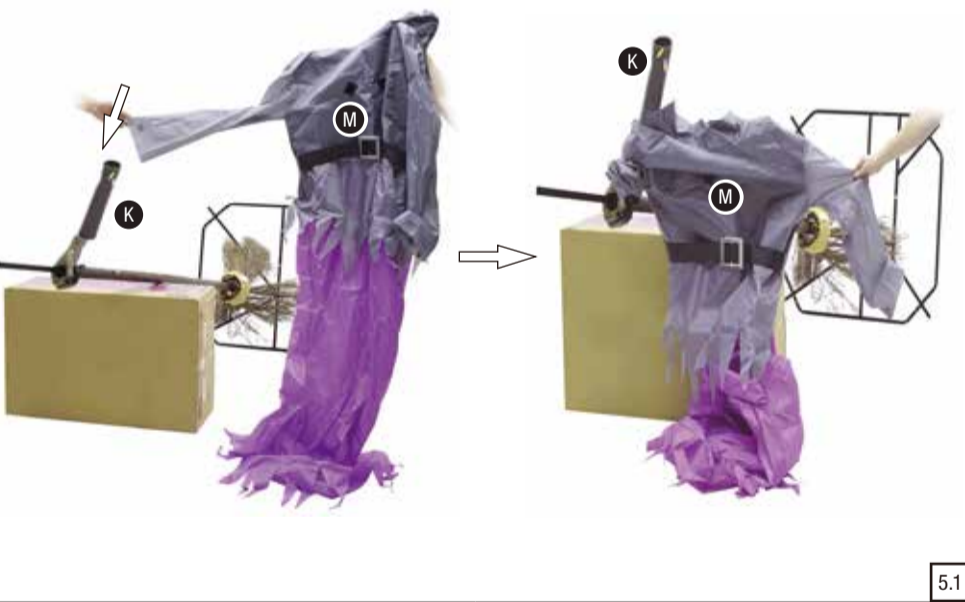

5.1

NOTE: Guide (M) Costume over the (N) Upper Torso Frame.

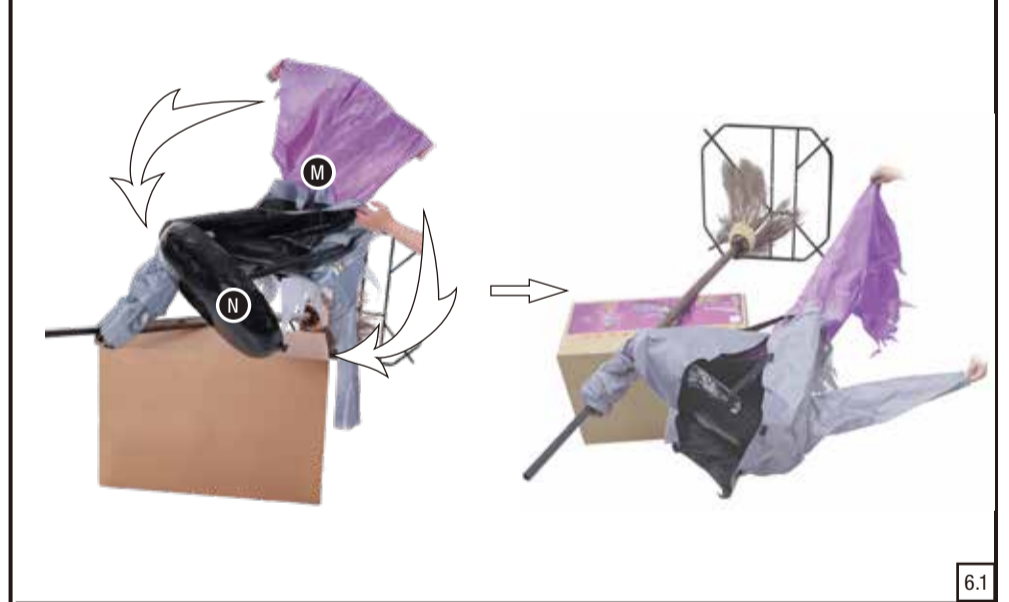

6.1

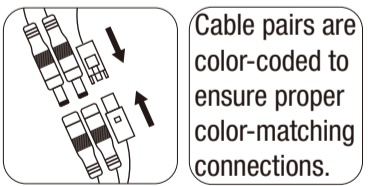

Cable pairs are color-coded to ensure proper color-matching connections.



5.2



6.2

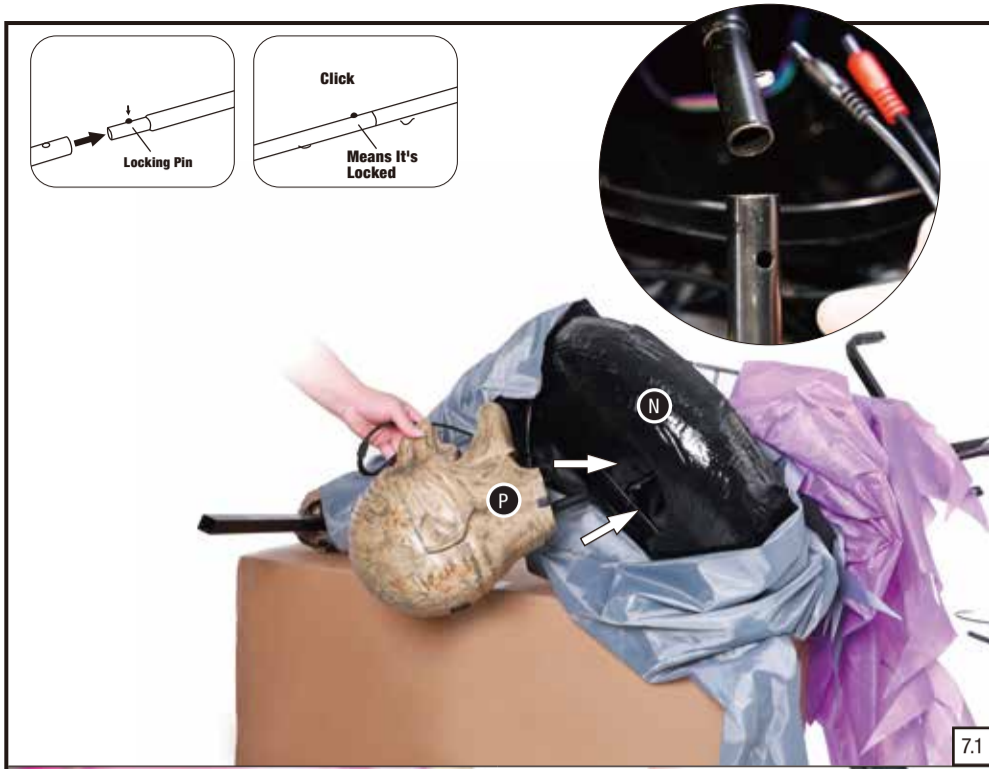

7.1

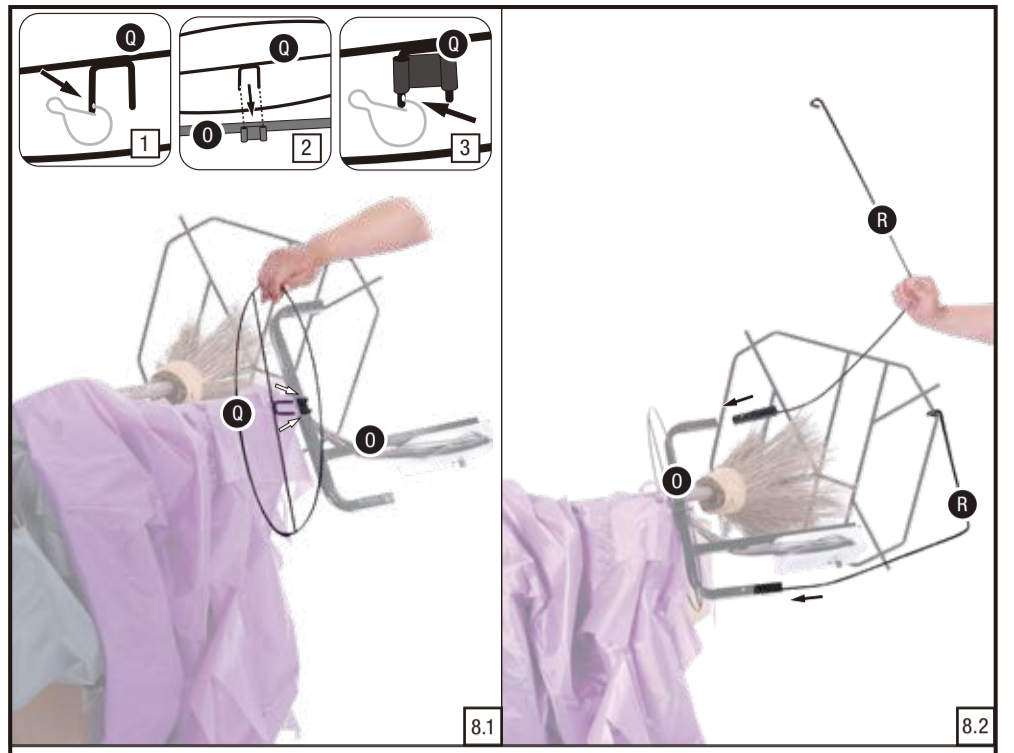

8.1

8.2

NOTE: If you cannot find the corresponding Sensor cable, it is attached to the inner-front surface of the (M) Costume. If the Sensor is not in the (M) Costume, search the box the Witch came in for the Sensor and attached cable.

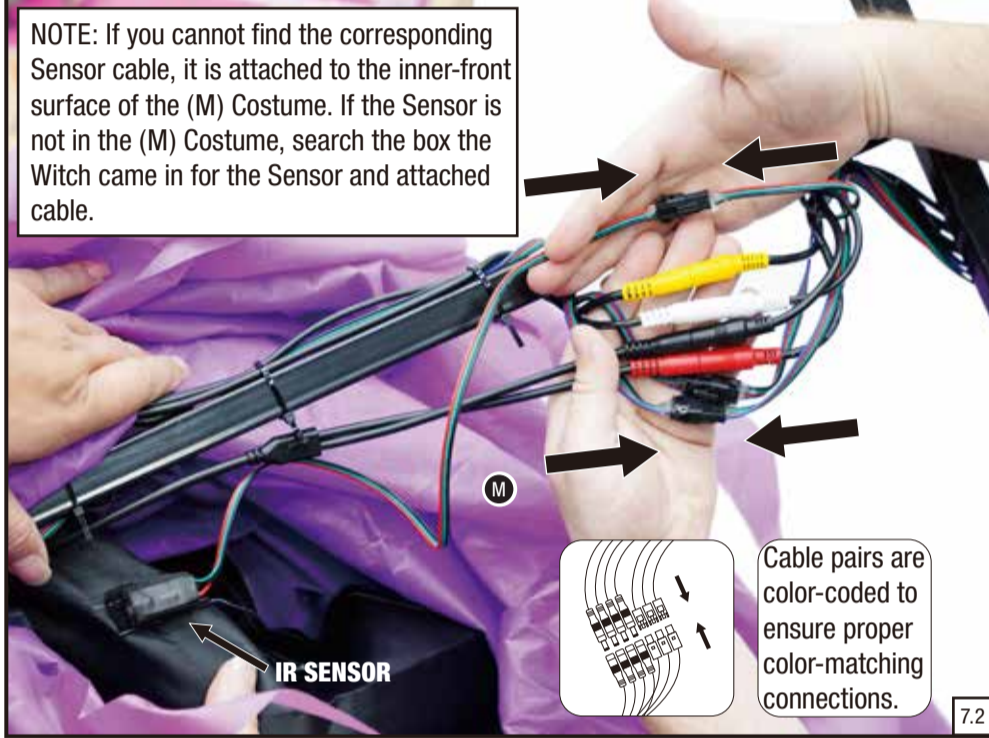

7.2



8.3

NOTE: Secure the elastics from within the (M) Costume over the (S) Foam Tubes.

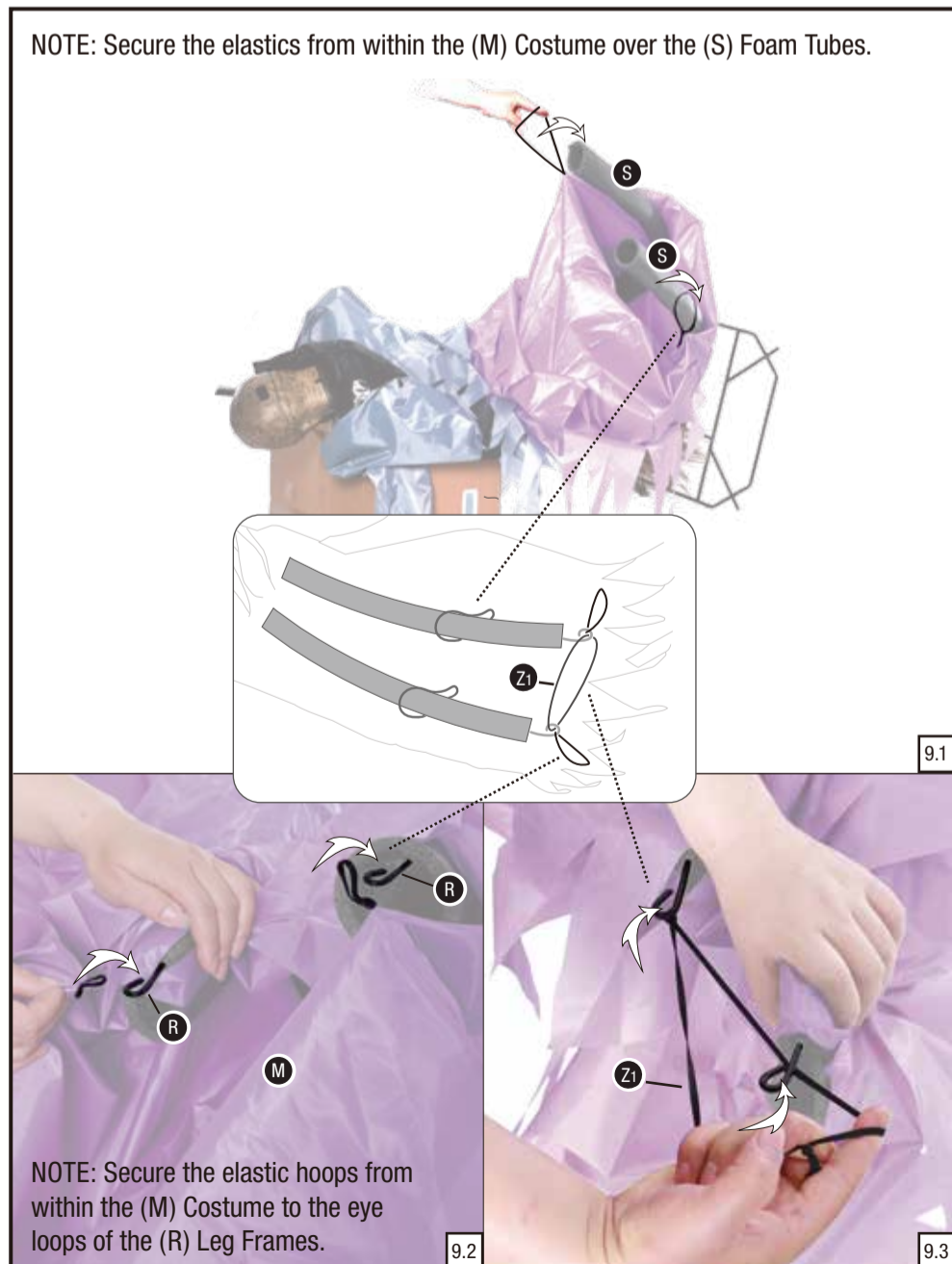

9.1

NOTE: Secure the elastic hoops from within the (M) Costume to the eye loops of the (R) Leg Frames.

9.2

9.3

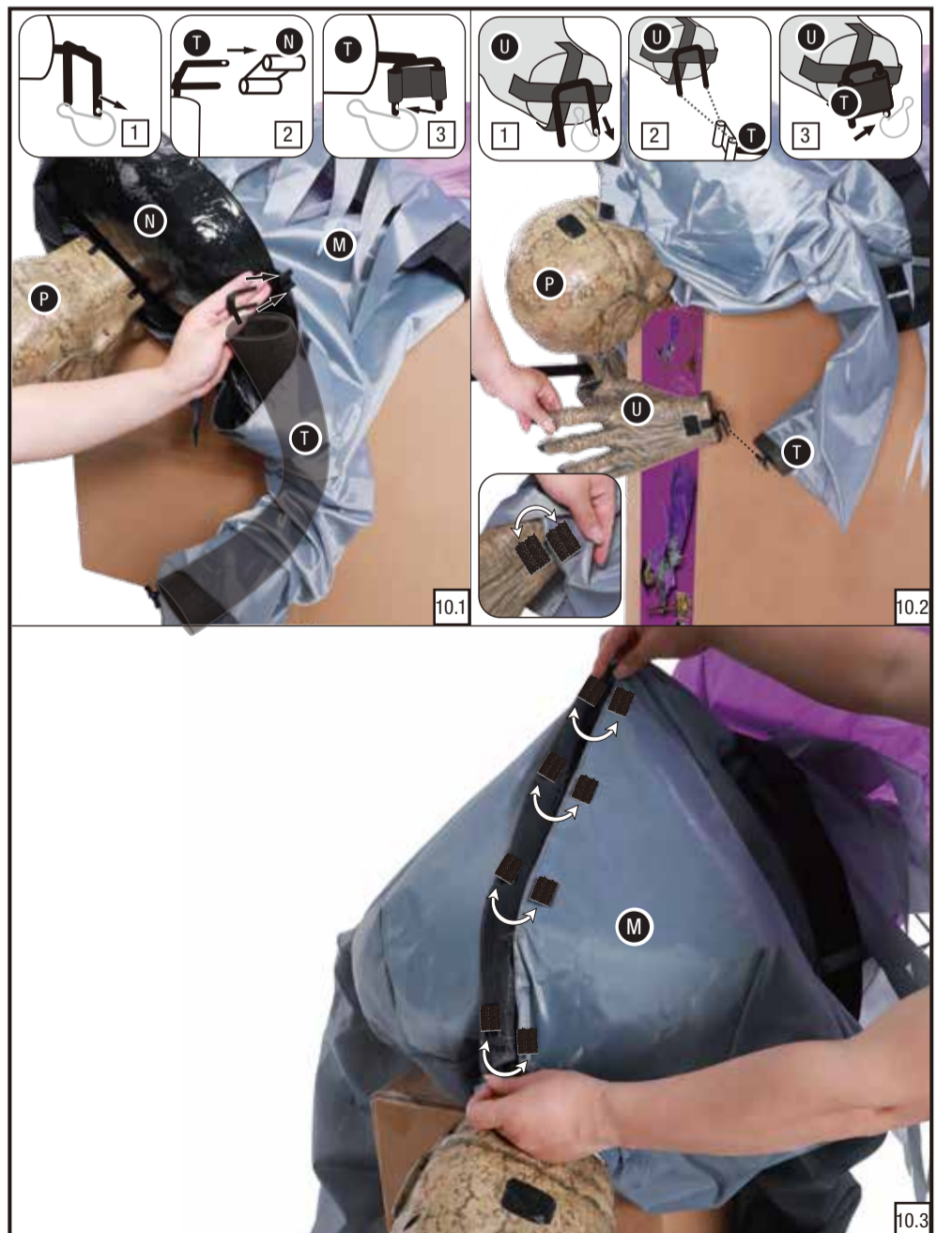

10.1

10.2

10.3

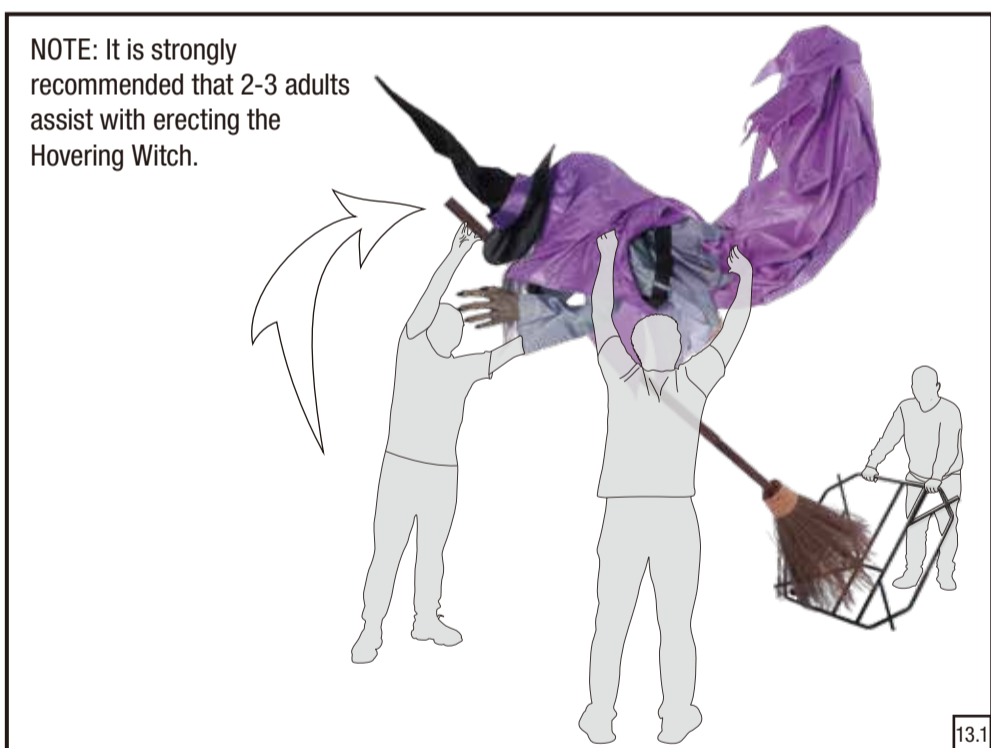

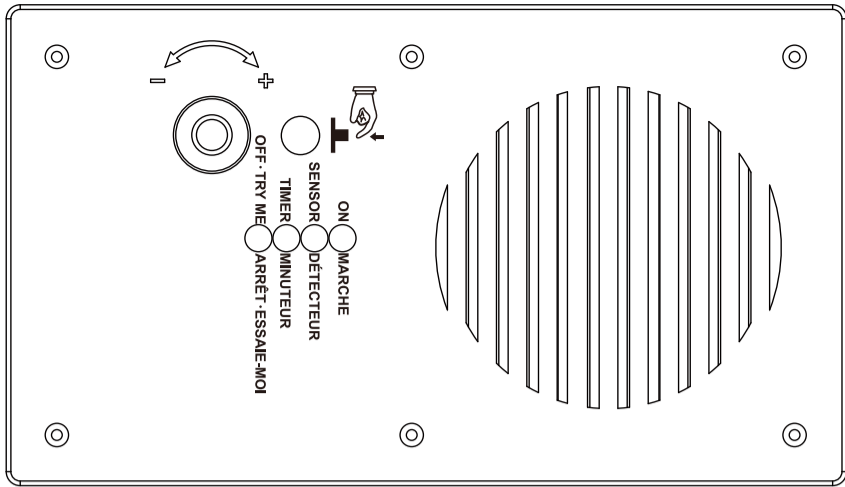

OPERATION INSTRUCTIONS:

The Hovering Witch is powered by an adapter. Plug in the power adapter into a standard power outlet. To turn on the Hovering Witch, press the button on the Function Control Box. Press the button again to switch to the Sensor setting. Press the button a third time to switch to the Timer Setting. Press the button a fourth time to turn the item Off.

The item is activated by pressing the button on the Function Control Box and has the following settings:

ON/MARCHE	This switch mode will activate the lights and the LCD eyes of the item. This switch mode does not have any animation.
SENSOR /DÉTECTEUR	This switch mode will activate lights, LCD eyes, sound, and animation when the Infra-red (IR) sensor is activated and will operate for 1 audio-cycle with each activation. The Infra-red (IR) sensor has a range of up to 2 m/6.5 ft. and will activate when someone comes within an 80-degree angle from left-to-right, as well as from above and below.
TIMER /MINUTEUR	This setting will operate the same as sensor mode within a 6HR On/18 HR Off period.
OFF • TRY ME /ARRÊT • ESSAIE-MOI	This setting will deactivate the lights, LCD eyes, sound, and animation of the item. This mode also allows the item to be activated if triggered by using a Step Here Try Me Activation Pad (Not Included). The item will operate for one audio cycle with each Try Me activation.
	Raise or lower the volume using the volume control turn dial, turn all the way down to turn the volume off.

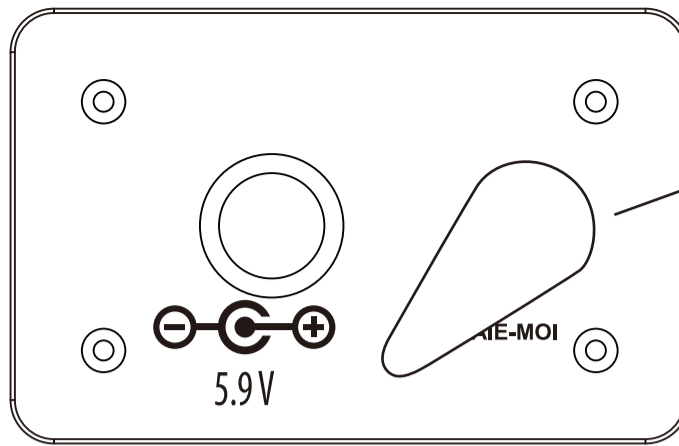

NOTE: Make sure the waterproof cap is covering the Try Me receiver at all times when not in use.

WARNING:

- Lay product down before a storm or strong winds.
- Don't climb or pull on product.
- Don't add to or modify product.
- Assemble and place the product on level surfaces only.
- Don't push or tilt product.

WARNING

This item is not a toy and should be used for decoration only. This item contains small parts that can be a choking hazard. Keep all plastic and wire parts away from children.

1. Please use the adapter supplied by manufacturer.
2. Please assemble item according to instructions. Connect all wires according to matching color.
3. Children should be supervised by adults. Item should not be grabbed, as it becomes a tipping hazard. Keep flammables away from the adapter, as it heats up during operation.

Please view all instructions carefully before assembling. Save this instruction sheet for future reference.

CARE AND STORAGE INSTRUCTIONS

When not in use, store this product in its original packing. Keep away from heat and moisture.

This device complies with Part 15 of the FCC Rules. Operation is subject to the following two conditions: (1) This device may not cause harmful interference, and (2) this device must accept any interference received, including interference that may cause undesired operation.

CAUTION: Changes or modifications not expressly approved by the party responsible for compliance could void the user's authority to operate the equipment.

NOTE: This equipment has been tested and found to comply with the limits for a Class B digital device, pursuant to Part 15 of the FCC Rules. These limits are designed to provide reasonable protection against harmful interference in a residential installation. This equipment generates, uses, and can radiate radio frequency energy and, if not installed and used in accordance with the instructions, may cause harmful interference to radio communications. However, there is no guarantee that interference will not occur in a particular installation. If this equipment does cause harmful interference to radio or television reception, which can be determined by turning the equipment off and on, the user is encouraged to try to correct the interference by one or more of the following measures: Reorient or relocate the receiving antenna, Increase the separation between the equipment and receiver. Connect the equipment into an outlet on a circuit different from that to which the receiver is connected. Consult the dealer or experienced radio/TV technician for help. CAN ICES-003(B)/NMB-003(B)

1 WE SUGGEST AT LEAST TWO ADULTS FOR ASSEMBLY	2 NO MOVING AFTER FULLY ASSEMBLED	3 LEVEL AREA ONLY	7 USE ADAPTOR	8 CONTACT US IF EYES, MOUTH, LIGHTS DON'T WORK CONTACT US 1-855-434-6543
4 DO NOT PUSH OR TILT	5 DO NOT CLIMB OR PULL ON	6 DO NOT ADD TO OR MODIFY	9 DO NOT DISPLAY DURING STRONG WINDS	10 BROOM BRISTLES FLAMMABLE. KEEP AWAY FROM HEAT, SPARKS, AND FLAMES. KEEP OUT OF THE REACH OF CHILDREN.
11 CONTACT US 1-855-434-6543				