

# 6363-8371 Gunmetal Covered Closet ©2017 Whitmor, Inc.

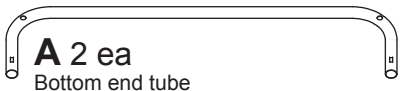

**A** 2 ea  
Bottom end tube

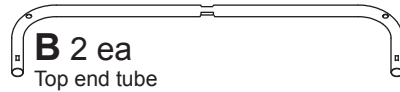

**B** 2 ea  
Top end tube

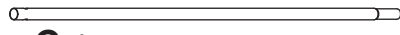

**C** 4 ea  
Female horizontal tube

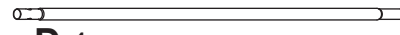

**D** 4 ea  
Male horizontal tube

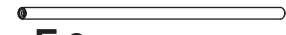

**E** 2 ea  
Horizontal support tube

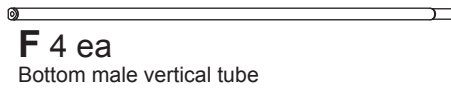

**F** 4 ea  
Bottom male vertical tube



**G** 4 ea  
Top female vertical tube

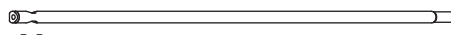

**H** 2 ea  
Bottom male center vertical tube

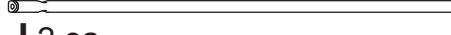

**I** 2 ea  
Top female center vertical tube

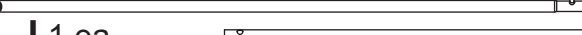

**J** 1 ea  
Male hanging tube

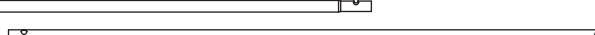

**K** 1 ea  
Female hanging tube



**L** 6 ea  
Floor glide

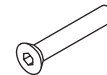

**M** 16 ea  
Countersunk hex screw

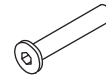

**N** 2 ea  
Flat head hex screw



**O** 2 ea  
Hanging tube hook



**P** 1 ea  
Cover

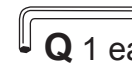

**Q** 1 ea  
Hex wrench

This product's intended use is for storing clothes.

**Assembly Time:** Less than 1 hour.

**Tools Needed:** No additional tools required.

**STEP 1.** Assemble male and female horizontal tubes (C&D) then assemble two bottom end tubes (A) by pressing together. Install four floor glides (L) and four bottom male vertical tubes (F) using four hex screws (M). Install two more floor glides (L) and two bottom male center vertical tubes (H) using two hex screws (M). Tighten all hex screws with hex wrench (Q).

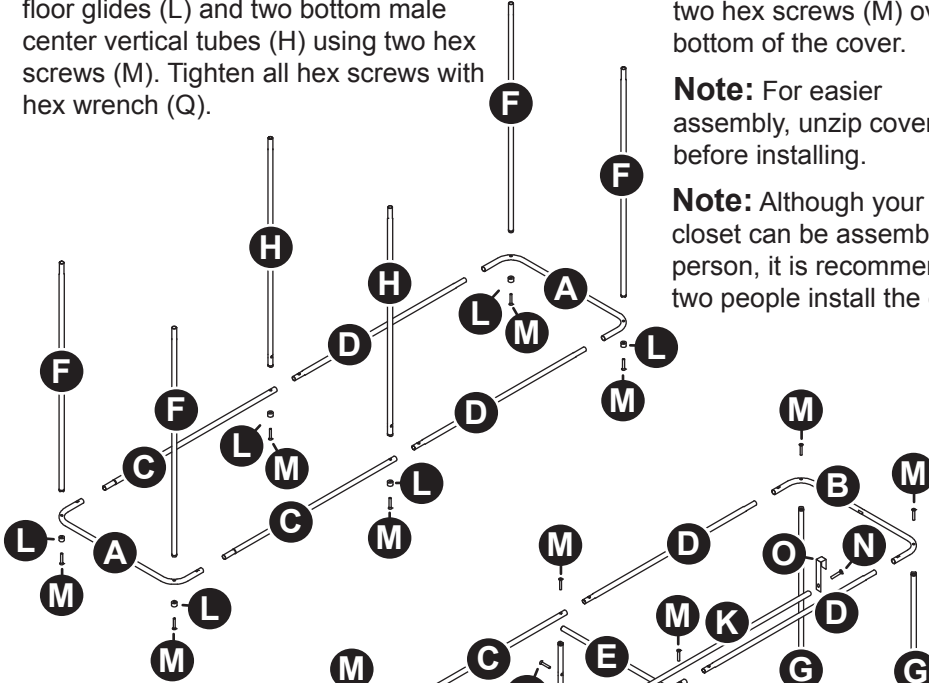

**STEP 2.** Unzip the cover (P) front and carefully fit holes in bottom of cover over the bottom male vertical tubes (F&H). Slide the cover down and carefully lay the cover back. Install one horizontal support tube (E) with two hex screws (M) over the bottom of the cover.

**Note:** For easier assembly, unzip cover before installing.

**Note:** Although your clothes closet can be assembled by one person, it is recommended that two people install the cover.

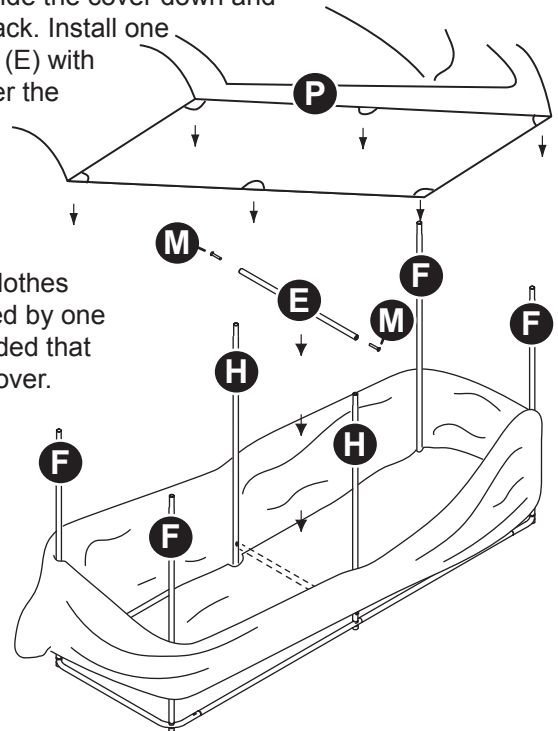

**STEP 3.** Install four top female vertical tubes (G) and two top female center vertical tubes (I) onto bottom male vertical tubes (F&H). Assemble two top end tubes (B) to male and female horizontal tubes (C&D) by pressing together. Install this top section to the tubes (G&I) using six hex screws (M). Install one horizontal support tube (E) with two hex screws (M). Install the hanging tubes (J&K) to hanging tube hooks (O) using two flat head hex screws (N). Hang the hanging tube hooks (O) over the top end tubes (B). Tighten all hex screws with hex wrench (Q).

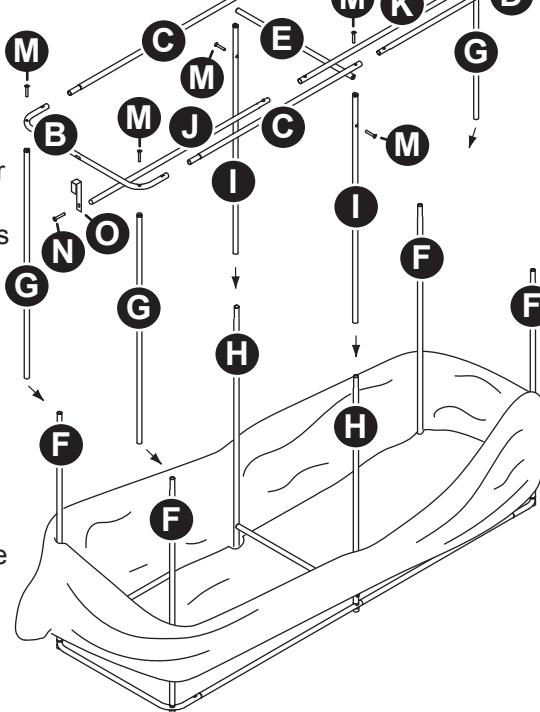

**STEP 4.** Lift the cover (P) up over the top of the frame, carefully fitting the corners of the cover over the top corners of the frame. Slide the bottom of the cover downwards evenly to the base of the frame.

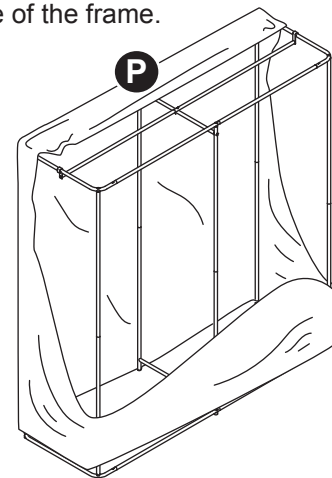

**STEP 5.** Zip up the cover front and the assembly is complete.

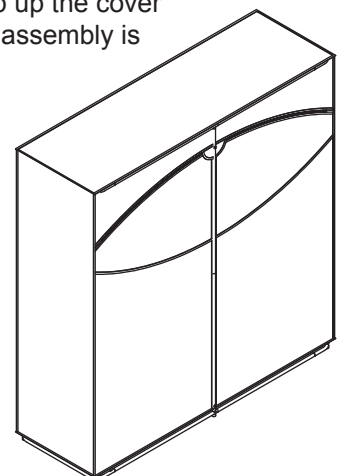

| Part | Reference |
|------|-----------|
| A    | F9339     |
| B    | F9338     |
| C    | F9343     |
| D    | F9342     |
| E    | F9348     |
| F    | F9341     |
| G    | F9340     |
| H    | F9345     |
| I    | F9344     |

| Part | Reference |
|------|-----------|
| J    | F9346     |
| K    | F9347     |
| L    | F9350     |
| M    | F9349     |
| N    | F9399     |
| O    | F9400     |
| P    | F9351     |
| Q    | F9401     |



8680 Swinnea Road • Suite 103 • Southaven, MS • 38671

**NEED HELP?** For help with assembly, or if you are missing a part, please call Whitmor's Consumer Care Team, 1-888-944-8667 between 8 a.m. and 4:30 p.m. (Central Standard Time) Monday through Friday. Or email: [help@whitmor.com](mailto:help@whitmor.com). Visit us online at [www.whitmor.com](http://www.whitmor.com)