

Item Number: A03518

WARNING (To reduce the risk of fire, electric shock, or injury to persons):

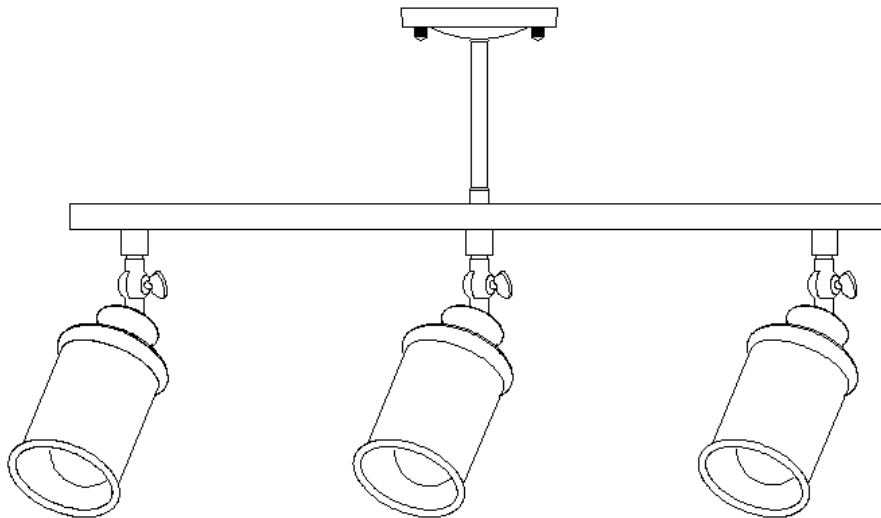



1. We suggest installation by a **licensed electrician**.
2. Please read the instruction carefully and save it as you may need it at later time.
3. Before you start, **NEVER** attempt any work without shutting off the electricity until the work is done. A). Go to the main fuse, or circuit breaker, box in your home. Place the main power switch in the “**OFF**” position. B). Place the wall switch in the “**OFF**” position.
4. Mounting surface should be clean, dry, flat, strong enough and 1/4” larger than the canopy on all side. Any gaps between the mounting surface and canopy exceeding 3/16” should be corrected as required.
5. Make sure that the ceiling or wall can stand the weight of the lamp before fixture.
6. Make sure the voltage you are using is **120V**. The maximum wattage is **60W** per bulb.
7. Keep the lamp away from acidic and basic objects in case of damaging the surface of the lamp.
8. When replacing bulb, you should turn off or unplug the lamp and you must wait until it is cool as bulbs get hot quickly.
9. The safety instructions appearing in this manual are not meant to cover all possible conditions that may occur. It must be understood that common sense, caution and care must be used with any electrical products.

IMAGE FOR FINISHED PRODUCT:

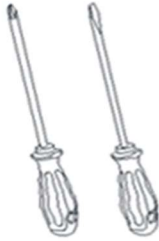

TOOLS REQUIRED (NOT INCLUDED):

Before doing assembly and installation please prepare the needed tools as below picture

				
Ladder	Phillips head, flat blade screwdriver	Electrical tape	Pliers	Wire cutter/Stripper

PARTS TYPE & QTY INCLUDING:

- (A) Mounting plate (1)
- (B) Green ground screw (1)
- (E) Hex nut (1)
- (F) Serrated washer (1)
- (G) Flat washer (1)
- (H) Canopy (1)
- (I) Ball nut (2)
- (J) Stem (1)
- (K) Square tube (1)

ACCESSORIES & QTY ENCLOSED:

- (C) Plastic Wire Connector (3)
- (D) Mounting screw (2)
- (N) Wrench (1)

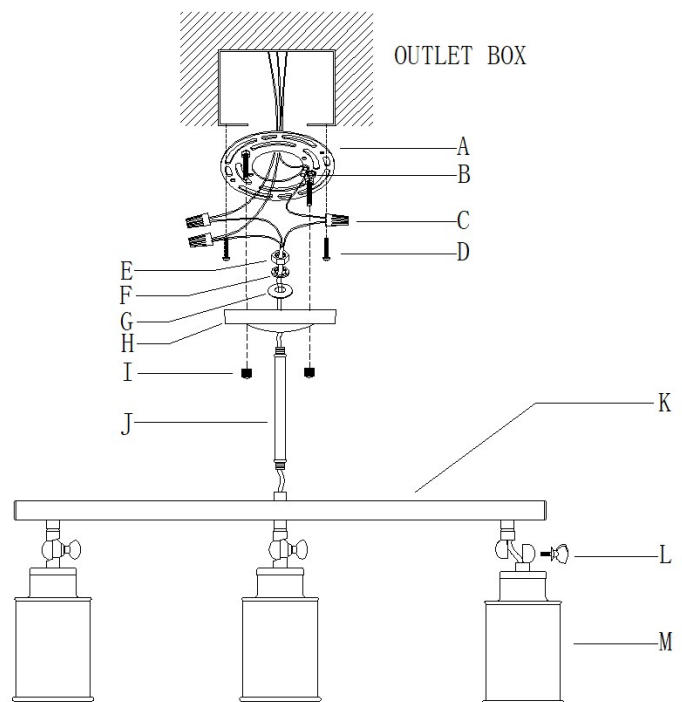
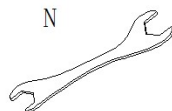

ASSEMBLY & INSTALLATION INSTRUCTIONS:

1. Carefully remove the fixture from the carton and check that all parts and accessories are included as shown in the above illustration.
2. **Turn off power**
Before you start to make installation, NEVER attempt any work without shutting off the electricity until the work is done. A). Go to the main fuse, or circuit breaker, box in your home. Place the main power switch in the "OFF" position. B). Place the wall switch in the "OFF" position.
3. Unscrew the ball nuts from canopy (H), then gently remove the mounting plate (A) from canopy (H).

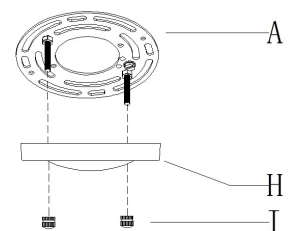

4. Unscrew the stud (L) from the joint then carefully lay the wires into the cave of joint and adjust the metal shade (M) until the holes in joints of square tube (K) and metal shade (M) are aligned, put joints together and secure with stud (L).

Slip stem (J) over the wires onto square tube (K). Then thread the stem (J) onto square tube (K) until snug.

Slip the canopy (H), flat washer (G) and serrated washer (F) over the wires to the top end of stem (J), secure with hex nut (E) serrated washer (F) and hex nut (E).

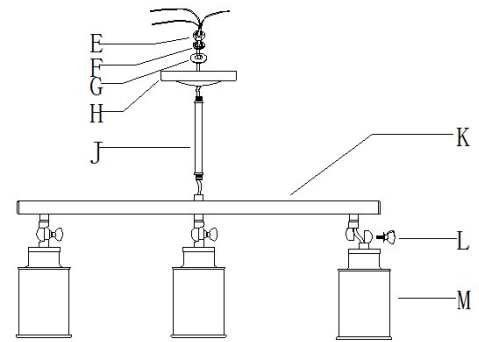

5. Carefully pass wires through the mounting plate (A) Secure mounting plate (A) to outlet box with outlet box screws (D).

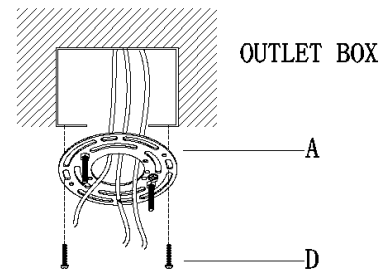

6. Make wire connections

Connect wires as below wires connecting shown. **TAKE NOTE OF YOUR COLOR OF FIXTURE ,NEVER CONNECT WIRES TO GROUND WIRES**

Connect ground wire according to below chart

Connect wires according to below chart

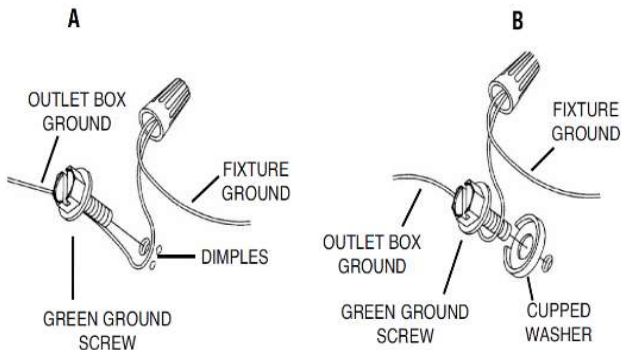

Connect Black or Red Supply Wire to:	Connect White Supply Wire to:
Black	White
*Parallel cord (round & smooth)	*Parallel cord (square & ridged)
Clear, Brown, Gold or Black without tracer	Clear, Brown, Gold or Black with tracer
Insulated wire (other than green) with copper conductor	Insulated wire (other than green) with silver conductor

*Note: When parallel wires (SPT I & SPT II) are used. The neutral wire is square shaped or ridged and the other wire will be round in shape or smooth (see illus.)

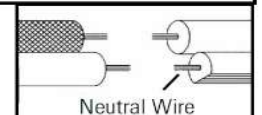

Twist plastic wire connector until wires are tightly joined together, wrap each connector with approved electrical tape. Be sure that no wire strands are exposed and then carefully tuck all wires into the outlet box.

7. Position the canopy (E) over the outlet box. Align the holes in the canopy (E) with the mounting screws, then attach the canopy (E) using the previously removed ball nuts (F). Hand tighten until snug.

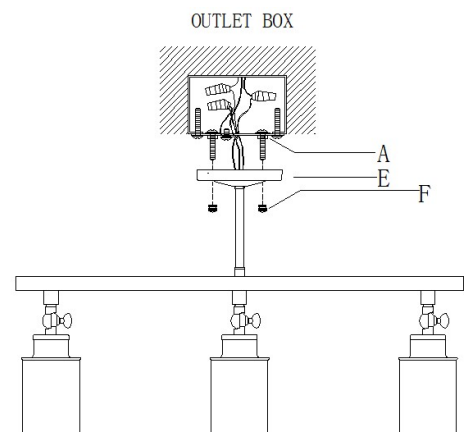

8. Loosen the stud (L) on the joints to adjust the angle of metal shade (M) front to back, once desired position of metal shade (I) is achieved, tighten the stud (L).
Install bulbs (Not included. Please do not exceed the maximum capacity recommended on the socket.)

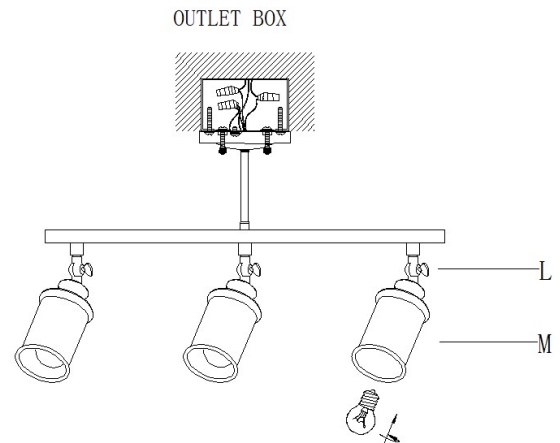

9. Check everything already is installed properly, then you could turn on the light. Enjoy !

CLEANING

To clean, wipe fixture with a soft cloth. Do not use abrasive materials such as scouring pads or powders, steel wool or abrasive paper.

ORDERING PARTS

Keep this sheet for future reference, and in case you need to order replacement parts. All parts for this fixture can be ordered from place of purchase. Be sure to use exact wording from illustration when ordering parts.