

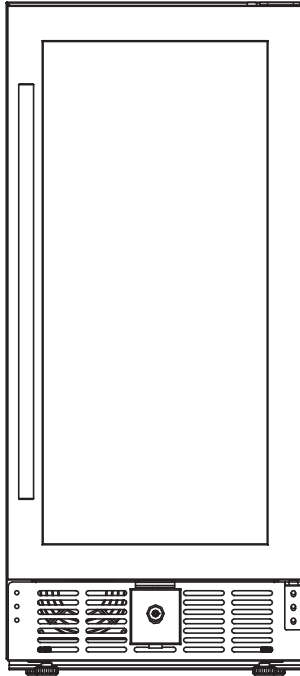

## **Undercounter 15" Beverage Cooler**



*Instruction Manual*

*Model: KM-BIR3C-GD*

**Thank you for purchasing our product!**

**Before returning to retailer, if you are having trouble with your unit, for assembly assistance, missing or damaged parts.**

**Please contact customer service Phone: 718-576-6342**

**Email: [support@koolmore.com](mailto:support@koolmore.com)**

**We are here to help.**

**Thank you!**

# TABLE OF CONTENTS

---

Product Features.....	2
Before Use.....	2
Energy Saving Tips.....	2
Important Safety Instructions.....	2
Included Parts.....	5
Specifications.....	6
How To Operate	
Storing Wine, Bottles, or Cans.....	6
Starting and Running the Unit.....	7
Button Panel Operation.....	7
How To Clean.....	7
How To Install.....	8
Care and Maintenance.....	9
Handle Installation Guide.....	10
Troubleshooting Guide	
What To Do.....	11
Limited Service Warranty .....	12

# PRODUCT FEATURES

---

1. Transparent glass door, luxurious looking, elegant design, easy operation.
2. Complete with attractive black color.
3. Low noise, high energy efficiency, updated quick cooling system.
4. Wire rack shelves, easy sanitation, storage convenience.
5. Touch-button control panel for operation.

## BEFORE FIRST USE

---

- Before connecting the appliance to the power supply, let the unit stand upright for 4 hours, which will reduce the possibility of the cooling system malfunctioning due to improper handling.
- Clean your unit thoroughly before putting into use. (See "How to Clean")
- Use the parts diagram on page 4 to insure proper positioning of internal components.

## TIPS FOR ENERGY SAVINGS

---

- Keep the unit doors closed as much as possible, particularly in warm / humid conditions.
- Maintain adequate ventilation around the back and sides of the unit.
- Allow warm wine bottle to cool to room temperature before placing in the unit.
- Do not obstruct the front hot air outlet frame.

## IMPORTANT SAFETY INSTRUCTIONS

---

**Before you use your refrigerator, basic safety precaution must be followed to reduce the risk of fire, electrical shock, and/or injury to person or property. Before you use your refrigerator, please read this owner's manual carefully and observe the following safety tips.**

Use this appliance only for its intended purpose as described in this owner's manual.

**-WARNING:** This appliance is intended to be used in household and similar applications such as

- staff kitchen areas in shops, offices and other working environments;
- farm houses and by clients in hotels, motels and other residential type environments;
- bed and breakfast type environments;
- catering and similar non-retail applications.
- The appliance must be correctly installed and connected to the power supply in accordance with the installation instructions before it is used.. (See: "HOW TO INSTALL").
- The main power supply must be properly grounded.
- This refrigerator must be positioned so that the plug is accessible. Never unplug you unit often by pulling on the power cord. Always grasp the plug firmly and pull straight out from the outlet.
- Do not use an extension cord as this can negatively affect the performance of the unit. If you must use an extension cord, use 18AWG minimum size and rated no less than 1875 watts.
- When transporting the refrigerator, keep the unit in the upright position. Do not tilt the appliance beyond 45° or place the unit in upside down position. Do not tip over.
- Do not touch the cooled surfaces while the appliance operates, especially not with wet hands,

because skin may stick to the cold surfaces.

- It is recommended that the refrigerator is positioned away from any combustible sources such as gas, petrol, alcohol, lacquer and banana oil, etc. The aforementioned objects should not be stored in the refrigerator under any circumstances.
- If the unit fails to cool properly, dispose of spoiled food as needed.
- Unplug your unit before cleaning or before making any repairs. **NOTE:** *If for any reason this product requires service, we strongly recommend that a certified technician perform the service. Repairs made by non-qualified personnel will void the warranty.*
- Do not defrost the appliance with other electric devices (hair dryer etc.) and never scrape the ice or frost layer with sharp tools. Warning: Do not damage the refrigerant circuit.
- The rating plate is inside the appliance or outside on the rear or side wall.
- This appliance is not intended for use by persons (including children) with reduced physical, sensory or mental capabilities, or lack of experience and knowledge, unless they have been given supervision or instruction concerning use of the appliance by a person responsible for their safety. Children should be supervised to ensure that they do not play with the appliance.
- Do not run cord over carpeting or other heat insulators. Do not cover the cord. Keep cord away from traffic areas, and do not submerge in water. If the supply cord is damaged, it must be replaced by the manufacturer or its service agent or a similarly qualified person in order to avoid a hazard. Repair or replace immediately all electric service cords that have become frayed or otherwise damaged. Do not use a cord that shows cracks or abrasion damage along its length, the plug or the connector end.
- **WARNING:** Keep ventilation openings, in the appliance enclosure or in the built-in structure, clear of obstruction.
- **WARNING:** Do not use mechanical device or other means to accelerate the defrosting process, other than those recommended by the manufacturer.
- **WARNING:** Do not damage the refrigerant circuit.
- **WARNING:** Do not use electrical appliances inside the food storage compartments of the appliance, unless they are of the type recommended by the manufacturer.
- Do not operate your refrigerator in the presence of explosive fumes.
- **WARNING--**Do not use the flame or catch the fire near the unit.
- Please dispose of the appliance according to local regulations as the appliance contains flammable gas and refrigerant.
- Follow local regulations regarding disposal of the appliance due to flammable refrigerant and gas. All refrigeration products contain refrigerants, which under the guidelines of federal law must be removed before disposal. It is the consumer's responsibility to comply with federal and local regulations when disposing of this product.



## **Safety instruction for refrigerant**

- DANGER-Risk of Fire or Explosion. FLAMMABLE REFRIGERANT Used. Do Not Use Mechanical Device To Defrost Refrigerator. Do Not Puncture Refrigerant Tubing
- DANGER-Risk of Fire or Explosion. FLAMMABLE REFRIGERANT Used. To Be Repaired Only By Trained Service Personnel. Do Not Puncture Refrigerant Tubing.
- CAUTION – Risk Of Fire Or Explosion. FLAMMABLE REFRIGERANT Used. Consult Repair Manual/Owner's Guide Before Attempting To Service This Product. All Safety Precautions Must be Followed.
- CAUTION--Risk of Fire or Explosion. Dispose Of Property In Accordance With Federal Or Local Regulations. Flammable Refrigerant Used.
- CAUTION – Risk Of Fire Or Explosion Due To Puncture Of Refrigerant Tubing; Follow Handling Instructions Carefully. FLAMMABLE REFRIGERANT Used.

# INCLUDED PARTS

The following diagram is also applicable to the wine cooler with a left-opening door.

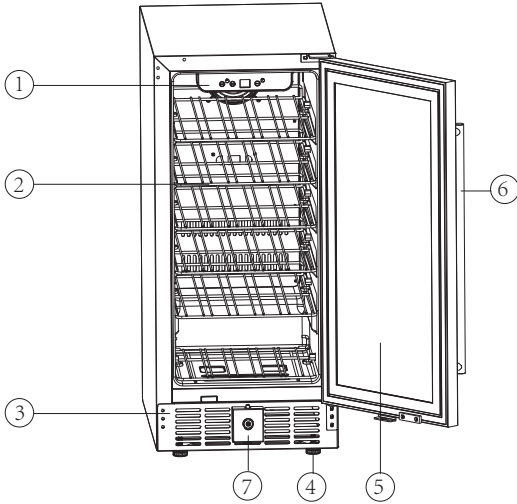

(1) Operation Panel:



- (2) Removable Wine Bottle or Can Shelf
- (3) Hot Air Outlet Frame
- (4) Height Adjustable Feet
- (5) Glass Door
- (6) Door Handle (Assembly Required )
- (7) Lock

# SPECIFICATIONS

Product Description	Wine cooler, Beverage center		
Model No.	KM-BIR3C-GD		
Capacity	82 L/2.9 Cu.Ft.		
Electrical Rating	115V~/60Hz/0.9 A		
Refrigerant	R600a, 0.67 Oz/19 g		
Unit Dimensions With Feet (Inches)	Width	Depth	Height
	15.0" ( 380mm )	22.5"(572mm)	33.8 "(860mm)
Net Weight (Lbs)	64.00Lbs		

## HOW TO OPERATE

### Storing Wine, Bottles, & Cans

- Wines should be laid on the shelves in sealed containers to avoid leakage.
- Do not overload.
- Do not open the door unnecessarily or leave the door ajar.
- Do not cover the shelf with any material such as aluminium foil as this will impede air circulation within the cabinet

Do not store explosive substances such as aerosol cans with a flammable propellant in this appliance.

Please place the wine bottles in reference to following figure: (for maximum storage)

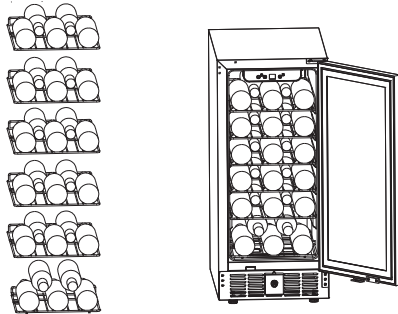

For canned beverage or drink, please see the following figure: (for maximum storage)

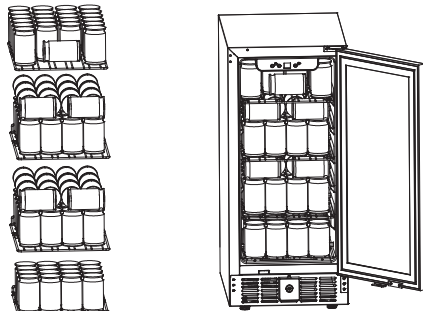

## Starting and Running the unit

**Important:** If the unit is brought in from outside in the winter season, give it a few hours to warm up to room temperature before plugging it in.

After transportation and moving the unit, please wait for a least 4 hours before plugging in and operating the unit.

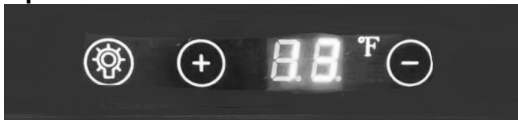

1. Remove the packaging material.
2. Clean the unit thoroughly. Wipe the outside with a soft dry cloth, the interior with a clean moist cloth.
3. Connect the power cord to a standard wall outlet. Once powered, you will hear a beep which is normal. The display on the control panel will revert to current internal temperature.
4. Do not put wines or beverages into the wine cooler within two hours after first powering on.

## Operation Button Panel



There are three buttons and a temperature display window on the control panel. These let you operate you unit and reach your desired running temperature.

### Temperature adjustment

Press two buttons "  " & "  " to adjust the set temperature to your desired value. Each press will change the temperature 1 Fahrenheit degree.

Setting Range: 36-61 Fahrenheit. The default setting is 39 Fahrenheit.

### Interior Light Control

The unit has built in with the LED light in the cooling compartment. When you open the glass door, the LED light will activate on. Closing the door will shut off the LED light. Additionally, the LED light is controlled by this button "  " on the control panel. Press this button, the LED light will change to half brightness, then after the

glass door is closed, the LED light will be still on. If you press the "  " button again, the LED light will recover to default max brightness. It will shut off when the glass door is closed. For maximum energy efficiency, leave the light off when not viewing your collection.

**Note:** Wait 3-5 minutes before restarting if you unplug the refrigerator. The unit may fail to operate properly if restarted too quickly.

## HOW TO CLEAN

**IMPORTANT:** Do not clean your unit with flammable fluids. The fumes can create a fire hazard or explosion.

**WARNING:** Before maintenance or clean to the unit, be sure to unplug the unit first.

DO NOT pour water onto or let the whole unit be submerged in water - this will ruin the

inside electrical parts.

**Cleaners:** Never use harsh, abrasive cleaners, heavy-duty cleaners, or solvents on any surface.

**Exterior:** Wipe with damp, sudsy cloth, rinse and dry. For stubborn stains and for periodic waxing, use silicon wax.

**Refrigeration Section:** Wash shelves and other removable parts in warm sudsy water, rinse and dry. Wash interior with baking soda solution (3 tablespoons to 1 liter of water) or warm sudsy water, rinse and dry.

**Magnetic Door Seals:** Wash with warm sudsy water.

## HOW TO INSTALL

**This appliance can either stand alone or be built in. The front grill must be not obstructed.**

- Install the unit in a convenient location away from extreme heat and cold. This unit should be far away from the heating source, such as stoves, heaters, or radiators, and from direct sunlight. Allow sufficient clearance between the unit and sidewall so the door will open without obstruction.
- Place the unit on a level surface that will be strong enough to support the unit when it is fully loaded. Not recommended for carpeting or other soft / uneven surfaces. To level your fridge, adjust the front feet located at the bottom of the unit.
- For under-counter built-in installation, please following the following diagram, and leave the enough space for the unit.

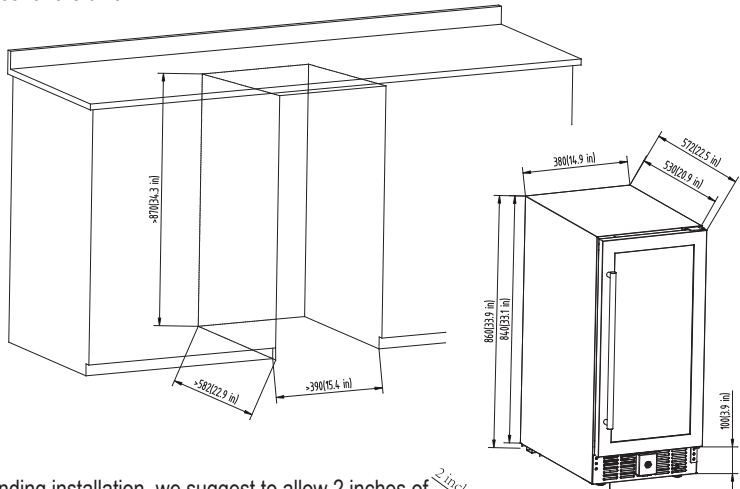

- For free standing installation, we suggest to allow 2 inches of space between the unit's side, rear, and the wall. In addition, sufficient clearance (160°) should be maintained to allow the glass door to open properly and completely.

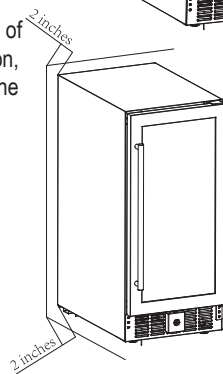

- The appliance must be correctly connected to the power supply, 115V/60Hz, and grounded.

**The unit is not designed to be installed in an outside area such as a garage or a porch. Ambient temperatures of below 50°F or above 90°F will hinder the performance of the appliance.**

## CARE AND MAINTENANCE

---

- ▶ The unit should be cleaned on a regular basis. (See: "HOW TO CLEAN")
- ▶ It is necessary to have an adequate ventilation space around the unit in order to attain proper performance, dissipation of heat, maintain efficiency, and low power consumption. Clearance of minimum 2 inches should be maintained at the rear and sides of the unit. **And especially do not obstruct the front hot air outlet frame.** (See: "HOW TO INSTALL")
- ▶ Do not modify the power cord under any circumstance to allow the unit to be plugged into a non-grounded outlet. To avoid heat damage to the power cord, please ensure that it does not come in proximity or in direct contact with the compressor of the unit.
- ▶ Please avoid installing the unit in a location where the appliance will come in contact with water or moisture to minimize rusting of metal parts.
- ▶ The unit should not be installed near any heat source or in a location where it will come in direct contact with the sunlight.
- ▶ The components, if need to be replaced, should be replaced with like components, and should be replaced by the manufacturer or its service agent or a similarly qualified person in order to avoid a hazard and to minimize the risk of possible ignition and also to decrease the cooling performance due to incorrect parts or improper service.

# HANDLE INSTALLATION GUIDE

**TOOLS NEEDED:** Phillips screwdriver #2.

**IMPORTANT: NEVER LAY THE BEVERAGE CENTER ON ITS BACK.**

The compressor and motor components are installed at the back of the unit and may easily be damaged if the beverage center is placed on its back.

**IMPORTANT: DO NOT USE STAINLESS STEEL HANDLE TO MOVE OR LIFT THE UNIT.**

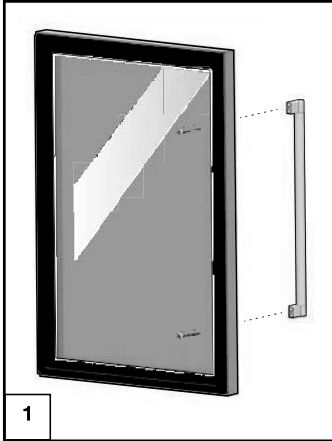

The stainless steel handle is easily attached to the left side of the glass door with two enclosed screws.

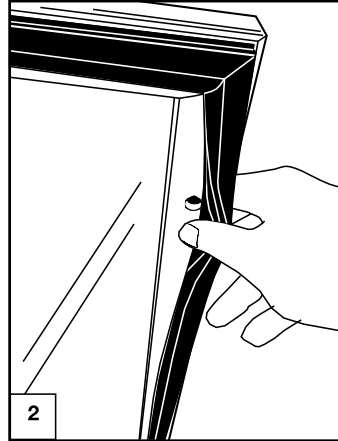

Carefully pull back the gasket from the interior door frame as indicated. Insert screws into holes on back side of door under the door gasket. Position the handle on the outside of the glass door.

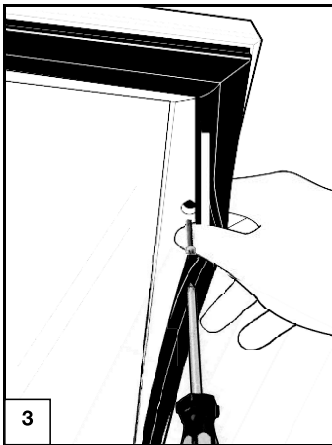

Tighten both screws until the door handle is flush with the stainless steel frame. Take care not to over tighten the screws, as this may damage the handle or frame.

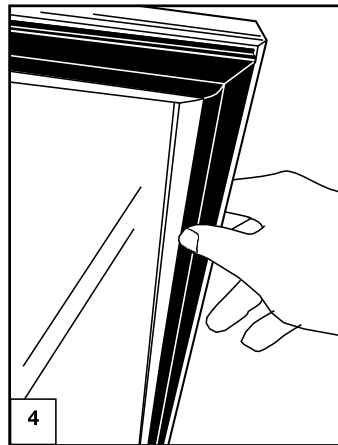

Gently press and thread the gasket back into the slot on the door frame. Ensure the gasket is properly seated prior to using the unit.

# TROUBLESHOOTING GUIDE

---

## WHAT TO DO ...

### When the unit is not in use for a prolonged period:

- Remove the plug from the outlet.
- Remove all contents from the unit.
- Dry the interior and leave the door open for a few days.

### When the unit does not work:

- Check if there is a power failure
- Check if the power plug is plugged into the power outlet
- Check that the fuse has not blown in main supply circuit

### When you wish to move the fridge:

- Secure all movable parts and contents. (Package them separately if necessary.)
- Transport the fridge only in an upright position. In any other position you may damage the compressor.

Before calling for service, please follow the checklist below. This may save you an expensive service call.

### If the unit seems too warm inside:

- Check to see that the door is closing properly and the door seal is not damaged.
- Check that the interior circulation is not obstructed by having too many goods stored. (The fridge is overloaded)
- Did you store anything hot, without first cooling it to room temperature?
- Is there sufficient clearance around all sides and above the fridge?
- Do you set the temperature too high?

### When the condensate water overflows inside the unit and onto the floor:

- Check that the drain pipe and the drain hose are not clogged.
- Check that the drain pan is housed properly.

### When condensation forms on the outside of the unit:

- Condensation may form on the outside when the humidity level is high such as during a wet season. This is the same result as the condensation formed when chilled water is poured into a glass. It does not, therefore, indicate a failure, wipe dry with a dry cloth.

### If the fridge starts making any unusual noises:

- Is it wobbling? Re-level it and check if it now operates normally.
- Have any objects fallen behind the fridge? If so, remove them and check if operation is now normal.
- Are any containers inside the fridge vibrating or resonating? If so, rearrange them then check to see if operation has returned to normal.



If you are experiencing any issue with your unit, please contact us right away.  
Phone: 718-576-6342  
Email: support@koolmore.com

## Limited Service Warranty

**Valid only in the Continental United States**

### 1 Year Parts and Labor Warranty

Unless otherwise stated, Koolmore Supply Inc warrants to the original purchaser of new Koolmore ice machine units, that such equipment will be free from defects in material and workmanship for a period of 1 year from the date of delivery. Valid only in the Continental United States.

### 5 Year Compressor Warranty

In addition to the 1 year parts and labor warranty above, Koolmore Supply Inc warrants the compressor on select units to be free of defects in material and workmanship for a period of 5 years from the date of delivery.

On products without the 5 year compressor warranty, the compressor is covered for 1 year under the standard parts and labor warranty.

#### Coverage Limitations

The 1 year parts and labor warranty and 5 year compressor warranty do not cover:

- Failure to install and/or use equipment within proper operating conditions specified by Koolmore. This includes but is not limited to residential, outdoor, or mobile applications.
- Any adjustments necessitated by improper operating conditions.
- Improper water pressure or temperature, or failure to use and maintain a water filter, and any adjustments necessitated by these conditions. Failure to meet these conditions will void all future warranty coverage.
- Damage caused by improper electrical connection, power failure, or generators.
- Failure to properly maintain the unit including all preventative maintenance and cleaning.
- Equipment sold or used outside of the contiguous United States, equipment purchased second-hand, equipment sold by an unauthorized reseller, and equipment expressly sold without warranty coverage.
- Equipment without a valid serial number and proof of purchase, or other way to verify warranty coverage.
- Equipment that has not been used appropriately or was subject to misuse, neglect, abuse, accident, alteration, negligence, damage during transit, delivery or installation, fire, flood, or an act of God.
- Equipment that has been altered, modified, or repaired by anyone other than an authorized service agency outside of preventative maintenance and cleaning.
- Parts deemed by Koolmore to be normal wear and tear parts, including hoses and select plastic or rubber components.

#### For Warranty Inquiries or Service:

This warranty is only valid on equipment purchased from an authorized dealer.

- Locate the model number (located on the front of the unit, or inside the door jamb).

Next, call 1-718-576-6342. You must have the model number when contacting service technicians.

**Failure to contact Koolmore prior to obtaining equipment service may void your warranty**