



Item #636-538

Model #143-002-4SEC-OLE

USE AND CARE GUIDE

MILL VALLEY 4-PIECE FULLY WOVEN SECTIONAL SET

(1-Piece 40in. Square Cushioned Ottoman)

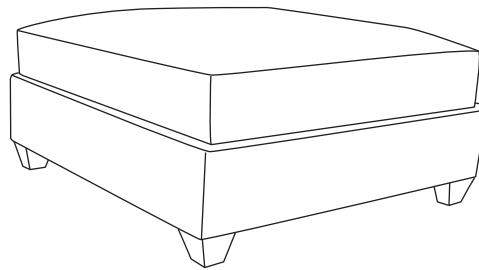

Questions, problems, missing parts? Before returning to the store,
call Hampton Bay Customer Service
8.00 a.m. - 6.00 p.m. EST, Monday - Friday

1-855-HD-HAMPTON

HAMPTONBAY.COM

THANK YOU

We appreciate the trust and confidence you have placed in Hampton Bay through the purchase of this 4-piece set. We strive to continually create quality products designed to enhance your home. Visit us online to see our full line of products available for your home improvement needs.

Thank you for choosing Hampton Bay!

Table of Contents

| | | | |
|---|---|-------------------------|---|
| Table of Contents..... | 2 | Pre-Assembly | 3 |
| Safety Information..... | 2 | Planning Assembly | 3 |
| Warranty | 2 | Hardware Included..... | 3 |
| Two Year Frame, Weave & Fabric Limited Warranty | 2 | Package Contents | 4 |
| What Is Covered | 2 | Assembly | 5 |
| What Is Not Covered | 2 | | |
| Care Instructions | 2 | | |

Safety Information



DANGER: Please keep children out of the assembly area during assembly.



CAUTION: Use the ottoman on flat ground only.



IMPORTANT: Please check the tightness of bolts at least every 180 days.

Warranty

TWO YEAR FRAME, WEAVE AND FABRIC LIMITED WARRANTY

WHAT IS COVERED

We warrant the frame, weave and fabric to be free of manufacturing defects to the original purchaser for two years.

WHAT IS NOT COVERED

It remains the customer's responsibility for freight and packaging charges to and from our service center. This warranty does not cover commercial use, hardware, acts of nature, fire, freezing and abusive use. In addition, purchased parts are not covered under this warranty. We reserve the right to make substitutions with similar merchandise, if the model in question is no longer in production.

Care Instructions

Before using, wipe with a clean, dry cloth. Do not use bleach or solvents. Treat the frame with one-step liquid wax for maximum protection against UV light and salty, damp air. When not in use, store the furniture in a cool, dry place. If your set includes cushions or mesh fabric, they may be cleaned by hand with a mild solution of soap and water. Rinse the cushions thoroughly and allow to drip dry. Do not machine wash or tumble dry, as the cushions may shrink. Do not use bleach or solvents on fabrics. When cleaning the table top make sure to use a soft, clean cloth that doesn't bleed color.

You may contact our customer service department with any questions by phone at 1-855-HD-HAMPTON or visit www.hamptonbay.com.

Pre-Assembly

PLANNING ASSEMBLY

It will take two persons about 10 minutes to complete the assembly process.

HARDWARE INCLUDED



NOTE: Hardware not shown to actual size.

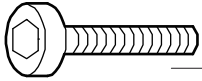

BB

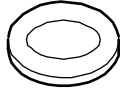

DD

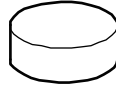

FF

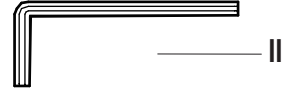

II

| Part | Description | Quantity |
|------|---------------|----------|
| BB | Bolt (M6x35) | 4 |
| DD | Washer (M6) | 4 |
| FF | Bolt cap (M6) | 4 |
| II | Hex wrench | 1 |

Pre-Assembly (continued)

PACKAGE CONTENTS

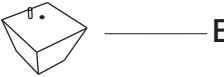
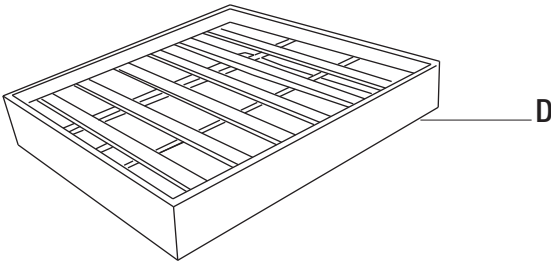

| Part | Description | Quantity |
|------|-------------------------|----------|
| D | Ottoman | 1 |
| E | Ottoman foot with glide | 4 |

Assembly

1 Attaching feet to the ottoman

- Place the ottoman on its side.
- Align the four feet (E) to the ottoman (D).
- Attach the feet to the ottoman with four bolts (BB) and four washers (DD) using wrench (II).
- Tighten all the bolts (BB) and cover them with bolt caps (FF).
- Stabilize the ottoman with the glide at the bottom of each foot.

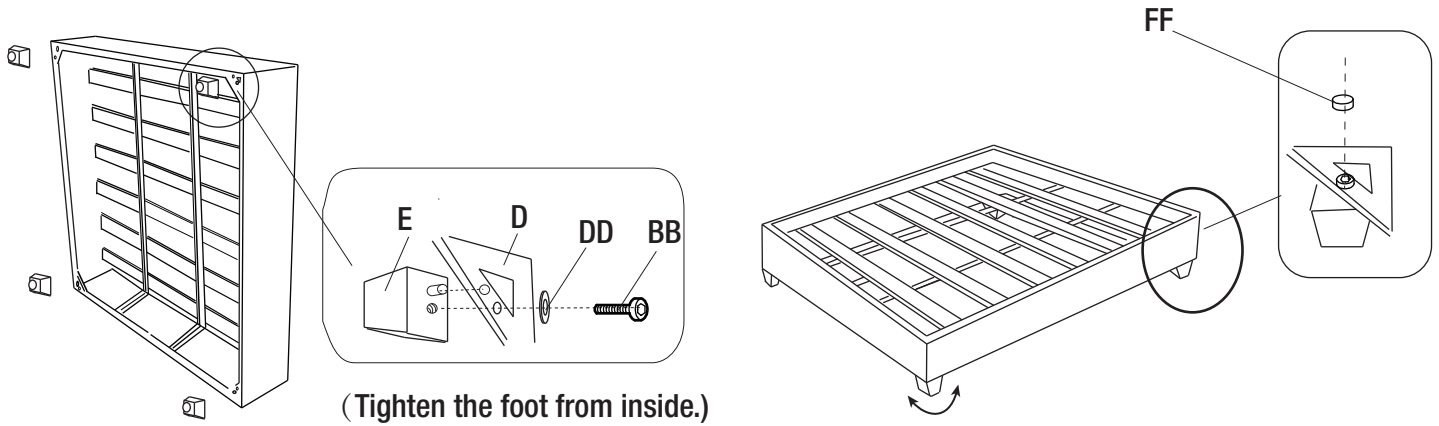

2 Placing the cushion

- Place the cushion into the ottoman.

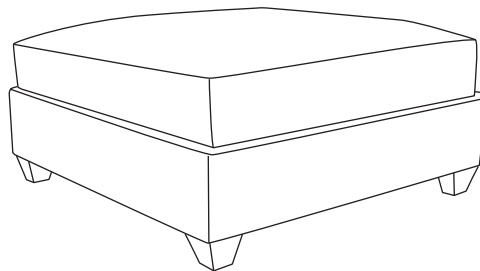



Questions, problems, missing parts? Before returning to the store,
call Hampton Bay Customer Service
8 a.m. - 6 p.m., EST, Monday-Friday

1-855-HD-HAMPTON

HAMPTONBAY.COM

Retain this manual for future use.