



OPERATOR'S MANUAL

MANUEL D'UTILISATION
MANUAL DEL OPERADOR

18 VOLT COMPACT BLOWER

SOUFFLEUR COMPACT DE 18 V
SOPLADORA COMPACTA DE 18 V

R86043

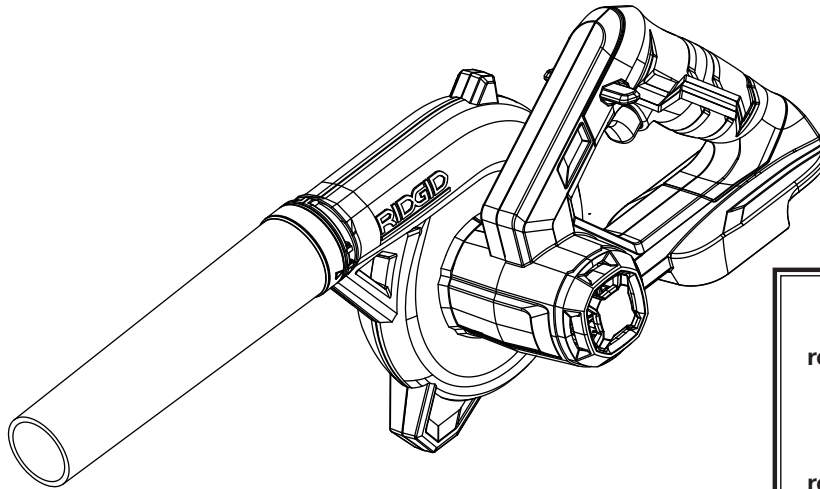

To register your RIDGID product, please visit:
register.RIDGIDpower.com

Pour enregistrer votre produit de RIDGID, s'il vous plaît la visite :
register.RIDGIDpower.com

Para registrar su producto de RIDGID, por favor visita:
register.RIDGIDpower.com

INCLUDES: Blower, Blower Tube, Inflator/Deflator Nozzle with Tapered Adaptor, Operator's Manual

TABLE OF CONTENTS

- Important Safety Instructions 2-3
- Symbols..... 4-5
- Features..... 5
- Assembly 5-6
- Operation..... 6-7
- Maintenance..... 8
- Illustrations 9-10
- Parts Ordering/ Service Back page

⚠ WARNING:

To reduce the risk of injury, the user must read and understand the operator's manual before using this product.

SAVE THIS MANUAL FOR FUTURE REFERENCE

INCLUT: Soufflante, tube de soufflante, buse de gonflage et dégonflage avec adaptateur effilé, manuel d'utilisation

TABLE DES MATIÈRES

- Règles de sécurité importantes..... 2-3
- Symboles..... 4-5
- Caractéristiques 5
- Assemblage 5-6
- Utilisation..... 6-7
- Entretien 8
- Illustrations 9-10
- Commande de pièces et réparation..... Page arrière

⚠ AVERTISSEMENT :

Pour réduire les risques de blessures, l'utilisateur doit lire et veiller à bien comprendre le manuel d'utilisation avant d'utiliser ce produit.

CONSERVER CE MANUEL POUR FUTURE RÉFÉRENCE

INCLUYE: Sopladora, tubo de la sopladora, boquilla de inflador/desinflador con adaptador cónico, manual del operador

ÍNDICE DE CONTENIDO

- Instrucciones importantes de seguridad 2-3
- Símbolos 4-5
- Características 5
- Armado 5-6
- Funcionamiento..... 6-7
- Mantenimiento..... 8
- Ilustraciones 9-10
- Pedidos de piezas y servicio Pág. posterior

⚠ ADVERTENCIA:

Para reducir el riesgo de lesiones, el usuario debe leer y comprender el manual del operador antes de usar este producto.

GUARDE ESTE MANUAL PARA FUTURAS CONSULTAS

IMPORTANT SAFETY INSTRUCTIONS

When using an electrical appliance, basic precautions should always be followed, including the following:

WARNING!

READ AND UNDERSTAND ALL SAFETY WARNINGS AND INSTRUCTIONS BEFORE USING THIS BLOWER. To reduce the risk of electric shock, fire and/or serious personal injury.

- **Know your power blower. Read operator's manual carefully. Learn its applications and limitations, as well as the specific potential hazards related to this blower.** Following this rule will reduce the risk of electric shock, fire, or serious injury.
- **Do not permit children to use blower.** It is not a toy. Close attention is necessary when used near children.
- **Use only accessories that are recommended by the manufacturer for your model described in this manual.** Accessories that may be suitable for one blower may create a risk of injury when used on another blower. Use only as described in this manual.
- **Do not handle charger, including charger plug, and charger terminals with wet hands.**
- **Do not put any object into openings. Do not use with any opening blocked; keep free of dust, lint, hair, and anything that may reduce air flow.**
- **Do not charge the unit outdoors.**
- **Keep hair, loose clothing, fingers, and all parts of body away from openings and moving parts.**
- **Turn off all controls before removing battery.**
- **Use extra care when cleaning on stairs or steps.**
- **Do not operate blowers in explosive atmospheres, such as in the presence of flammable liquids, gases, or dust.** Blowers create sparks which may ignite the dust or fumes.
- **Keep your work area clean and well lit.** Cluttered benches and dark areas invite accidents.
- **Keep bystanders, children, and visitors at least 50 ft. away while operating a blower.** Distractions can cause you to lose control.
- **A battery operated blower with integral batteries or a separate battery pack must be recharged only with the specified charger for the battery.** A charger that may be suitable for one type of battery may create a risk of fire when used with another battery.
- **Use battery operated blower only with specifically designated battery pack.** Use of any other batteries may create a risk of fire.
- **Use only with charger listed.** For use with 18V lithium-ion battery packs, see tool/appliance/battery pack/charger correlation supplement 988000-302.
- **Do not operate charger with a damaged cord or plug, which could cause shorting and electric shock.** If damaged, have the charger replaced by an authorized service center.
- **If appliance is not working as it should, has been dropped, damaged, left outdoors, or dropped into water, return it to a service center.**
- **Stay alert, watch what you are doing and use common sense when operating a power blower. Do not use blower while tired, upset, or under the influence of drugs, alcohol, or medication.** A moment of inattention while operating blowers may result in serious personal injury.
- **Secure long hair above shoulder level to prevent entanglement in moving parts.**
- **Avoid accidental starting. Be sure switch is in the locked or off position before inserting battery pack.** Carrying blowers with your finger on the switch or inserting the battery pack into a blower with the switch on invites accidents.
- **Use safety equipment. Always wear eye protection.** Dust mask, non-skid safety shoes, hard hat, or hearing protection must be used for appropriate conditions.
- **Do not wear loose clothing or jewelry. Contain long hair.** Loose clothes, jewelry, or long hair can be drawn into air vents.
- **Do not use on a ladder, rooftop, tree, or other unstable support.** Stable footing on a solid surface enables better control of the blower in unexpected situations.
- **Do not use blower if switch does not turn it on or off.** A blower that cannot be controlled with the switch is dangerous and must be repaired by an authorized service center or replaced.
- **Disconnect battery pack from blower before making any adjustments, changing accessories, or storing the blower.** Such preventive safety measures reduce the risk of starting the blower accidentally.
- **When battery pack is not in use, keep it away from other metal objects like: paper clips, coins, keys, nails, screws, or other small metal objects that can make a connection from one terminal to another.** Shorting the battery terminals together may cause sparks, burns, or a fire.
- **Check for misalignment or binding of moving parts, breakage of parts, and any other condition that may affect the blower's operation. If damaged, have the blower serviced before using.** Many accidents are caused by poorly maintained blowers.
- **Keep the blower and its handle dry, clean and free from oil and grease.** Always use a clean cloth when cleaning. Never use brake fluids, gasoline, petroleum-based products, or any strong solvents to clean your blower. Following this rule will reduce the risk of loss of control and deterioration of the enclosure plastic.



IMPORTANT SAFETY INSTRUCTIONS

- **Always wear safety glasses with side shields.** Everyday glasses have only impact resistant lenses. They are NOT safety glasses. Following this rule will reduce the risk of eye injury.
- **Always wear eye protection with side shields marked to comply with ANSI Z87.1 along with hearing protection when operating this equipment.**
- **Protect your lungs. Wear a face or dust mask if the operation is dusty.** Following this rule will reduce the risk of serious personal injury.
- **Protect your hearing. Wear hearing protection during extended periods of operation.** Following this rule will reduce the risk of serious personal injury.
- **Battery powered blowers do not have to be plugged into an electrical outlet; therefore, they are always in operating condition. Be aware of possible hazards when not using your battery powered blower or when changing accessories.** Following this rule will reduce the risk of electric shock, fire, or serious personal injury.
- **Do not expose a battery pack or appliance to fire or excessive temperature. Exposure to fire or temperature above 265°F may cause explosion.**
- **Don't expose blowers to rain or wet conditions.** Water entering a blower will increase the risk of electric shock.
- **Wear heavy long pants, long sleeves, boots, and gloves.** Avoid loose garments or jewelry that could get caught in moving parts of the machine or its motor.
- **Do not operate the equipment while barefoot or when wearing sandals or similar lightweight footwear.** Wear protective footwear that will protect your feet and improve your footing on slippery surfaces.
- **Keep firm footing and balance. Do not overreach.** Overreaching can result in loss of balance.
- **Check the work area before each use.** Remove all objects such as rocks, broken glass, nails, wire, or string which can be thrown or become entangled in the machine.
- **Do not point the blower nozzle in the direction of people or pets.**
- **Never run the unit without the proper equipment attached.** Always ensure the blower tubes are installed.
- **When not in use, blower should be stored indoors in a dry, locked up place—out of the reach of children.**
- **Do not hang unit so that the switch trigger is depressed.**
- **Keep all bystanders, children, and pets at least 50 ft. away.**
- **Do not dispose of a severely damaged or worn out battery pack or this blower by incinerating.** The battery can explode in fire.
- **Blower service must be performed only by qualified repair personnel.** Service or maintenance performed by unqualified personnel may result in a risk of injury.
- **When servicing a blower, use only identical replacement parts.** Follow instructions in the Maintenance section of this manual. Use of unauthorized parts or failure to follow Maintenance Instructions may create a risk of shock or injury.
- **Never use blower near fires, fireplaces, hot ashes, barbecue pits, etc.** Use near fires or ashes can spread fires and result in serious injury and/or property damage.
- **Never use blower to spread chemicals, fertilizers, or any other toxic substances.** Spreading these substances could result in serious injury to the operator or bystanders.
- **Never place blower on any surface, except a hard, clean surface when motor is running.** Gravel, sand, and other debris can be picked up by the air inlet and thrown at the operator or bystanders, causing possible serious injuries.
- **Store indoors.**
- **Under abusive conditions, liquid may be ejected from the battery; avoid contact.** If contact accidentally occurs, flush with water. If liquid contacts eyes, additionally seek medical help. Liquid ejected from the battery may cause irritation or burns.
- **Do not use a battery pack or appliance that is damaged or modified.** Damaged or modified batteries may exhibit unpredictable behavior resulting in fire, explosion or risk of injury.
- **Do not charge battery in a damp or wet location. Do not use, store, or charge battery packs or products in locations where the temperature is less than 50°F or more than 100°F. Do not store outside or in vehicles.**
- **Save these instructions.** Refer to them frequently and use them to instruct others who may use this tool. If you loan someone this tool, loan them these instructions also.











SAVE THESE INSTRUCTIONS

SYMBOLS

The following signal words and meanings are intended to explain the levels of risk associated with this product.

SYMBOL	SIGNAL	MEANING
	DANGER:	Indicates a hazardous situation, which, if not avoided, will result in death or serious injury.
	WARNING:	Indicates a hazardous situation, which, if not avoided, could result in death or serious injury.
	CAUTION:	Indicates a hazardous situation, that, if not avoided, may result in minor or moderate injury.
	NOTICE:	(Without Safety Alert Symbol) Indicates information considered important, but not related to a potential injury (e.g. messages relating to property damage).

Some of the following symbols may be used on this product. Please study them and learn their meaning. Proper interpretation of these symbols will allow you to operate the product better and safer.

SYMBOL	NAME	DESIGNATION/EXPLANATION
	Safety Alert	Indicates a potential personal injury hazard.
	Read Operator's Manual	To reduce the risk of injury, user must read and understand operator's manual before using this product.
	Eye and Hearing Protection	Always wear eye protection with side shields marked to comply with ANSI Z87.1 along with hearing protection when operating this equipment.
	Impeller Blades	Rotating impeller blades can cause severe injury.
	Wet Conditions Alert	Do not expose to rain or use in damp locations.
	Keep Bystanders Away	Keep all bystanders at least 50 ft. away.
	Long Hair	Failure to keep long hair away from the air inlet could result in personal injury.
	Blower Tube	Do not operate without tube in place.
	Loose Clothing	Failure to keep loose clothing from being drawn into air intake could result in personal injury.
	Ricochet	Thrown objects can ricochet and result in personal injury or property damage.
	Recycle Symbol	This product uses lithium-ion (Li-ion) batteries. Local, state or federal laws may prohibit disposal of batteries in ordinary trash. Consult your local waste authority for information regarding available recycling and/or disposal options.

SYMBOLS

Some of the following symbols may be used on this product. Please study them and learn their meaning. Proper interpretation of these symbols will allow you to operate the product better and safer.

SYMBOL	NAME	DESIGNATION/EXPLANATION
V	Volts	Voltage
min	Minutes	Time
—	Direct Current	Type or a characteristic of current
n_0	No Load Speed	Rotational speed, at no load
.../min	Per Minute	Revolutions, strokes, surface speed, orbits etc., per minute

FEATURES

PRODUCT SPECIFICATIONS

Air Velocity	160 MPH
Air Volume	110 CFM
Maximum Pressure (Inflating)	0.5 PSI
Duty Cycle (Inflating)	Continuous

ASSEMBLY

UNPACKING

This product requires assembly.

- Carefully remove the tool and any accessories from the box. All items listed in the **Includes** section must be included at the time of purchase.

WARNING:

Items in this *Assembly* section are not assembled to the product by the manufacturer and require customer installation. Use of a product that may have been improperly assembled could result in serious personal injury.

- Inspect the product carefully to make sure no breakage or damage occurred during shipping.
- Do not discard the packing material until you have carefully inspected and satisfactorily operated the product.
- If any parts are damaged or missing, please call 1-866-539-1710 for assistance.

WARNING:

If any parts are damaged or missing do not operate this product until the parts are replaced. Use of this product with damaged or missing parts could result in serious personal injury.

WARNING:

Do not attempt to modify this product or create accessories not recommended for use with this blower. Any such alteration or modification is misuse and could result in a hazardous condition leading to possible serious personal injury.

WARNING:

To prevent accidental starting that could cause serious personal injury, always remove the battery pack from the tool when assembling parts.

ASSEMBLY

ASSEMBLING THE BLOWER TUBE

See Figure 1, page 9.

- Align the tabs inside the blower tube with the slots on the blower outlet.
- Push the blower tube onto the blower outlet until it stops.
- Turn the blower tube clockwise until it is securely attached.
- To remove the blower tube, turn it counterclockwise until it stops and slide the blower tube off.

INSTALLING THE INFLATOR/DEFLATOR NOZZLE

See Figures 2 - 3, page 9.

To use this tool as an inflator or deflator instead of a blower, remove the blower tube and install the inflator/deflator nozzle. For inflation, install the nozzle on the blower outlet. For deflation, install the nozzle on the air intake.

To use the tool as an inflator:

- Remove the blower tube from the blower outlet.
- Align the tabs inside the inflator/deflator nozzle with the slots on the blower outlet.
- Push the inflator/deflator nozzle onto the blower outlet until it stops.
- Turn the inflator/deflator nozzle clockwise until it is securely attached.
- To remove the inflator/deflator nozzle, turn it counterclockwise until it stops and slide the nozzle off.

To use the tool as a deflator:

- Remove the blower tube from the blower outlet.
- Align the raised ribs on the inflator/deflator nozzle with the notches on the air intake.
- Push the inflator/deflator nozzle onto the air intake.
- To remove the inflator/deflator nozzle, pull it away from the air intake.

To use the tool as a blower:

- Remove the inflator/deflator nozzle.
- Install the blower tube onto the blower outlet as described previously.

OPERATION

WARNING:

Do not allow familiarity with products to make you careless. Remember that a careless fraction of a second is sufficient to inflict serious injury.

WARNING:

Always wear eye protection with side shields marked to comply with ANSI Z87.1, along with hearing protection. Failure to do so could result in objects being thrown into your eyes resulting in possible serious injury.

WARNING:

Do not use any attachments or accessories not recommended by the manufacturer of this product. The use of attachments or accessories not recommended can result in serious personal injury.

APPLICATIONS

You may use this product for the purposes listed below:

- Clearing hard surfaces such as driveways and walkways
- Keeping jobsite area free from residual dusts and other light debris
- Inflating large and small inflatables.
- Quickly deflating items

TO INSTALL/REMOVE BATTERY PACK

See Figures 4 and 5, pages 9 and 10.

WARNING:

Always remove battery pack from your tool when you are assembling parts, making adjustments, cleaning, or when not in use. Removing battery pack will prevent accidental starting that could cause serious personal injury.

OPERATION

To install:

- Insert the battery pack into the product as shown.
- Make sure the latches on each side of the battery pack snap in place and that battery pack is secured in the product before beginning operation.

WARNING:

Make sure the latches on the sides of the battery pack snap in place and the battery pack is fully seated and secure in the blower battery port before beginning operation. Failure to securely seat the battery pack could cause the battery pack to fall out, resulting in serious personal injury.

To remove:

- Depress the latches and remove the battery pack.
- For complete charging instructions, refer to the Operator's Manuals for your RIDGID battery pack and charger models.

STARTING/STOPPING THE BLOWER

See Figure 5, page 10.

The blower is equipped with a lock-on feature which is convenient when continuous operation for extended periods of time is required.

- **To turn the blower on:** Depress the switch trigger.
- **To turn the blower off:** Release the switch trigger.
- **To lock on:** Depress the switch trigger. Push the lock-on button and release the switch trigger.
- **To release:** Depress and release the switch trigger.

OPERATING THE BLOWER

See Figure 6, page 10

NOTE: Install the blower tube onto the blower outlet as described previously.

- To keep from scattering debris, blow around the outer edges of a debris pile. Never blow directly into the center of a pile.

- To reduce sound levels, limit the number of pieces of equipment used at any one time.
- Watch out for children, pets, open windows, or freshly washed cars, and blow debris safely away.
- After using blowers or other equipment, CLEAN UP! Dispose of debris properly.

INFLATING

See Figure 7, page 10

NOTE: Install the inflator/deflator nozzle onto the blower outlet as described previously.

- Insert the inflator/deflator nozzle into the air port on the inflatable item.
NOTE: For small inflatables, such as beach balls, attach the tapered adaptor over the inflator/deflator nozzle.
- Squeeze and hold the switch trigger to begin inflation.
- When the item is fully inflated, release the switch trigger to stop the flow of air.
- Remove the nozzle from the inflated item and close the item's air port.

NOTE: Maximum PSI for this unit is 0.5 PSI.

DEFLATING

See Figure 8, page 10

NOTE: Install the inflator/deflator nozzle onto the air intake as described previously.

- Insert the inflator/deflator nozzle into the air port on the inflatable item.
- Squeeze and hold the switch trigger to begin deflation.
- When the item is fully deflated, release the switch trigger to stop the tool.
- Remove the nozzle from the deflated item and close the item's air port.

NOTE: MAINTENANCE INFORMATION BEGINS ON PAGE 8 AFTER FRENCH AND SPANISH LANGUAGE SECTIONS. ILLUSTRATIONS START ON PAGE 9.

This product has a 90-Day Satisfaction Guarantee Policy, as well as a Three-year Limited Warranty. For Warranty and Policy details, please go to powertools.ridgid.com or call (toll free) 1-866-539-1710.