

**Part 1: Installing steel legs to pre-drilled base rails.**

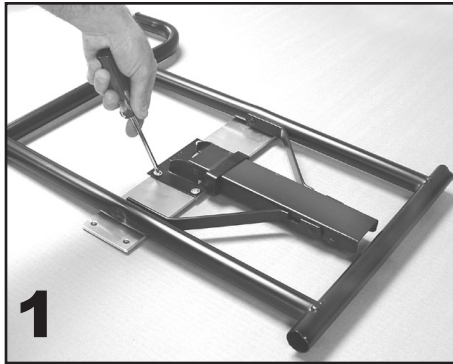

**1**  
Leave legs in folded position as they come out of the box. Install mounting plates as shown using #10 sheet metal screws.



**2**  
Turn brake over onto it's top. Place each leg assembly flat onto the base rails with the mounting plate toward the center of the brake. Place leg clamps over ends of leg tube and install into pre-drilled holes in base rails using screws provided.

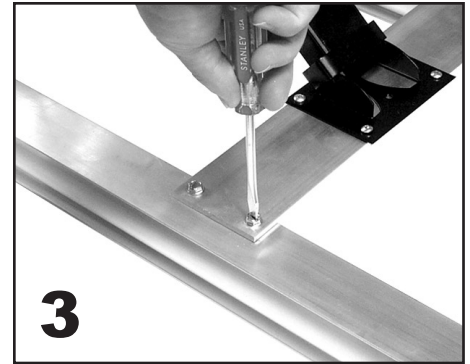

**3**  
Install mounting plates into pre-drilled holes in base rails as shown using screws provided in kit.

**Part 2: Installing steel legs to slotted base rails.**

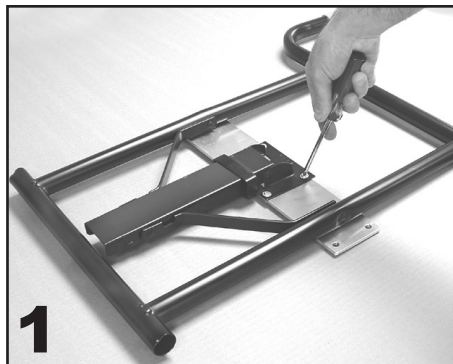

**1**  
Repeat Step 1 above. Leave leg folded.

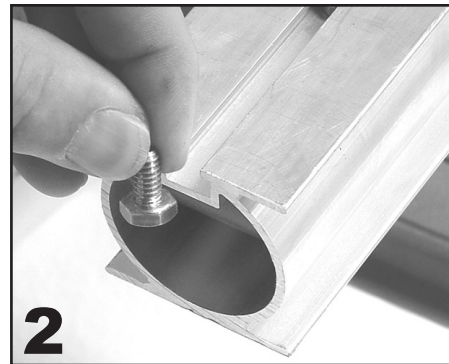

**2**  
Slide 2 bolts into each base rail slot.



**3**  
Align bolts with holes in mounting plate.

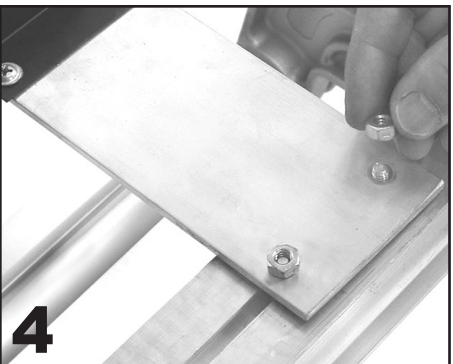

**4**  
Install 4 nuts finger-tight only for now.



**5**  
Slide 2 more bolts into each base rail slot.

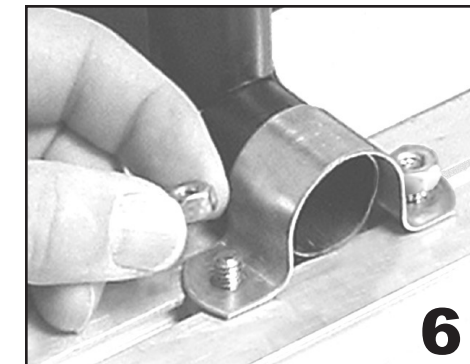

**6**  
Place U clamps over leg tube ends and install nuts finger-tight only for now.

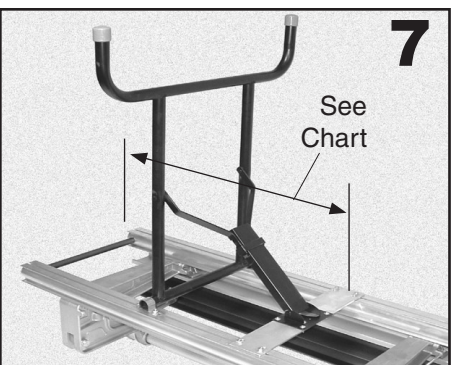

**7**  
Use chart on right to determine proper leg placement from end of brake.

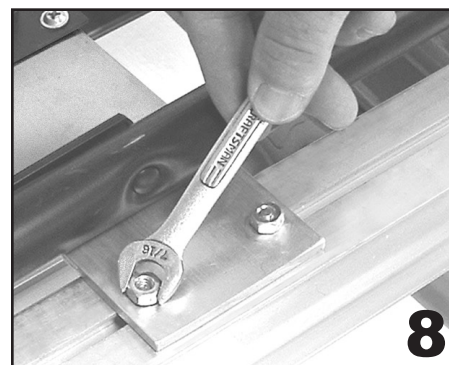

**8**  
Tighten all nuts in place. Fold legs flat then upright to ensure proper installation.

**Leg Placement Chart**

The distance below is measured from center of the mounting plate to the end of base rails.

TrimMaster®	Mark I Series	Distance from end
TM4/4HD.....	M4/4HD .....	15"
TM6/6HD.....	M6/6HD .....	15"
TM8/8HD.....	M8/8HD .....	28"
TM10/10HD....	M10/10HD .....	39"
TM12/12HD....	M12/12HD .....	45"
TM14/14HD....	M14/14HD .....	52"

24145 Industrial Park Dr., Farmington Hills, MI 48335  
Toll Free No. 1-800-Van Mark Toll Free Fax 1-888-Van Mark  
Local Phone No. 1-248-478-1200 Local Fax No. 1-248-478-1226  
Web site: www.van-mark.com E-mail sales@van-mark.com