

# ASSEMBLY INSTRUCTION

Ax1

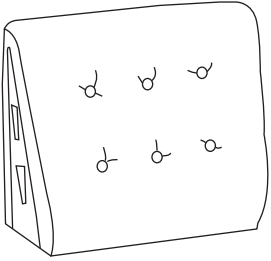

Bx1

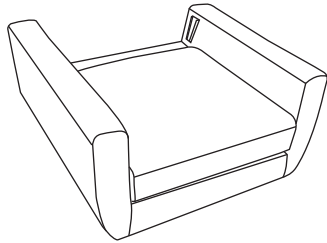

Ex4

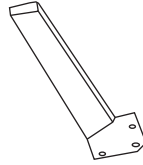

Fx12

M6X20

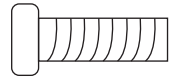

Cx1

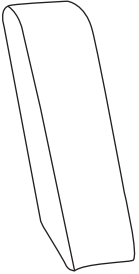

Dx1

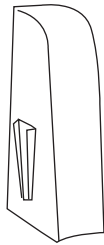

Gx4



Hx1

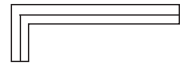

1

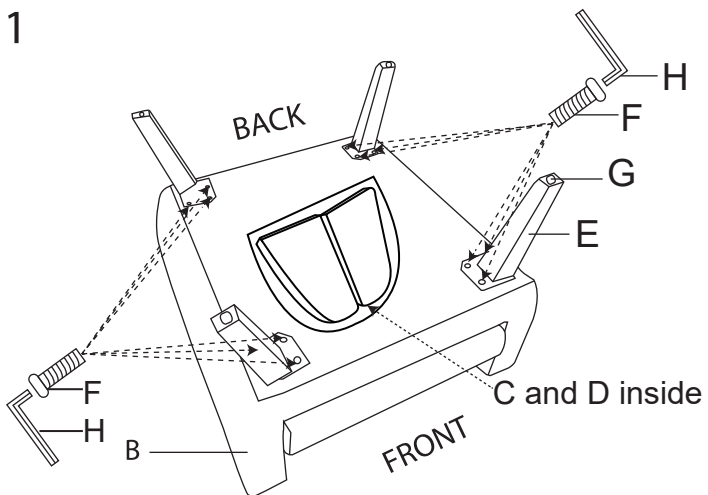

3

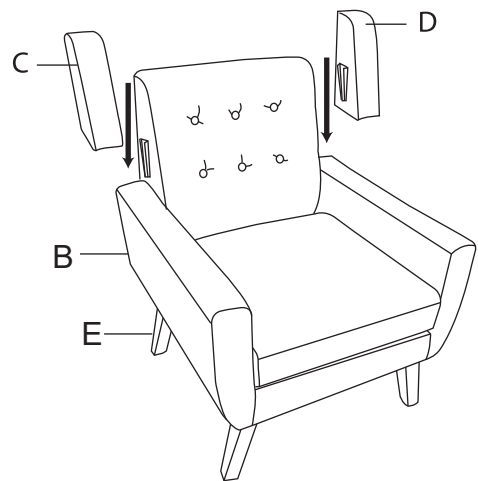

2

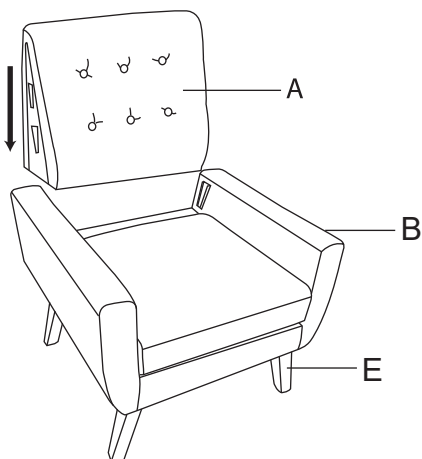

4

