

# Assembly Instructions

DINING TABLE • 96" W x 36" D x 30" H

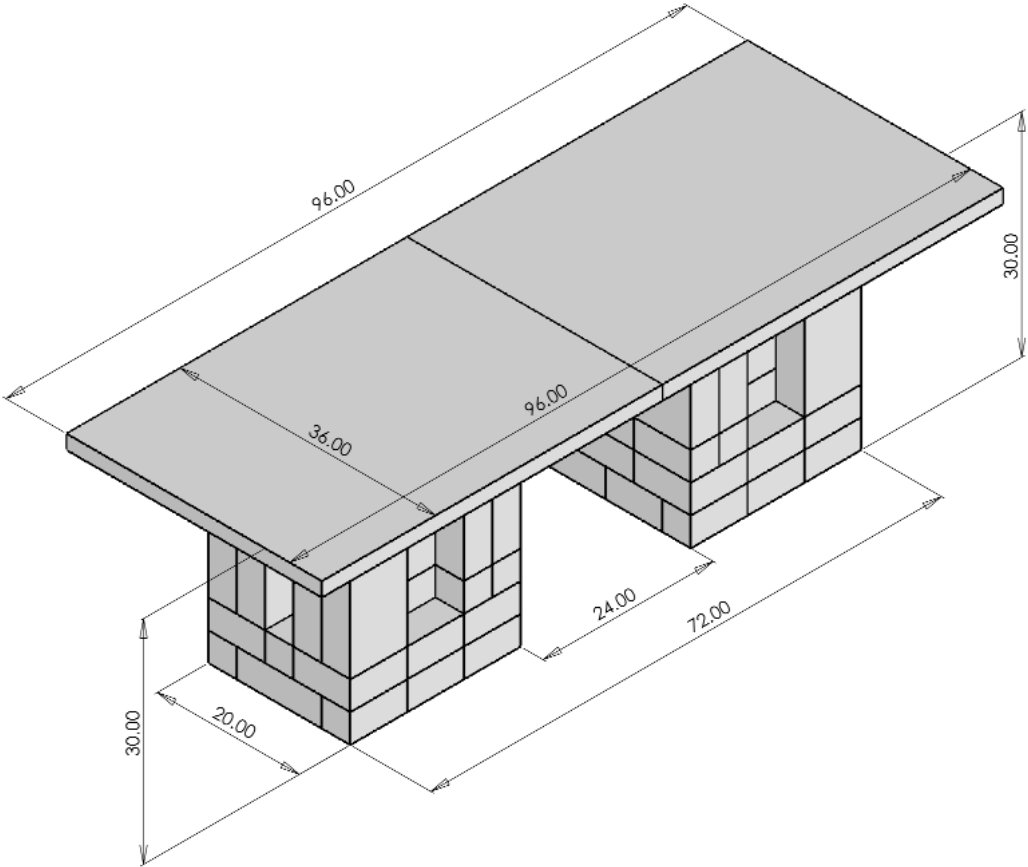

*necessaries*<sup>™</sup>  
kits for outdoor living

**ROCKWOOD**<sup>®</sup>  
RETAINING WALLS  
*A better way.*<sup>™</sup>

## Dining Table Kit – Contents

<u>Item</u>	<u>Description</u>	<u>Quantity</u>
4 x 12 x 8"	Large Lakeland Block (L)	32
4 x 8 x 8"	Medium Lakeland Block (M)	32
4 x 4 x 8"	Small Lakeland Block (S)	29
4 x 8 x 8"	Lakeland Block Cut (A)	4
36 x 48"	Silver Creek, Rock Faced 3 sides	2
Angle Iron	Supports	2
Adhesive	29 oz. Tubes Super-Stik	2

Lakeland™ blocks have the sophisticated look of an old brick wall so popular with homeowners today. This tumbled, three piece system offers designers the opportunity and freedom to combine functionality with style. Lakeland blocks can be used to build random-pattern outdoor fireplaces, kitchens, islands, garden and seat walls, pillars, planters, and more.

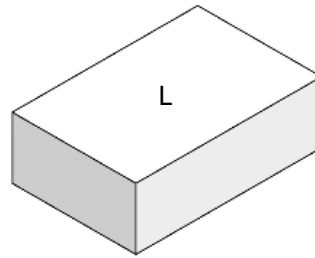

Large Block  
Size: 4" H x 8" W x 12" D  
Weight: 31 lbs

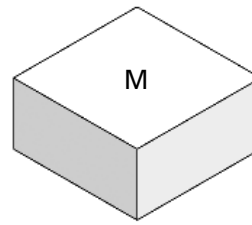

Medium Block  
Size: 4" H x 8" W x 8" D  
Weight: 20 lbs.

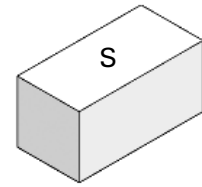

Small Block  
Size: 4" H x 4" W x 8" D  
Weight: 10 lbs.

### Copyright notice, please read:

The plans and instructions contained in this kit and the three-dimensional [Dining Table] design constructed from the use of this kit are protected under the U.S. Copyright Act. Reproduction of the plans, instructions or the [Dining Table] design, either in whole or in part, and whether in two-dimensional or three-dimensional form, and the creation of new works based upon such plans, instructions or [Dining Table] design, without the prior written permission of Rockwood Retaining Walls, Inc. is strictly prohibited. The purchase of a genuine kit from Rockwood Retaining Walls, Inc. or an authorized Rockwood dealer provides the purchaser with a limited license to construct a single [Dining Table]. Any reproduction of the plans and/or instructions, or the construction of more than a single [Dining Table] is a violation of Rockwood's copyrights and can result in severe penalties.

**ROCKWOOD®**  
RETAINING WALLS

*A better way.™*

Visit us on the web at:  
[www.rockwoodwalls.com](http://www.rockwoodwalls.com)

**Base Preparation:** Base can be constructed of either poured slab or compacted gravel. See requirements below.

**Zoning and Permits:** Before you plan your project, learn about the necessary zoning requirements and rules for excavating and building in your area. No matter how small your project, be sure you obtain the necessary permits before you start construction.

**Know What's Below:** Whether you are planning to do it yourself or hire a professional, smart digging means calling 811 before each job. Homeowners often make risky assumptions about whether or not they should get their utility lines marked, but every digging job requires a call – even small projects like planting trees and shrubs.

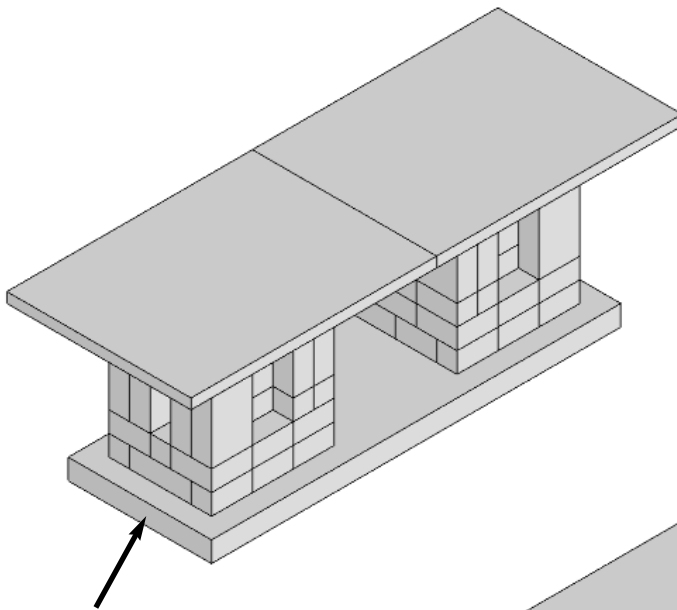

**Concrete Base Foundation:**

- 4" deep
- 4" outside perimeter of base
- Reinforce with 6" x 6" no. 10 WWM
- Compact sub-base soils to 95% of standard proctor (ASTM D698)

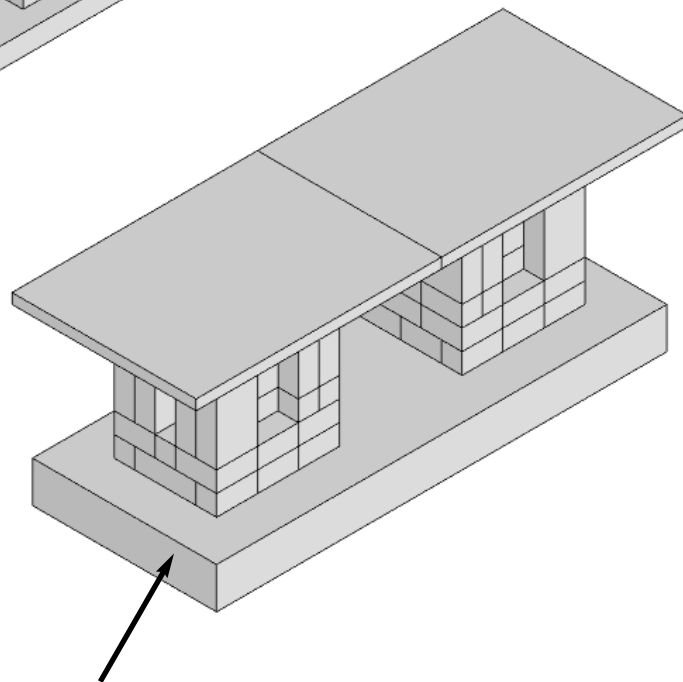

**Aggregate Base Foundation:**

- 6" deep
- 8" outside perimeter of base
- Compact sub-base soils to 95% of standard proctor
- Compact aggregate base to 95% of standard proctor (ASTM D698)

# Course 1

Be sure your properly prepared base is level. Begin building by laying your base course as shown. Square both base courses.

Using a stiff brush, remove all debris and dust from each block surface to be glued.

**IMPORTANT:** Lay glue bead away from outside perimeter to prevent glue from squeezing out between courses.

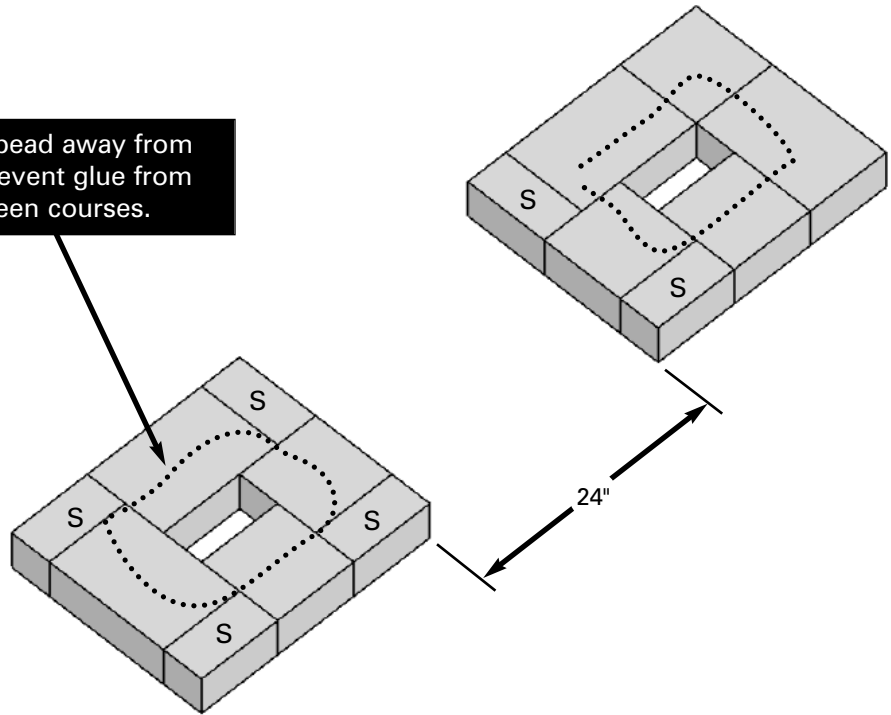

# Course 2

Continue to build each course as shown. Use adhesive on each block.

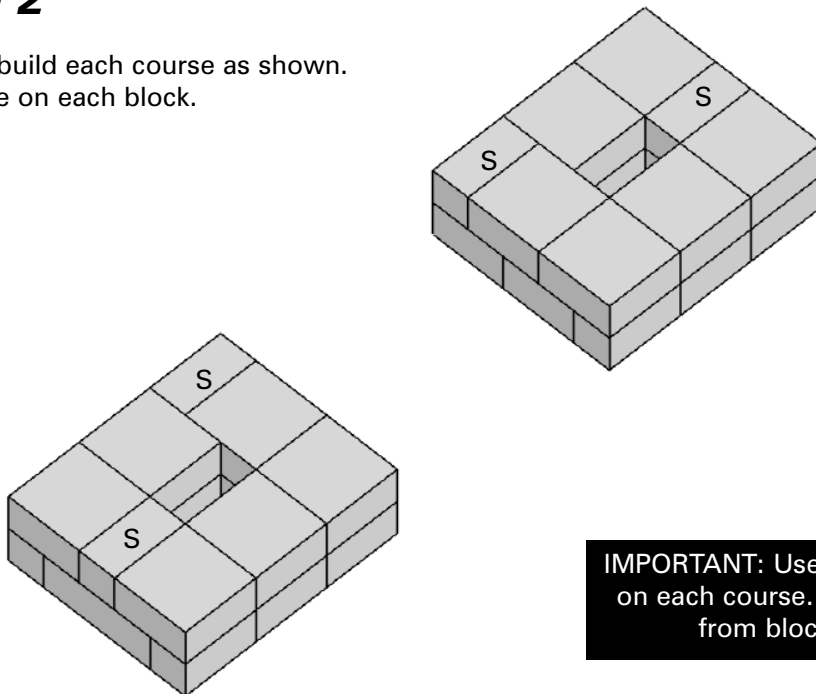

**IMPORTANT:** Use Super-Stik™ adhesive on each course. Brush excessive dust from blocks to be glued.

# Course 3

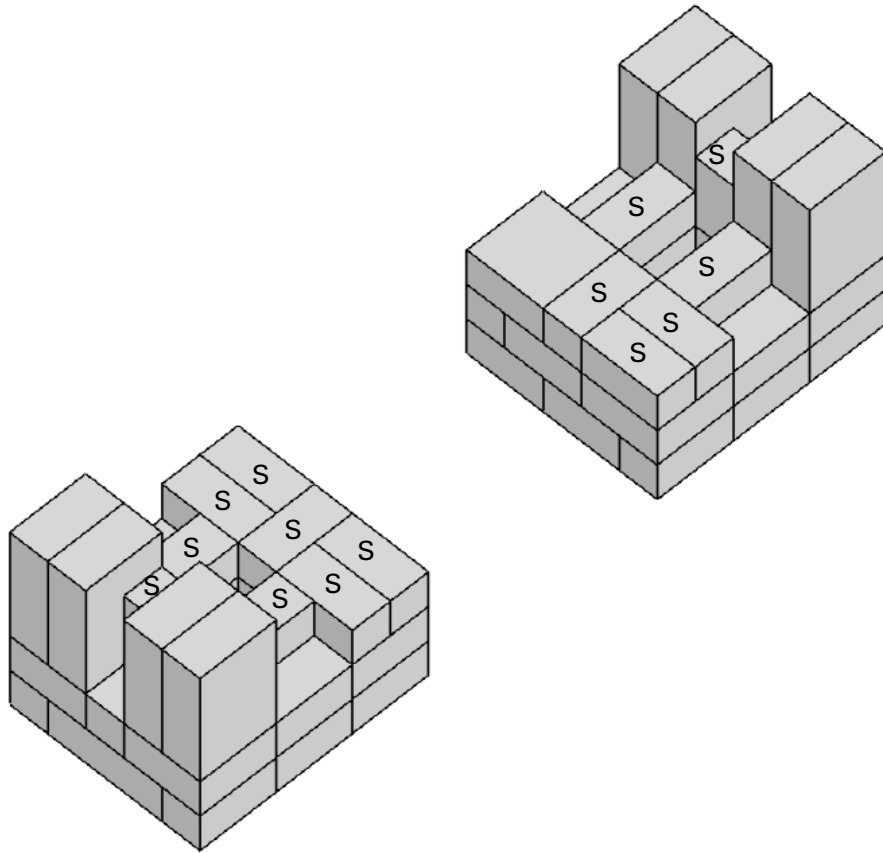

# Course 4

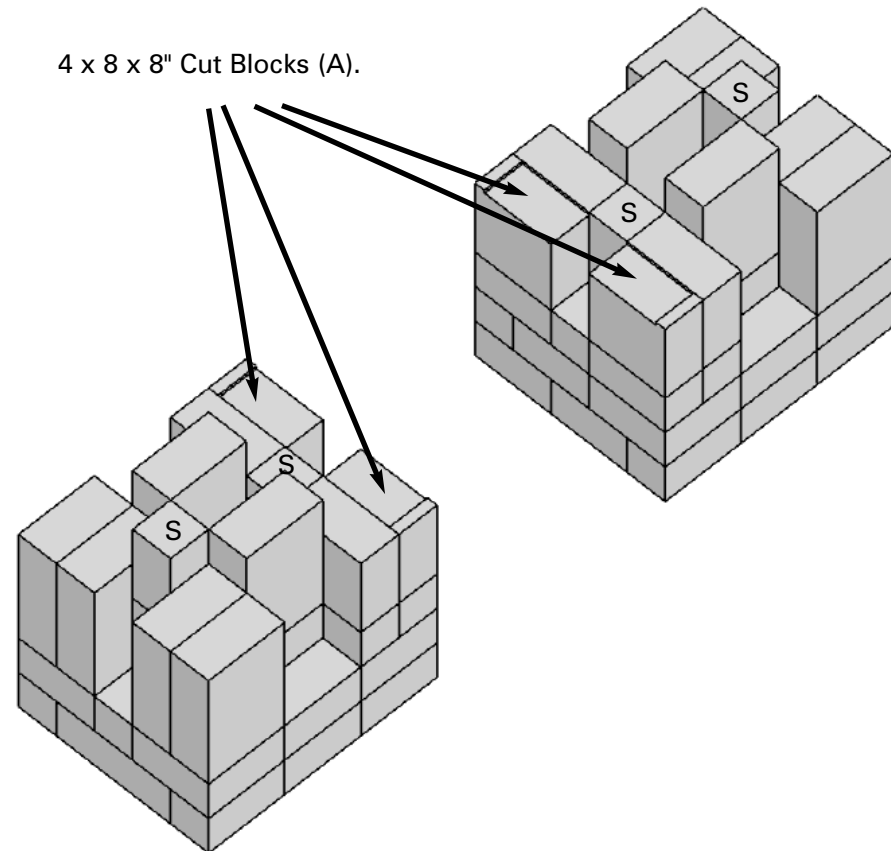

## ***Course 5***

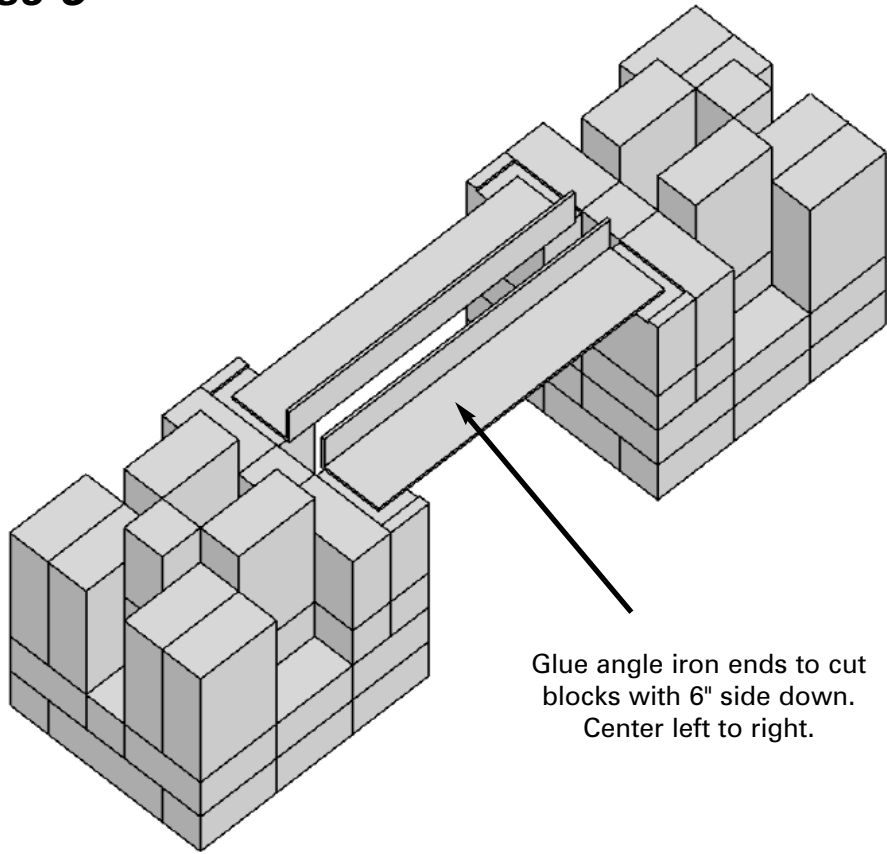

## ***Course 6***

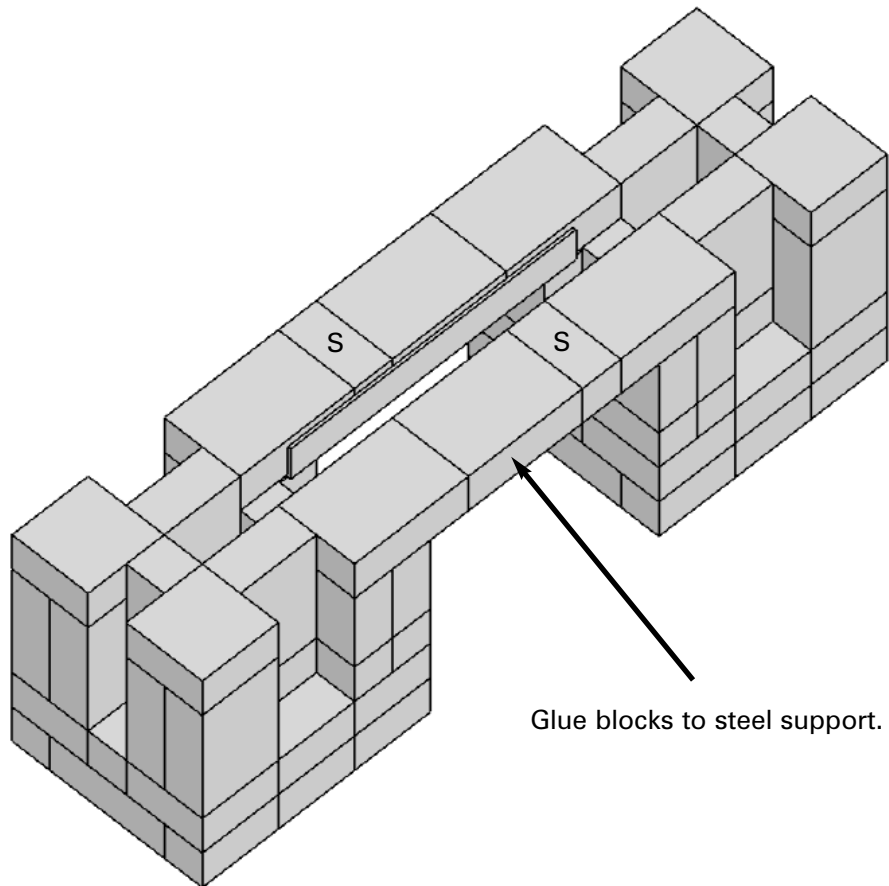

## ***Course 7***

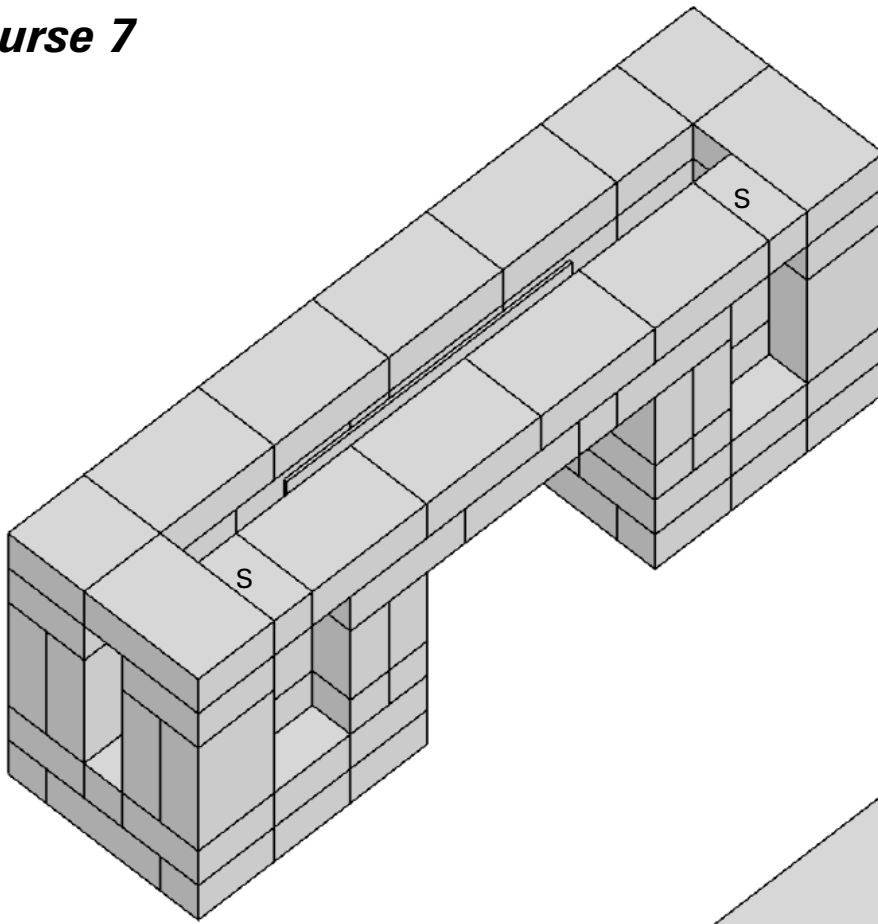

## ***Final Step***

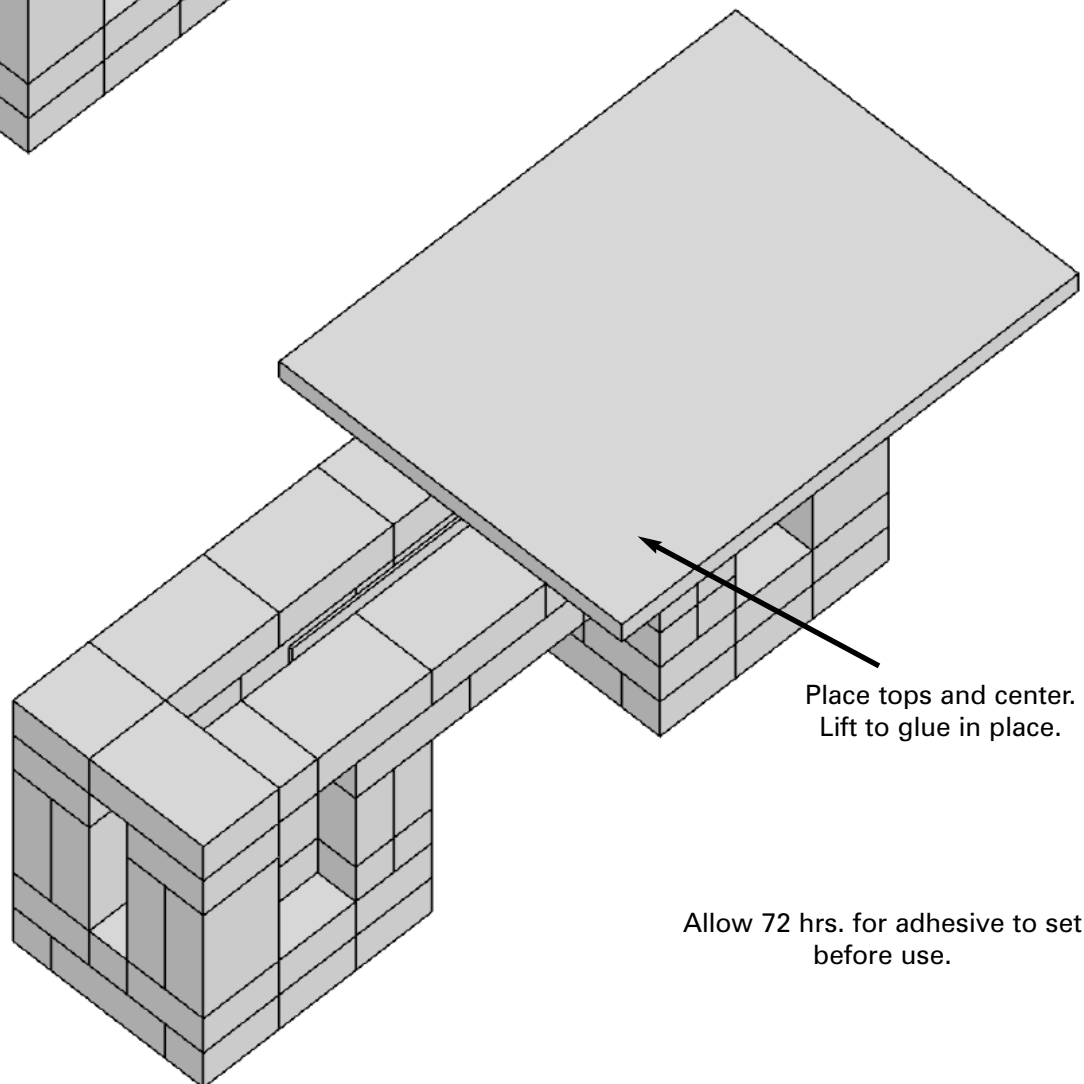

# Necessaries Outdoor Living Kits

Kit specifications, style and availability are subject to change without notice.

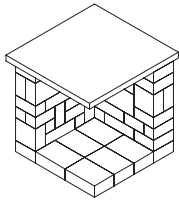

**Compact Woodbox**  
\$850 msrp

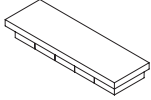

**Compact Hearth**  
\$255 msrp

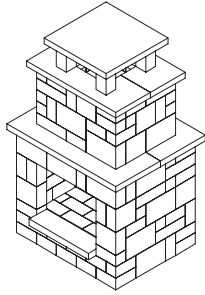

**Compact Fireplace**  
\$1,990 msrp

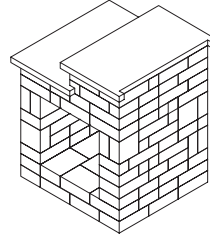

**Grand Woodbox**  
\$1,300 msrp

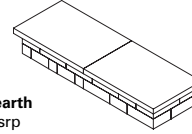

**Grand Hearth**  
\$700 msrp

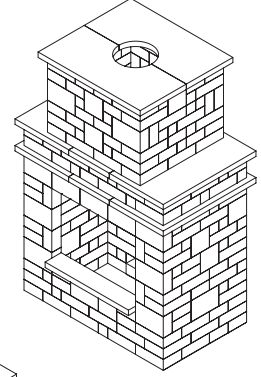

**Grand Fireplace**  
\$7,000 msrp

**Grand Island Bar**  
\$2,500 msrp

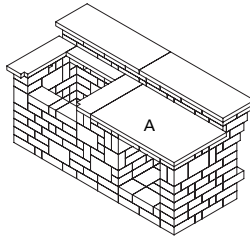
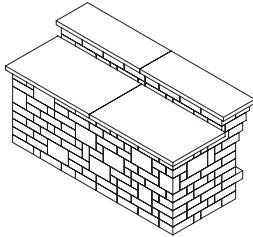

**– Grand Island Bar/Grill Series –**  
*Includes Vermont Castings Grill*  
\$5,290 msrp

(A) with storage and stainless steel door  
or  
(B) with storage, stainless steel door and  
refrigerator opening

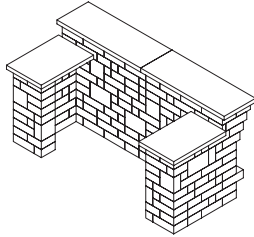
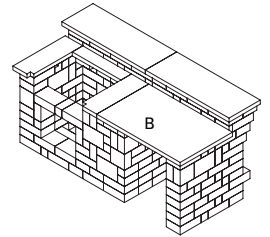

**Grill Surround**  
\$1,995 msrp

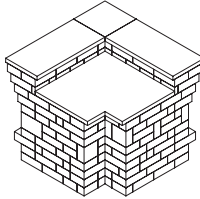

**Corner Return**  
\$2,500 msrp

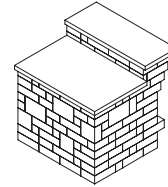

**Bar Section 4'**  
\$1,495 msrp

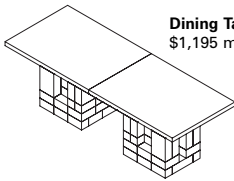

**Dining Table**  
\$1,195 msrp

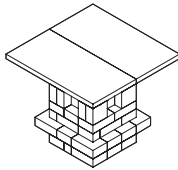

**High Top Table**  
\$900 msrp

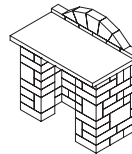

**Compact Bar w/20" Opening**  
\$995 msrp

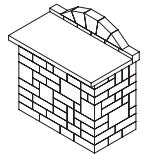

**Compact Bar**  
\$995 msrp

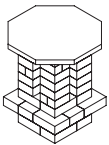

**Pub Table**  
\$600 msrp

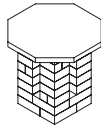

**Bistro Table**  
\$600 msrp

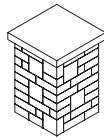

**24" Pillar**  
\$590 msrp

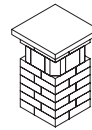

**20" Pillar w/Glass**  
\$710 msrp

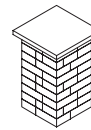

**20" Pillar**  
\$420 msrp

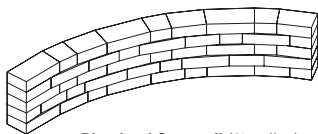

**Riverland Seatwall (8' radius)**  
\$350 msrp

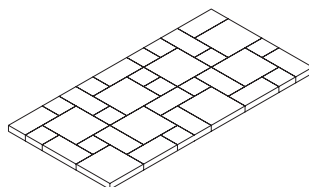

**Limestone and  
Slate Patio Kits: \$558 msrp**

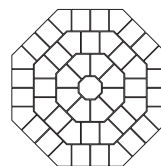

**Octant Kit, \$365 msrp  
Expansion Kit, \$337 msrp**

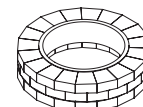

**Fire Ring and Insert, \$510 msrp  
W/Optional Cooking Grate, \$600 msrp**

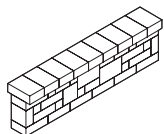

**Lakeland Seatwall**  
\$350 msrp



# Assembly Instructions

DINING TABLE • 96" W x 36" D x 30" H

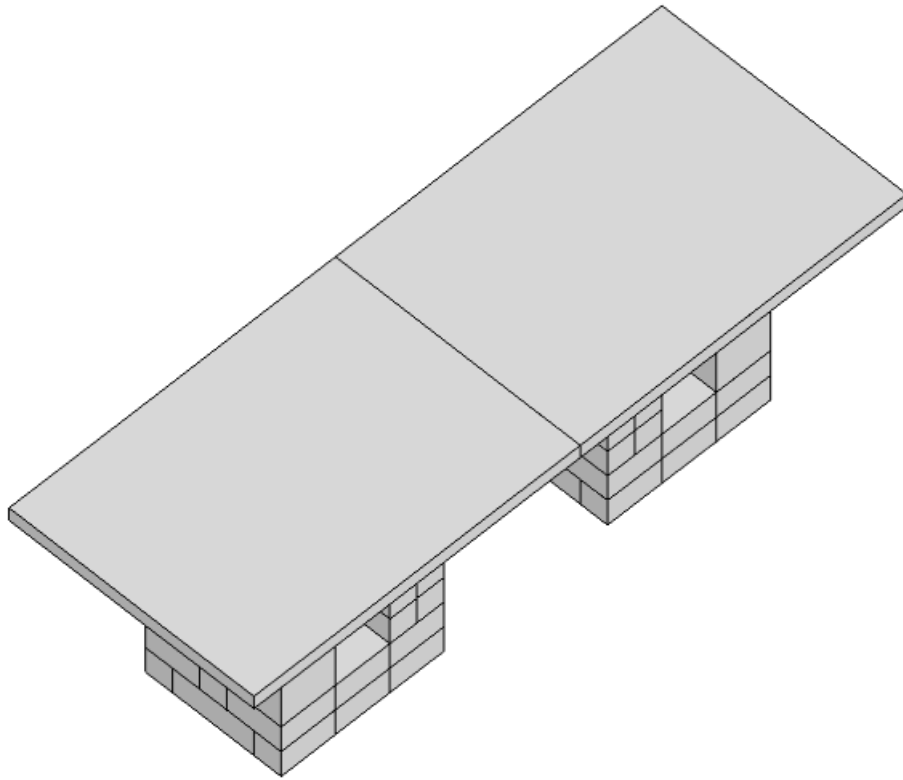

**ROCKWOOD**<sup>®</sup>  
RETAINING WALLS

*A better way.*<sup>™</sup>

325 Alliance Place NE  
Rochester, MN 55906

*toll free*

**888.288.4045**

*phone*

**507.529.2871**

*fax*

**507.529.2879**

[www.rockwoodwalls.com](http://www.rockwoodwalls.com)

Available at: \_\_\_\_\_