





# EASY TO INSTALL

-  **1** Clean the surface to be covered using a cleaning agent.  
Nettoyer la surface à couvrir avec un produit dégraissant.
-  **2** Draw a leveled guide line.  
Dessiner une ligne guide à niveau.
-  **3** Make the first cut.  
Couper la tuile.
-  **4** Remove the plastic protector on the back of the tile. Ensure that the adhesive remains untouched.  
Retirer la pellicule à l'arrière de la tuile. Faire attention de ne pas toucher l'adhésif.
-  **5** Align the adhesive tile.  
Aligner la tuile autocollante.
-  **6** Install the tile. Overlap grout lines.  
Coller en superposant les lignes des joints.

**IMPORTANT:** For the installation around a gas stove, please ensure that the following instructions are followed in order to avoid any direct contact between the tiles and the flames. If your stove does not have a back panel or metal cover, it is important to leave a space free of tiles. Do not install tiles less than 16 inches away from the top of the stove.

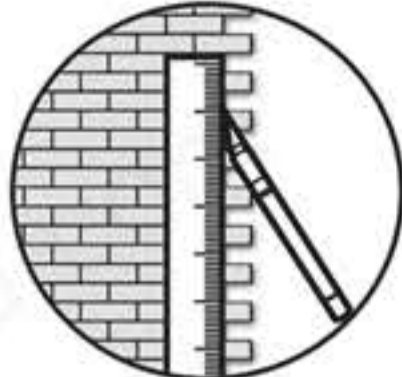
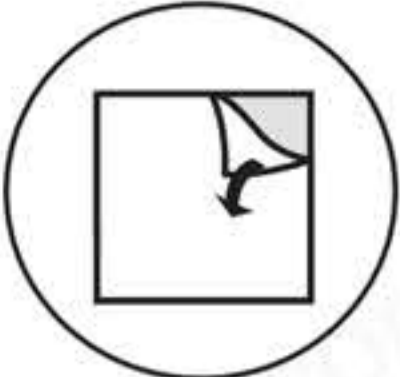
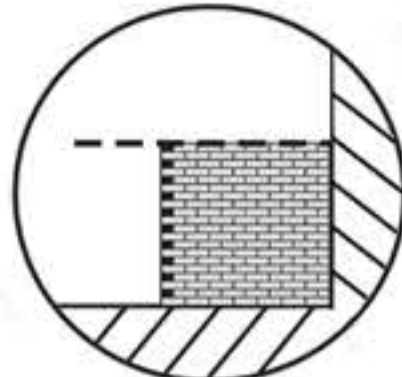
- Do not use these tiles in a shower enclosure, as this will affect the adhesive components of the tiles.
- Do not touch the adhesive on the back of the tiles, as this might weaken its performance.
- Do not use these as a countertop covering surface.

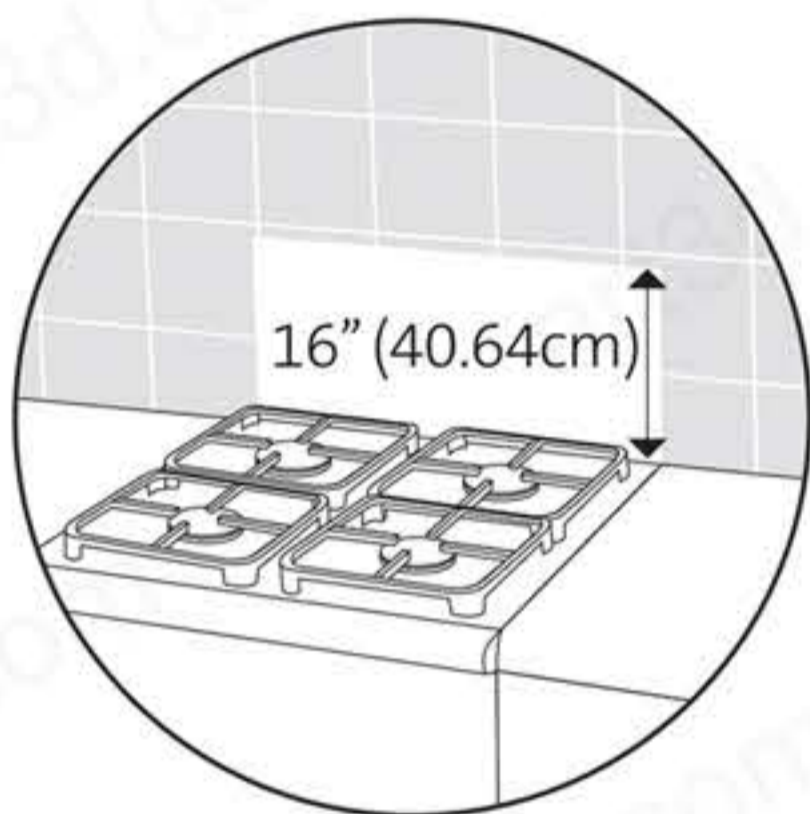

Gas stove WITH NO back control panel or metal cover.

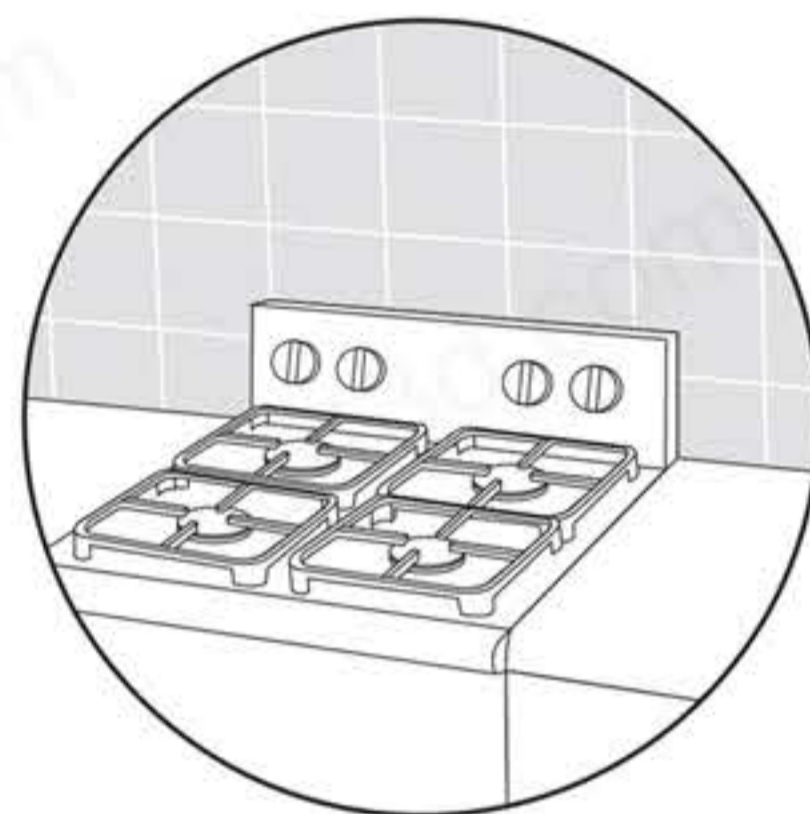

Gas stove WITH back control panel or metal cover.

# WARNING:

We analyzed and found that over 95% of complains about peeling off are from latex wall or repainted wall.



For latex / repainted walls, please follow the instruction:

-  **1** Sand the surface with sanding paper
-  **2** Clean the wall with damp cloth
-  **3** Wait until the wall is totally dry
-  **4** Spray the adhesive more on the joint area on both wall and stickers
-  **5** Be careful of the first cut and apply the cut edge to the corner of the wall

It is very important to make your first cut and apply the cut edge to the corner of the wall.

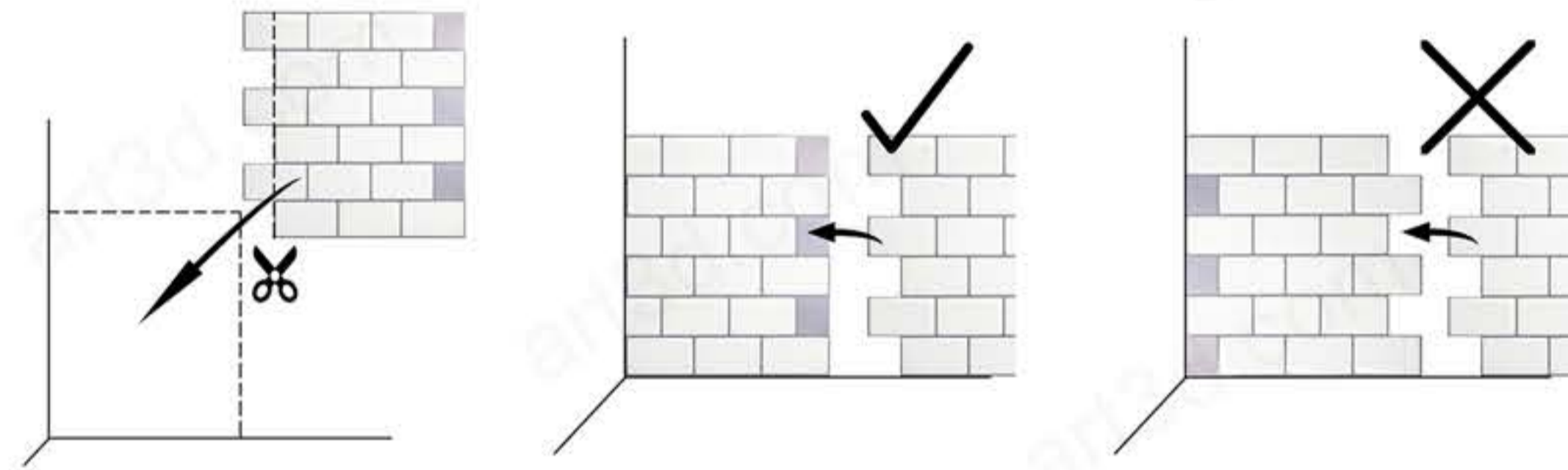

## Recommended Surface



-   Ceramic Tile Wall
-   Glass Wall
-   Acrylic Panel
-   Mirror
-   Painted Gypsum
-   Stainless
-   Laminate

## Non Recommended Surface

-   Brick Wall
-   Stone Wall
-   Gypsum Wall
-   Stucco Wall
-   Plywood Wall
-   Not in the Shower
-   Oily Wall