

## CAUTION

READ INSTRUCTIONS CAREFULLY FOR SAFE  
INSTALLATION AND FAN OPERATION. IF UNSURE CONSULT  
A QUALIFIED ELECTRICIAN

## THANK YOU FOR YOUR PURCHASE

Thank you for purchasing this quality product. To ensure correct function and safety, please read and save all instructions before using the product



### SAFETY RULES

1. To reduce the risk of electric shock, insure electricity has been turned off at the circuit breaker or fuse box before beginning.
2. All wiring must be in accordance with the National Electrical Code and local electrical codes. Electrical installation should be performed by a qualified licensed electrician.
3. **WARNING:** To reduce the risk of electrical shock and fire, do not use this fan with any solid-state fan speed control device.
4. **WARNING:** To reduce the risk of fire, electric shock, or personal injury, mount to outlet box marked "Acceptable for Fan Support of 45kg (99.12 lbs.) Or Less" and use mounting screws provided with the outlet box. Most outlet boxes commonly used for the support of light fixtures are not acceptable for fan support and may need to be replaced. Due to the complexity of the installation of this fan, a qualified licensed electrician is strongly recommended.
5. The outlet box and support structure must be securely mounted and capable of reliably supporting a minimum of 45KGS. Use only UL Listed outlet boxes marked FOR FAN SUPPORT.
6. The fan must be mounted with a minimum of 7 feet clearance from the trailing edge of the blades to the floor.
7. Avoid placing objects in the path of the blades.
9. To avoid personal injury or damage to the fan and other items, be cautious when working around or cleaning the fan.
10. Do not use water or detergents when cleaning the fan or fan blades. A dry dust cloth or lightly dampened cloth will be suitable for most cleaning.
11. After making electrical connections, spliced conductors should be turned upward and pushed carefully up into the outlet box. The wires should be spread apart with the grounded conductor and the equipment-grounding conductor on one side of the outlet box.
12. Electrical diagrams are for reference only.
13. The fan is suitable for indoor use only.

### TECHNICAL INFORMATION

SKU	Rated Voltage	Rated power(motor)	Light CCT.
F4601WH	110-120V AC	56W	4000K
F4601Y	110-120V AC	56W	3000K
F4601	110-120V AC	56W	4000K
F4601BZ	110-120V AC	56W	3000K
F4601BK	110-120V AC	56W	4000K

### BEFORE INSTALLATION

Unpack your fan and check the contents. You should have the followings:

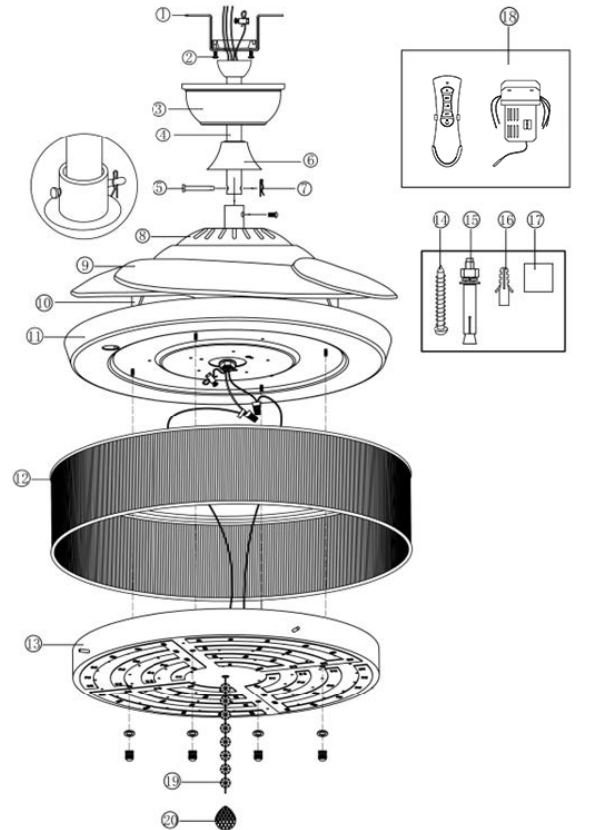

- |                            |                            |                           |
|----------------------------|----------------------------|---------------------------|
| 1. Mounting bracket x1     | 8. Top housing x 1         | 15. Expansion screw x 2   |
| 2. Canopy screws x 2       | 9. Blades x 4              | 16. Plastic anchor x 2    |
| 3. Canopy x 1              | 10. Fan motor assembly x 1 | 17. Balance tapes x 4     |
| 4. Downrod&hanger ball x 1 | 11. Base plate x 1         | 18. Remote control x 1set |
| 5. Bolt x 1                | 12. Lamp shade x 1         | 19. Crystal chain x 61    |
| 6. Coupling cover x 1      | 13. Light pan x 1          | 20. Crystal bead x 61     |
| 7. Pin x 1                 | 14. Wood screws x 2        |                           |

### INSTALLING THE FAN

Tools Required: Phillips screwdriver, Pair of pliers, straight slot screwdriver, adjustable wrench, step ladder, and wire cutters.

#### INSTALLING THE MOUNTING BRACKET

The ceiling fan must be installed in a location so that the blades are 300mm spacing from the tip of the blade to the nearest objects or walls. When hanging the Fan REMEMBER to turn off the power. Follow the instruction below to hang your fan properly:

1. For the concrete ceiling, drill two holes in the ceiling and secure the mounting bracket to the ceiling with two  $\Phi 8$  (distance between the two holes should be appropriate) expansion screws, flat washers, nuts provided and tighten with a spanner.

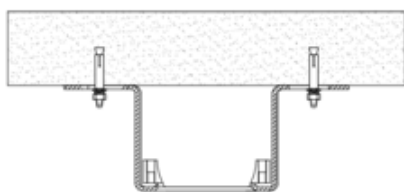

2. For the wood ceiling, Secure the mounting bracket to the ceiling is capable of carrying a load of at least 45KGS with two long mounting screws and washers provided. Be sure at least 30mm of the screw is threaded into the support.

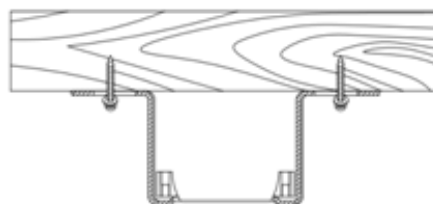

3. Refer to the Fig. in right for mounting when the ceiling is angled max. 15 degree angle.

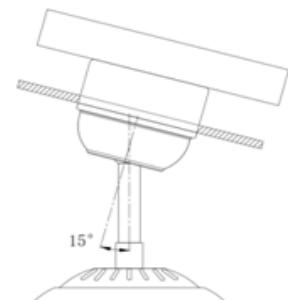

NOTE:Hanger after the installation must be able to withstand the weight of 45kg or more

## INSTALL THE DOWNROD

Hanging the Fan REMEMBER to turn off the power. Follow the steps below to hang your fan properly:

- 1) Remove the bolt, lock pin and set screws from the top of the housing assembly
- 2) Route wires exiting from the top of the fan motor through the coupling cover, canopy and then through the ball / downrod.
- 3) Align the holes at the bottom of the downrod with the holes in the coupling on top of the top housing .
- 4) Carefully insert the Bolt through the holes in the Coupling and downrod. Be careful not to jam the Bolt against the wiring inside the downrod. Insert the locking pin through the hole near the end of the Bolt until it snaps into its locked position.
- 5) Tighten two set screws on top of the fan housing firmly

### Changing the Downrod (Optional)

NOTE: Your fan comes with a 25cm downrod attached to the hanger ball. In addition, a 10cm downrod has been provided to be used in case the ceiling is lower. In this case, perform the following steps for correct installation:

1. Remove the hanger ball from downrod by loosening the setscrew at the top of the downrod which holds the hanger ball to the downrod.
2. Slide the hanger ball down the downrod and remove the support pin.
3. Insert the support pin in the holes at the top of the 10cm downrod and slide the hanger ball up the 10cm downrod. Make sure the support pin is properly seated in the grooves in the top of the hanger ball.
4. Tighten the set screws firmly .

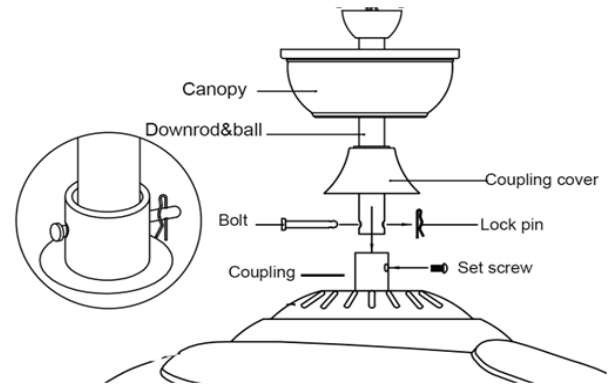

### Safety Cable Installation

For Canadian installation and for USA fan and light kit combinations over 35 lbs, the safety cable must be installed into the house structure beams. Make sure that when the safety cable is fully extended the lead wires are longer than the cable and no stress is placed on the lead wires. Note: If Installing The Secondary Support Safety Cable in the U.S., Do Not Remove Knockouts In The Outlet Box.

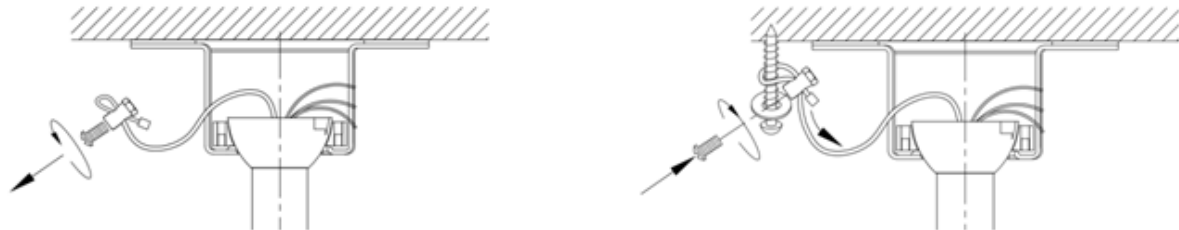

## INSTALLING THE LIGHT KIT

1. Remove the 4 garnish nuts preassembled from the garnish screws on the base plate
2. Remove the plastic protective film from the light shade and route the wires exiting from the bottom of the fan motor through the light shade.
3. Make wiring connections. Please refer to the section 'MAKE THE ELECTRIC CONNECTION' for the electric connection between fan motor and light kit.
4. Attach the light pan onto the base plate. Aligning the 4 holes on the light pan with the 4 preassembled garnish bolts on the base plate. Reinstall the 4 garnish nuts that were removed in step 1. And tighten all nuts and screws securely

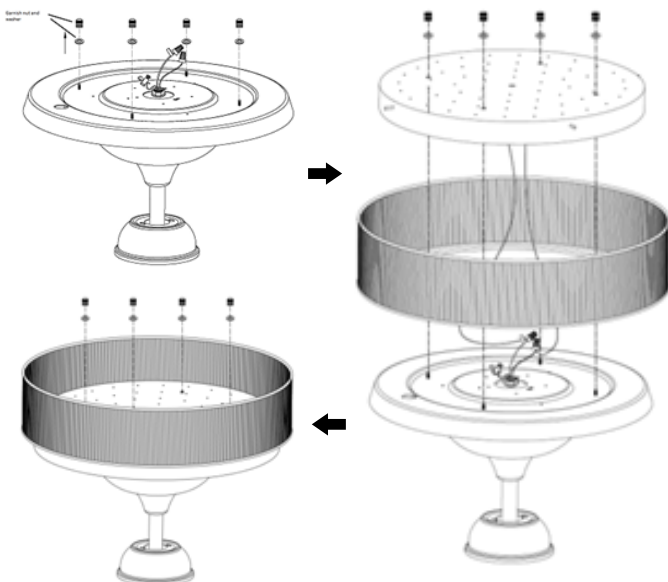

## INSTALLING THE FAN TO MOUNTING BRACKET ON CEILING

5. Install ball end of downrod into mounting bracket opening. Align (engage) slot on ball with tab on mounting bracket. Warning: Failure to align slot on ball with tab may result in serious injury.
6. Slide the canopy up to ceiling and align the keyhole slots on the canopy with the preassembled screws on the hanger bracket. Twist clockwise till lock. Tighten two screws securely.

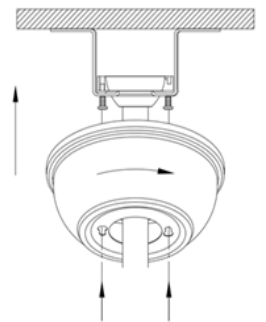

## USING YOUR CEILING FAN

### REMOTE CONTROL

Turn on the power and check the operation of the fan

- .OFF –Fan Shutdown
- .HI, MED, LO – Speed Controlle
- .LIGHT – Lamp switch

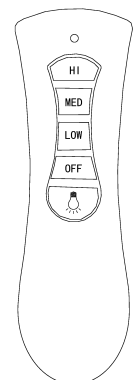

## MAKE THE ELECTRIC CONNECTIONS

**WARNING:** To avoid possible electrical shock, be sure electricity is turned off at the main fuse box before wiring

**NOTE:** Do not connect the motor supply cable to a dimmer switch.

1. Insert the receiver into the mounting bracket with the flat side of the receiver facing the ceiling.
2. Motor to Receiver Electrical Connections: Connect the Black wire from the fan to Black wire from the receiver. Connect the white wire from the fan to the white wire from the receiver. Secure wire connections with the wire nuts provided.
3. Receiver to House supply wires Electrical Connections: Connect the black(hot) wire from the ceiling to the black wire from the receiver. Connect the white(neutral) wire from the ceiling to the white wire from the Receiver. Secure the wire connections with the wire nuts provided.
4. Light kit to motor wires Electrical Connections: Connect the two white wires from light pan to the black and blue wires from fan. Secure the wire connections with the wire nuts provided. provided.

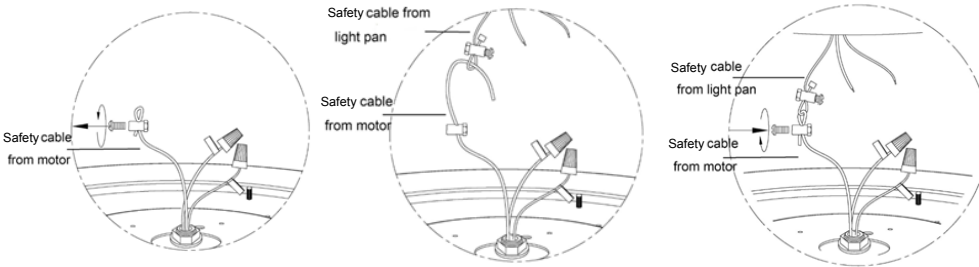
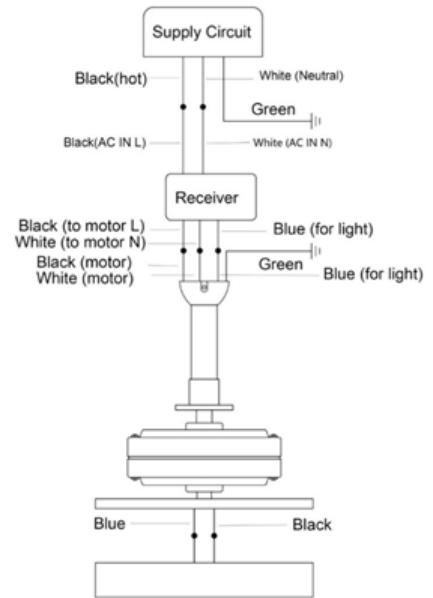

## INSTALLING THE DECORATIVE PENDANTS

You should have below contents for assembly:

5 bags of chains with small crystals in 5 different length, marked with A,B,C,D,E and 61 crystal beads

Please follow the below steps to assemble properly

1. Unpack bag E, take out the chain from the bag (1 pc)
2. Connect the crystal bead to the chain with the clip at the end of the chain.(refer to the below fig)
3. Hang the assembled crystal prism to the light pan with hook on the top of the chain as shown in Fig x. Make sure to hang on the light pan at E point
4. Unpack bag D and take out the chains from the bag(total 6pcs). Repeat Step 2 and 3. Make sure to hang on the light pan at 6 points on the circle D as shown in below Fig
5. Unpack bag C and take out the chains from the bag(total 12pcs). Repeat Step 2 and 3. Make sure to hang on the light pan at 12 points on the circle C as shown in below Fig.
6. Unpack bag B and take out the chains from the bag(total 18pcs). Repeat Step 2 and 3. Make sure to hang on the light pan at 18 points on the circle B as shown in below Fig.
7. Unpack bag A and take out the chains from the bag(total 23pcs). Repeat Step 2 and 3. Make sure to hang on the light pan at 23 points on the circle A as shown in below Fig
8. Double check all connections and make sure all are secured. You light kit is ready for operation.

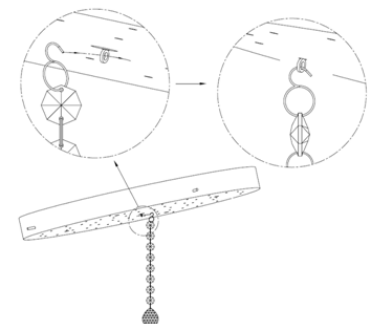
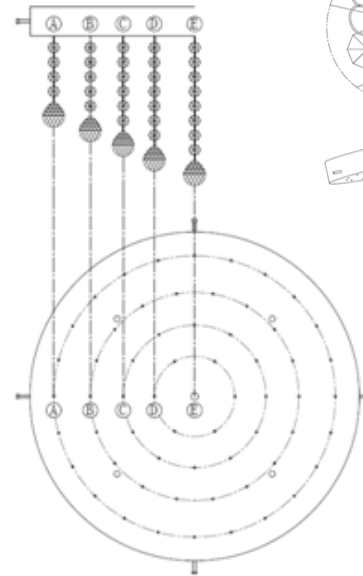
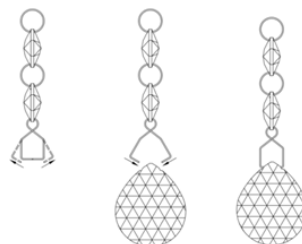

**NOTE: Make sure to hang the crystal prisms in order: E-D-C-B-A**

## AFTER INSTRUCTION

### WOBBLE

The fan blades have been adjusted in the factory to minimize any wobble

**NOTE:CEILING FANS TEND TO MOVE DURING OPERATION DUE TO THE FACT THAT THEY ARE MOUNTED ON A RUBBER CROMMET. IF THE FAN WAS MOUNTED RIGIDLY TO THE CEILING, IT WOULD CAUSE EXCESS VIBRATION. MOVEMENT OF A FEW CENTIMETERS IS QUITE ACCEPTABLE AND DOES NOT SUGGEST ANY PROBLEM**

**TO REDUCE THE FAN WOBBLE: PLEASE CHECK THAT ALL SCREWS WHICH SECURED THE MOUNTING BRACKET AND DOWNROD ARE SECURE.**

**BALANCING A WOBBLING CEILING FAN:**

For your convenience, a Balancing Kit is included; please follow this procedure when balancing the fan:

- 1) Install fan without light dome before balancing the fan.
- 2) Define the base plate into four areas(point A,B,C&D). Use one weight from the balance kit to lightly stick on the edge of the base plate(Point A), if the wobble worsens, then take off the balance kit to lightly stick on the opposite side(Point B); if the wobble is worse,then go to the adjacent point C or D, if the wobble gets better, then securely stick on the weight at this location on the base plate.
- 3) After balancing the fan, assemble the light dome to the light base.

### NOISE

When it is quiet(especially at night) you may hear occasional small noises. Slight power fluctuations and frequency signals superimposed in the electricity for off-peak hot water control,may cause a change in fan motor noise. This is normal. Please allow a 24-hour "breaking-in" period, most noises associated with a new fan disappear during the time. The manufacturer's warranty covers actual faults that may develop and NOT minor complaints such as hearing the motor run – All electric motors are audible to some extent.

### CARE AND CLEANING

1. Periodic cleaning of your ceiling fan is the only maintenance required. Use a soft brush or lint free cloth to avoid scratching the paint finish. Please make sure to turn off electricity power before you maintain your fan
2. Do not use water when cleaning your ceiling fan. It could damage the motor or the blades and create the possibility of an electrical shock.
3. Motor has permanently lubricated ball bearing. No need to oil

**NOTE: MAKE SURE THE POWER IS OFF AT THE ELECTRICAL PANEL BOX BEFORE YOU ATTEMPT ANY CLEANING OR REPAIRS.**

## BEFORE INSTALLATION

Unpack your fan and check the contents. You should have followings:

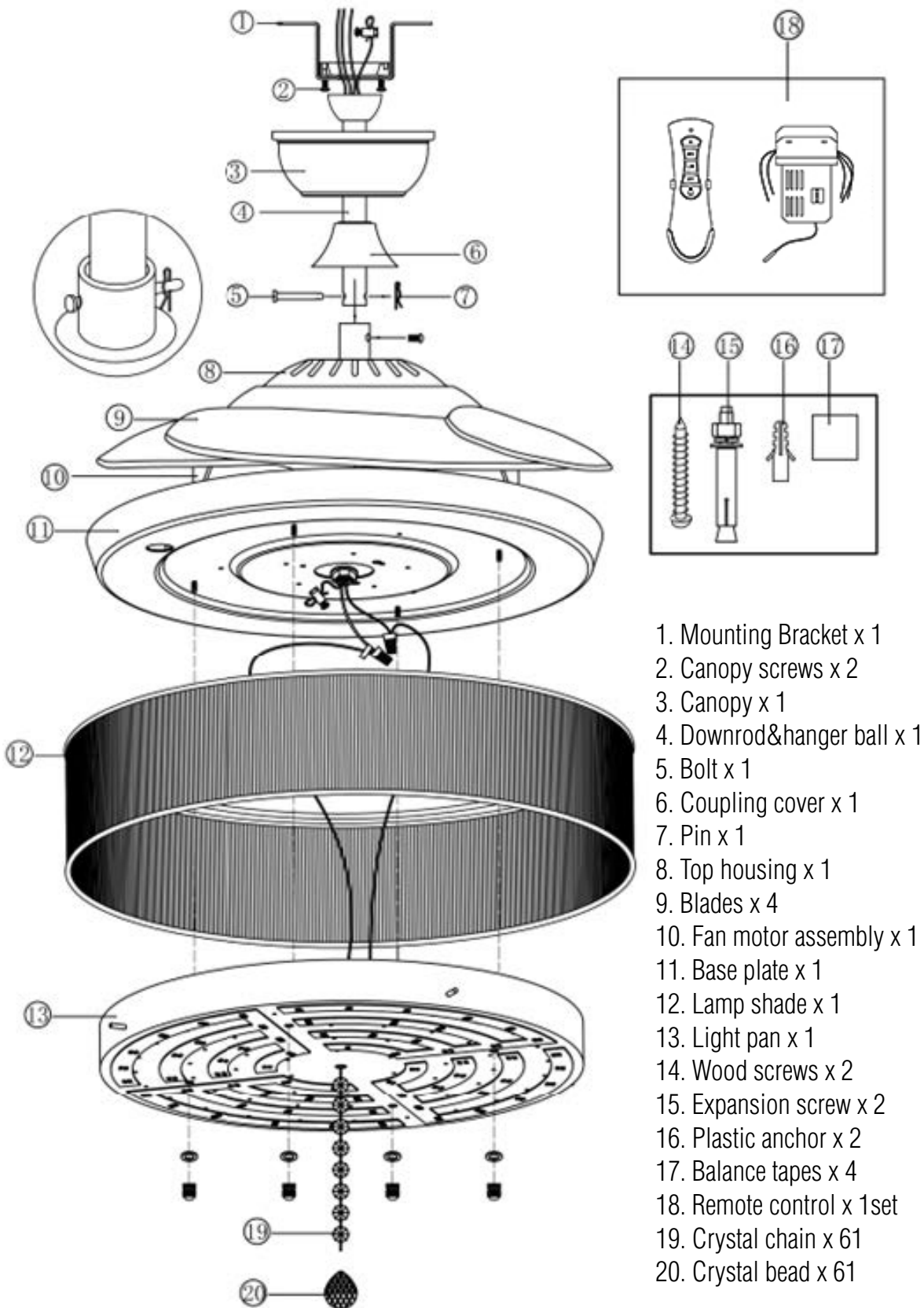

1. Mounting Bracket x 1
2. Canopy screws x 2
3. Canopy x 1
4. Downrod&hanger ball x 1
5. Bolt x 1
6. Coupling cover x 1
7. Pin x 1
8. Top housing x 1
9. Blades x 4
10. Fan motor assembly x 1
11. Base plate x 1
12. Lamp shade x 1
13. Light pan x 1
14. Wood screws x 2
15. Expansion screw x 2
16. Plastic anchor x 2
17. Balance tapes x 4
18. Remote control x 1set
19. Crystal chain x 61
20. Crystal bead x 61