

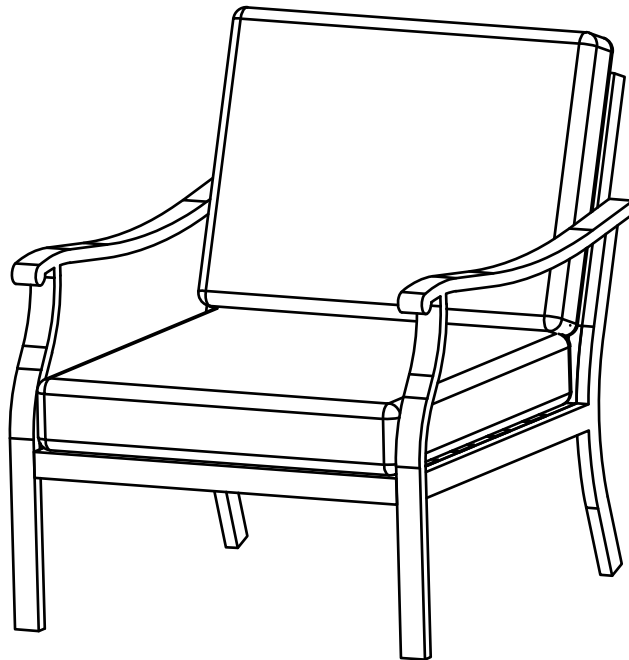

Item # XXXXXX
Model # HD20700
HD20710

USE AND CARE GUIDE

RILEY KD 2-PACK LOUNGE CHAIR



Questions, problems, missing parts?

Before returning to the store, call Hampton Bay Customer Service
8 a.m. - 7 p.m., EST, Monday-Friday, 9 a.m. - 6 p.m., EST, Saturday

1-855-HD-HAMPTON

HAMPTONBAY.COM

Table of Contents

Table of Contents.....	2	Care Instructions.....	2
Safety Information.....	2	Pre-Assembly.....	3
Warranty.....	2	Planning Assembly.....	3
2 Year Frame / Fabric Limited Warranty.....	2	Hardware Included.....	3
What is Covered.....	2	Package Contents.....	4
What is Not Covered.....	2	Assembly.....	5

Important Safety Instructions

SAVE THESE INSTRUCTIONS

 **WARNING:** FUELS USED IN LIQUEFIED PROPANE GAS APPLIANCES, AND THE PRODUCTS OF COMBUSTION OF SUCH FUELS, CAN EXPOSE YOU TO CHEMICALS INCLUDING BENZENE, WHICH IS KNOWN TO THE STATE OF CALIFORNIA TO CAUSE CANCER AND CAUSE BIRTH DEFECTS OR OTHER REPRODUCTIVE HARM. For more information go to: www.P65Warnings.ca.gov.

 **WARNING:** FUELS USED IN WOOD OR CHARCOAL BURNING APPLIANCES, AND THE PRODUCTS OF COMBUSTION OF SUCH FUELS, CAN EXPOSE YOU TO CHEMICALS INCLUDING CARBON BLACK, WHICH IS KNOWN TO THE STATE OF CALIFORNIA TO CAUSE CANCER, AND CARBON MONOXIDE, WHICH IS KNOWN TO THE STATE OF CALIFORNIA TO CAUSE BIRTH DEFECTS OR OTHER REPRODUCTIVE HARM. For more information go to: www.P65Warnings.ca.gov.

READ ALL INSTRUCTIONS BEFORE USE

To reduce the risk of injury to persons:

1. Close supervision is necessary when this furnishing is used by or near children, or disabled persons, if applicable.
2. Use this furnishing only for its intended use as described in these instructions. Do not use attachments not recommended by the manufacturer.
3. This table is not intended to support an umbrella. Umbrellas must have a suitable base or stand.

 **DANGER:** Keep children out of the assembly area before assembly.

 **WARNING:** Do not put heavy objects, sit or stand on the table.

 **IMPORTANT:** Check the tightness of all bolts at least once every 90 days.

Warranty

2 YEAR FRAME / 2 YEAR FABRIC LIMITED WARRANTY

WHAT IS COVERED

We warrant the frame to be free of manufacturing defects to the original purchaser for two years.

WHAT IS NOT COVERED

It remains the customer's responsibility for freight and packaging charges to and from our service center. This warranty does not cover commercial use, hardware, acts of nature, fire, freezing and abusive use. In addition, purchased parts are not covered under this warranty. We reserve the right to make substitutions with similar merchandise, if the model in question is no longer in production.

Care Instructions

Before using, wipe with a clean, dry cloth. Do not use bleach or solvents. Treat the frame with liquid wax for maximum protection against UV light and salty, damp air. When not in use, store furniture in a cool, dry place. If the set includes cushions or mesh fabric, they may be cleaned by hand with a mild solution of soap and water. Rinse cushions thoroughly and allow to drip dry. Do not machine wash or tumble dry, as cushions may shrink. Do not use bleach or solvents on fabrics. When cleaning the tabletop make sure to use a soft, clean cloth that does not bleed color. You may contact our customer service department with any questions by phone at 1-855-HD-HAMPTON or visit www.hamptonbay.com.

Pre-Assembly

PLANNING ASSEMBLY

Assemble this product on a soft, non-abrasive surface to avoid scratching the finish.

HARDWARE INCLUDED



NOTE: Hardware not shown to actual size.

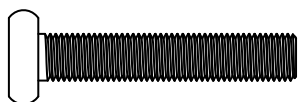

AA



BB



CC



DD

Part	Description	Quantity
AA	Bolt (M6 x 35 mm)	8
BB	Metal Washer (\varnothing 13 *1.0mm)	8
CC	Allen Wrench (M6)	1
DD	Plastic Bolt Cap (M6)	8



CAUTION: IT IS THE USER'S RESPONSIBILITY TO MAKE SURE ALL PARTS ARE ASSEMBLED AND TIGHTENED PROPERLY AND SECURELY.

Pre-Assembly (continued)

PACKAGE CONTENTS

CHAIR FRAME

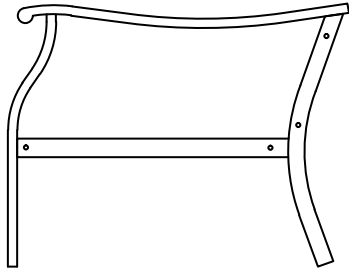

A

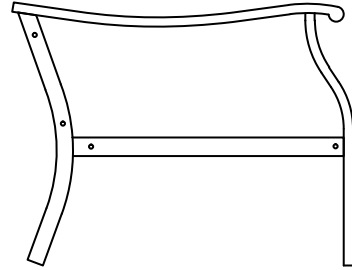

B

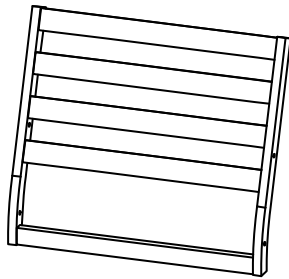

C

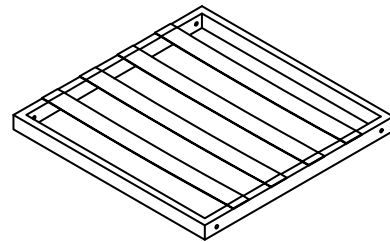

D

CUSHIONS

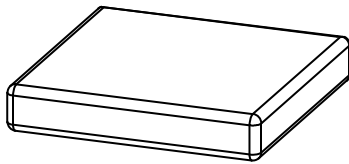

E

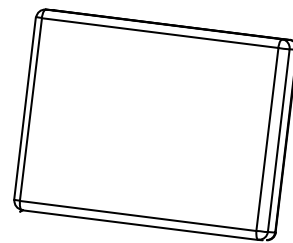

F





Part	Description	Quantity
A	Right Armed Chair	1
B	Left Armed Chair	1
C	Back	1
D	Seat	1
E	Seat Cushion	1
F	Back Cushion	1

Assembly

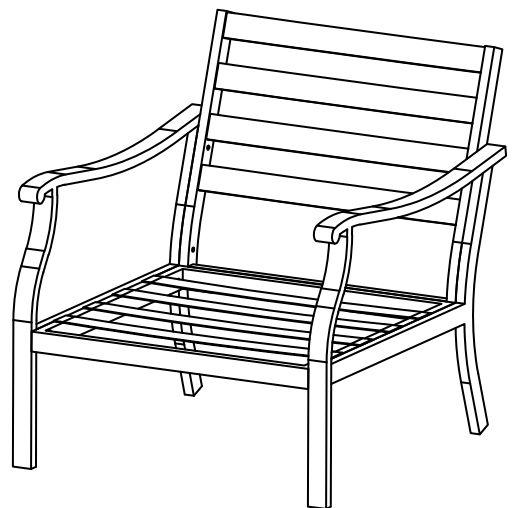
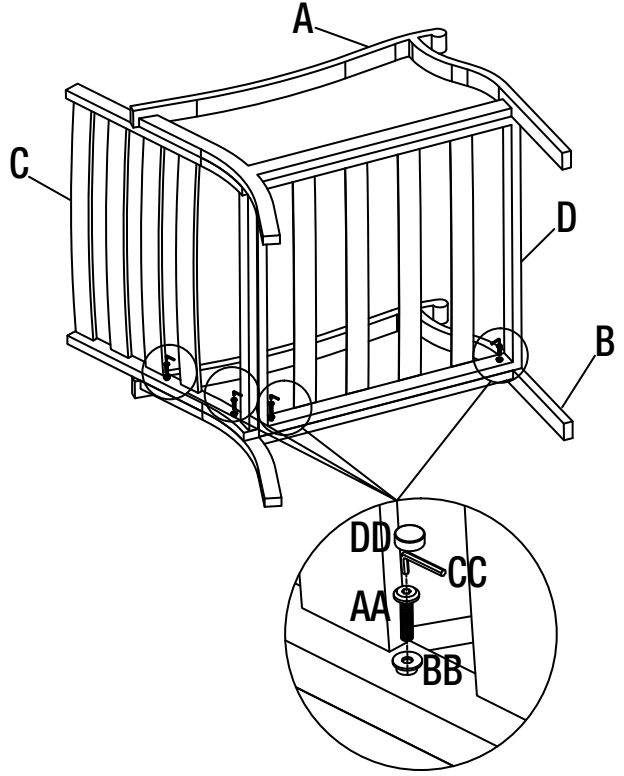
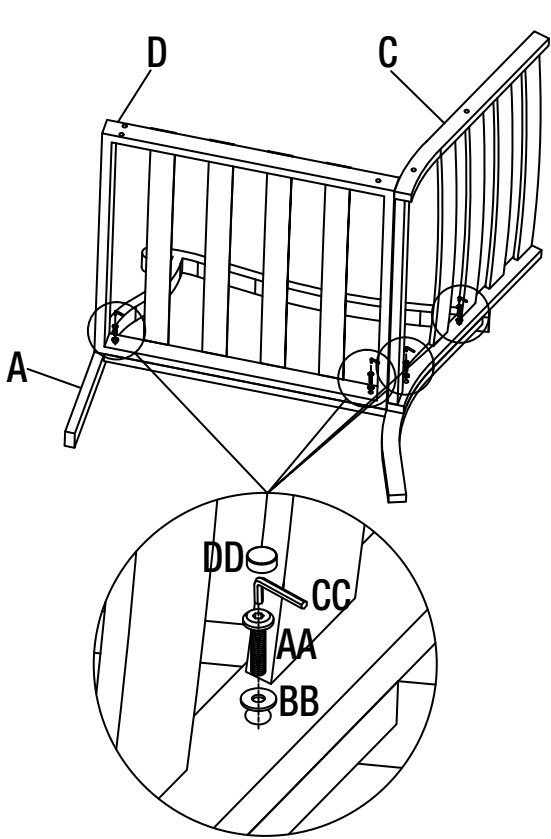
1

- Attach Right Arm to Back at two points and to Seat at three points with hardware as shown in Diagram 1.
- Attach Left Arm to Back at two points and to Seat at three points with hardware as shown in Diagram 2.



Part	Description		Quantity
AA	Bolt (M6 x 35 mm)		8
BB	Metal Washer (Ø13 *1.0mm)		8
CC	Allen Wrench (M6)		1
DD	Plastic Bolt Cap (M6)		8

2

- After finishing chair assembly, place back and seat cushions onto chair. Your furniture is now ready for use, so relax & enjoy.

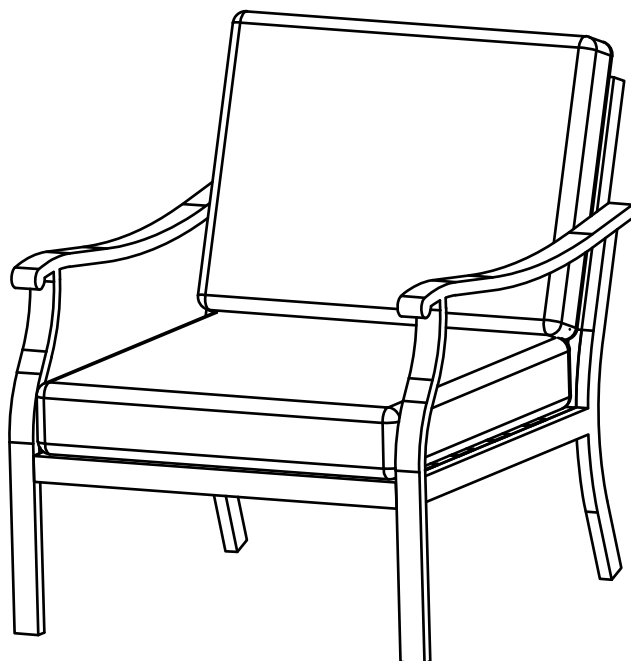



Questions, problems, missing parts?

Before returning to the store, call Hampton Bay Customer Service
8 a.m. - 7 p.m., EST, Monday-Friday, 9 a.m. - 6 p.m., EST, Saturday

1-855-HD-HAMPTON

HAMPTONBAY.COM

Retain this manual for future use.

THANK YOU

We appreciate the trust and confidence you have placed in Hampton Bay through the purchase of this table. We strive to continually create quality products designed to enhance your home.

Visit us online to see our full line of products available for your home improvement needs.

Thank you for choosing Hampton Bay!