

Brio[®]

USER'S MANUAL

Point of Use
Water Cooler

MODEL NO.
CLPOUROSC420

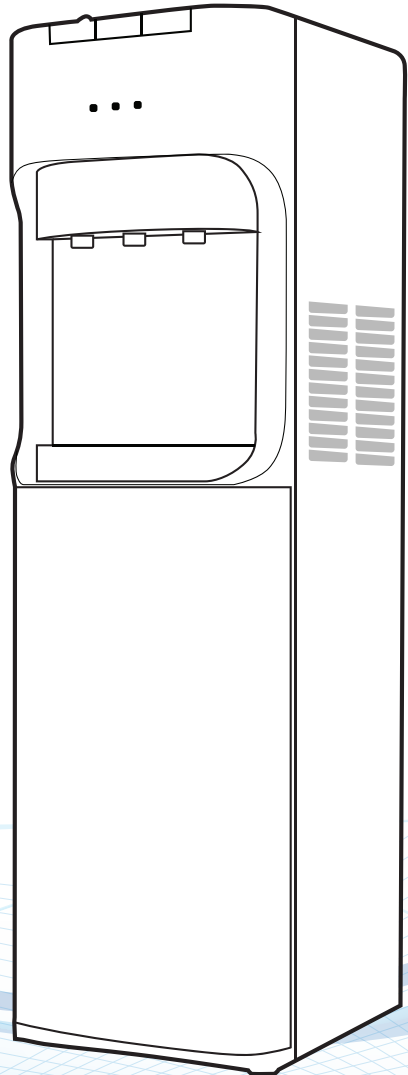

Thank you for purchasing a Brio water cooler.
Please read this user's manual thoroughly for
using the water coolers safely and appropriately.



HOT, ROOM & COLD



POINT OF USE



ENERGY STAR



UL LISTED



Intertek



Intertek

NSF / ANSI 372

SAFETY PRECAUTIONS

- Plug in the dispenser in the way described in this manual.
- In accordance with these instructions, the dispenser must be properly located and installed before use
- Use only water. Do not use coffee, tea or other beverages.
- Dispenser must be unplugged before cleaning, sanitizing or repairing. Regular cleaning is advised to ensure satisfactory water quality.
- Always unplug the dispenser power cord before servicing or filter replacement.
- Do not use with water that is microbiologically unsafe or of unknown quality.
- periodically remove dirt and lint from the condenser on the back of the cooler.

WARNING: The hot water is heated to approximately 90°C (194°F). Temperatures above 52°C (125°F) can cause severe burns from scalding. **DO NOT ALLOW CHILDREN TO USE THE HOT WATER DISPENSING BUTTON WITHOUT PROPER AND DIRECT SUPERVISION.**

- Ensure the dispenser stands upright for 2 hours before loading water bottle, plugging in or turning the unit on.
- Always lift dispenser by handle located on rear of unit. **DO NOT** Lift dispenser by the faucets, this part of the cooler may break and cause leaks if pulled by force.
- Supervise children when using the dispenser; water from hot faucet will be extremely hot and may scald.
- The recommended placement of the water dispenser is indoors. Keep away from direct sunlight and excessive moisture

WARNING: The dispenser must be grounded – if the appliance is improperly grounded, it may result in an electric shock

IMPORTANT: To provide additional protection from the risk of shock, the dispenser **MUST** be connected to a ground fault circuit interrupter (GFCI) outlet at all times. Use of an extension cord will void any warranties. See warranty document for complete terms and conditions.

Cautions

- Do not connect the dispenser to the power outlet yet. Install the dispenser on a flat and secure place approximately 4 inches (10cm) from the wall.
- If you need to move the dispenser, wait approximately 1 hour after turning off the power. Upon moving, do not tilt the dispenser more than 45 degrees.
- Make sure that the electric socket is correctly grounded to prevent electric shock.
- Check If the Water Levers are firmly closed.
- This dispenser is intended for indoor use only.
- Do not expose to direct sunlight.

INSTALL TEE FITTING

- 1) Turn off the cold water supply to the sink.
- 2) Turn on the kitchen faucet to release pressure and allow water to drain from the line.
- 3) Disconnect the cold water line from the threaded stem on the bottom of the kitchen faucet. Attach threaded ends of supplied brass tee to the cold water supply line and shut-off valve; tighten using an adjustable wrench.
- 4) Attach 1/4" tube to the tee:

Push the tubing into the quick connect fitting, then gently pull back on the tubing to make sure the connection was secure.

To Disconnect: Push in and hold down on the collet ring square against the fitting. With the collet held in this position the tube can be removed.

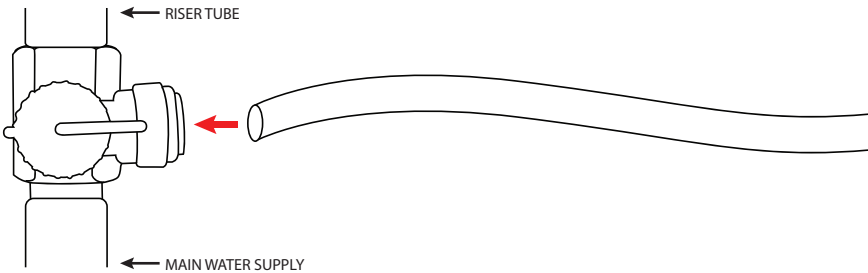

- 5) Do not connect the other end at this time.

CONNECTING THE SYSTEM

How to Connect: - Push the tubing into the quick connect fitting, then gently pull back on the tubing to make sure the connection was secure.
- No inserts, sleeve, or nuts are needed to secure the connection.
- No Teflon tape!

To Disconnect: - Push in and hold down on the collet ring square against the fitting. With the collet held in this position the tube can be removed.



I: Tee to Connection Port Labeled "IN"

Take the tubing leading from the tee and insert it into the manifold port indicated by the label "IN". Remember to push it all the way until it stops.

II: Tee to Connection Port Labeled "OUT"

Take the tubing leading from the tee and insert it into the manifold port indicated by the label "OUT". Remember to push it all the way until it stops.

INSTALL RO DRAIN CONNECTOR

	⚠ WARNING Be sure that all electrical appliances and outlets are turned off at the circuit breaker before working in the cabinet area.		⚠ CAUTION Please wear safety glasses to protect eyes when drilling.
---	--	---	---

Note: To avoid possible drainage noise, mount drain line as low as possible on the vertical tailpiece, or on horizontal tailpiece.

1. Identify drain outlet location.
2. Remove protective cover from back of foam seal.
3. Knock center hole out, align holes, and attach to front plate of drain connector.
4. Allowing room for drilling, position the drain connector on sink drain pipe above drain trap.
5. Securely tighten nuts and screws.
6. Using drain connector port as drill guide, drill 7/32" hole through wall of drain pipe. Be sure not to penetrate opposite side of pipe, and be careful not to damage side of drain port fitting.

Make sure to align the drain saddle hole to the drilled hole perfectly. Mis-aligning these two holes will block the waste water and cause membrane damage. Attach the drain saddle to the drain pipe and tighten the two screws evenly.

Push the tubing into the Quick Connect fitting, then gently pull back on the tubing to make sure the connection was secure.

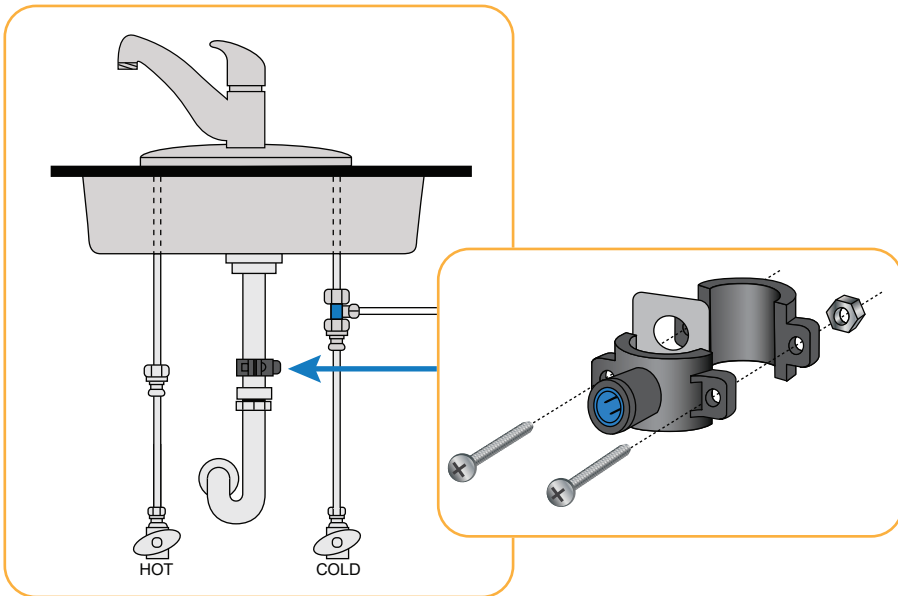

Working with your home's plumbing system can be unsafe and difficult to do correctly without the proper training. Also, your system will need to be connected to piping in a relatively cramped space (behind and underneath your sink) and it can be especially difficult to adequately tighten plumbing connections in that small space without the know-how and specific tools.

⚠ Proper installation is the responsibility of the installer.

⚠ Product failure due to improper installation is not covered under the warranty.

System Start Up

1. Turn on feed water: Slowly, turn on your Cold water supply. Open the Tee Valve (turn counter-clockwise) to allow the raw water to enter the system. Check for leaks!
2. Wait for tank to fill: Before usage, allow the tank to fill. Tank normally takes 15 to 30 minutes to fill. When the tank is filled, the RO will shut off automatically.
4. Drain Tank: Do not use the first tank of water! Drain it out to flush the system and new filters. Press down the hot and cold buttons to drain the water out. Let the tank refill again and the pure water is ready for use.
5. Clean up area: Allow the system to run while cleaning up tools and work area.
6. Check for leaks! Make sure no leaking at joints, fittings, valves, and tubing connections.

PP sediment filter	C1 active carbon filter	RO reverse osmosis filter	C2 active carbon filter
6 months	6 months	24 months	12 months



Cautions

When you use water with unsafe or unknown quality, we recommend you to use a filter because it can cause product failures.

■ Filter Replacement

1. Unplug power cord.
2. Shut off the water flow by turning the lever on the straighty valve to close.
3. Replace all the filters needed. Place a towel under the filter to catch excess water that drips out from the filter during changeover.
4. Once you have replaced all the filters needed, turn the lever on the straight valve to open water flow.

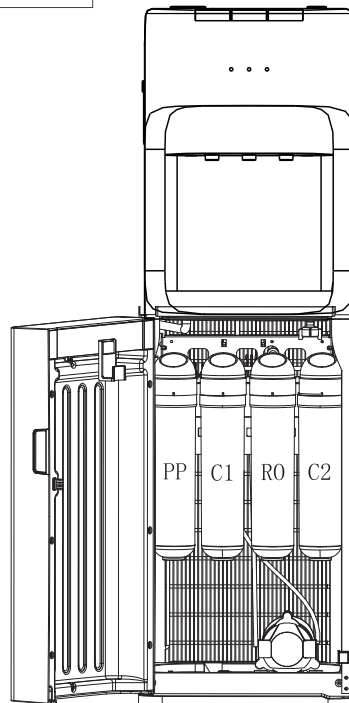

Remove the Air inside the Hot Water Tank

After installing the filter, remove the air inside the Hot Water Tank by pressing and holding the Hot Water Lever as shown in the following figure until water starts to come out of the water outlet.

Place a cup under the hot dispenser faucet. Squeeze the front and back of the left faucet handle together and push down until water flows continuously. Depress the cold water faucet to make sure there is a continuous flow of water

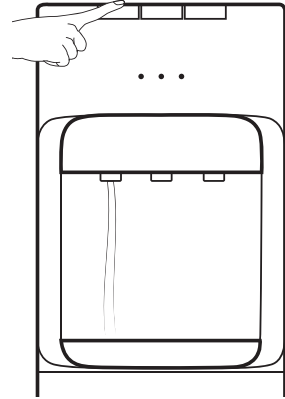

Case / Drip Tray

Case: Clean the dispenser using a soft damp cloth. At all times, do not use abrasive cleaning materials or implements.

Once the soiled parts of the dispenser have been cleaned, dry by using a soft cloth.

Drip Tray: Clean the Drip Tray and then wipe off with a neutral detergent and a soft cloth.

Radiator Condenser

A radiator is mounted on the back of Dispenser. If it is too close to a wall, or when the radiator gets covered in dust, the cooling efficiency will be impaired. Please clean the dust off with a soft brush or vacuum cleaner. This should be done regularly.

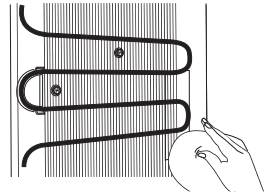

Check the Power Cord / Plug

Check to see that the power cord is not damaged or overheating, and also that no heavy objects are placed on it. Failure of the power cord could lead to fire or shock hazards. Please frequently check.

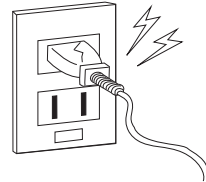

Check the Leakage

If the filter is not installed properly, or when the Drain Cork is not closed completely, leakage may occur. Check if there are any leakages on the back or bottom by moving the dispenser.

Leakage of Tank

If there are any leakages, drain the Cold Water through Water outlet.

Drain the hot water by removing the cap of Hot Water Drain Valve.

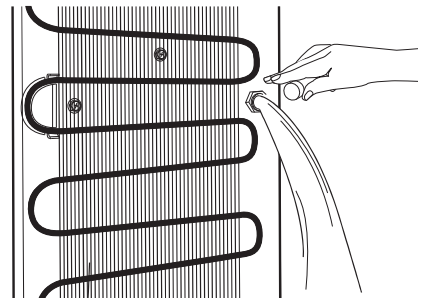

Cautions

Before draining hot water, wait one hour after turning power off to allow water to cool down. Otherwise, you may be burnt by hot water.

■ Hot, Cold, & Room Faucets

Press the button on the right for Cold Water, middle for room temperature water, & left button for hot water. Place a cup directly below a faucet and depress the correct lever, but be careful using the hot water. Even when a bottle is empty, Cold Water is available, for a small volume, but hot water is not available when the bottle is empty.

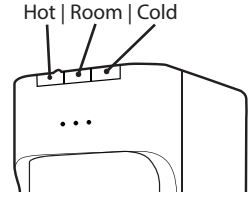

How to use Child Lock Lever

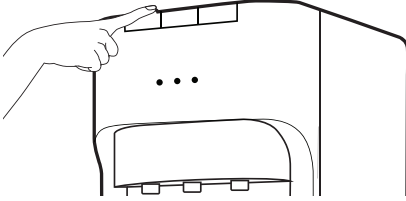

Hot water comes out if pressing down the lever with the safety lock pressed in.

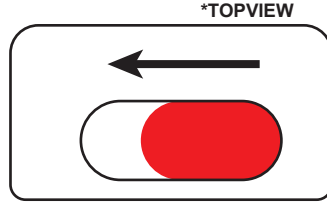

push in safety button to unlock, then push down to dispense hot water



Cautions

When the hot water comes out, be careful not to burn yourself. Do not allow the children to use the dispenser unsupervised.

RECEIVING

Inspect the dispenser box carefully for any evidence of shipping or handling damage before signing to receive goods. In case of shipping damage, claims should be filed immediately with the carrier

HOW TO INSTALL AND USE

1. Keep cooler unplugged until water flows all the way through faucets
2. Ensure dispenser stands upright for a minimum of 2 hours before loading water bottle.
3. Place dispenser a minimum of 4 inches away from the wall to ensure ventilation.
4. Install dispenser on a level floor strong enough to support it when fully loaded.
5. Do not install dispenser where it will be subject to direct sunlight, heat or moisture.

1.Flowchart of water generation

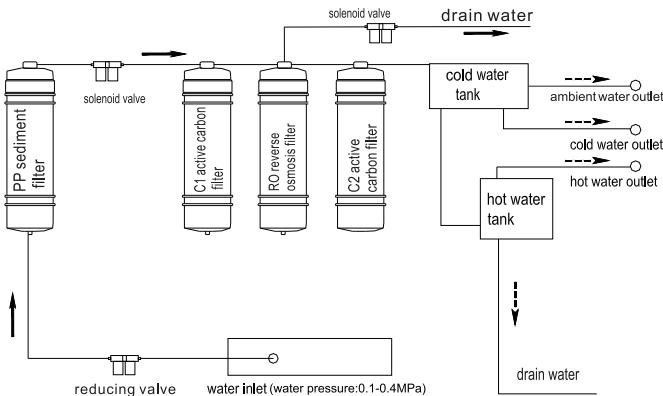

2.Circuit diagram

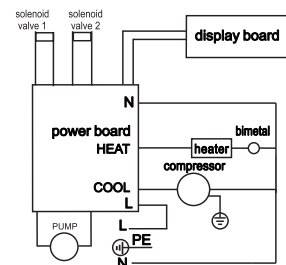

■ Cleaning the POU cooler

1. Disconnect power cord from outlet.
2. Remove top of cooler and inner float assembly to expose the cold tank below.
3. Drain reservoir through the cold water (light blue) faucet and the hot water (red if you have a hot and cold water cooler) faucet into a bucket and throw that away. If there is ice in the reservoir, allow to melt and then drain. You can add hot water to speed up the melting. If you have a hot & cold water cooler, then drain the hot tank via the plug on back of water cooler.
4. Clean cooler exterior & faucets with hot water and mild soap. Dry with paper towels.
5. Remove the water guard or spill-free top from your water cooler. Remove the baffle inside the reservoir as well. Both should just pull right out, depending upon the model cooler you have. Also remove (by unscrewing) the spigots on the front of the water cooler. If you have a removable reservoir water cooler then you can also take that out at this time.
6. Wash these with mild dish soap and water. Rinse with clean water and set aside. If you removed the reservoir then reinstall that first. Screw the faucets back on to the front of the water cooler.

■ Cleaning the POU cooler reservoir

1. For hot & cold water coolers you must plug the hot tank off. You can do this with a small cork or plug. It must be tight and fit right in the center hole in the bottom of the water cooler's reservoir. This prevents the sanitizer from getting into your hot tank -- if bleach gets into the hot tank, your hot water will taste like chlorine for quite a while. The hot tank sanitizes itself since it's very hot.
2. mix one gallon of clean water and one teaspoon of unscented bleach. Put on your clean rubber gloves and dip a clean, lint-free towel into the solution and wring out the excess liquid. Towel down clean all of interior surfaces of the reservoir thoroughly. Let that chlorine solution stay in the cooler for about 5 minutes.
3. Sanitize spill-free top and baffle by wiping them down with the towel filled with the sanitizing solution. You don't need to soak them, just wipe them. Allow to sit for at least 3 minutes and then rinse thoroughly with clean bottled water, and set aside.
4. Fill reservoir full of fresh bottled water and completely drain that water through the cold faucet. Repeat twice. That makes three (3) times total, and uses about three (3) gallons of bottled water.
5. Put on a clean pair of rubber gloves and take out the hot tank cork (if you put one in), replace the baffle and spill-free top assembly by pressing them firmly back into place. You shouldn't have any chlorine taste. If you do, keep draining more water until the chlorine taste disappears.
6. Plug the cooler back in. It might take thirty minutes or so before the water is hot and/or cold again.

TROUBLESHOOTING

Please check the following items prior to asking for repair

Troubles	Things to check	Troubleshooting
Water does not come out (Cold Water & Hot Water)	Water shut-off valves.	Open all water shut-off valves.
	Is the air inside the Tank removed completely?	Press and hold the lever until the water comes out through Hot Water Faucet.
Cold water does not come out	Is the power cord unplugged?	Check the power cord.
	Is the power appropriately supplied? Has the circuit breaker tripped?	Check the Distribution board.
	Is the capacity for producing cold water exceeded by your demand? Is the remaining cooling time too short?	Reduce consumption to within capacity specified for the dispenser.
	Is the temperature too high?	Install in a place where the air is well circulated. Do not expose to direct sun light.
	Are there dust on the radiator condenser?	Clean the radiator condenser mounted on the back.
	Is the back of the dispenser too close to a wall?	Install with 15cm separated from a wall. Reinstall to allow the radiator condenser to be cooled down.
Hot water does not come out	Is the power cord unplugged?	Check the power cord.
	Is the power off? Is Circuit Breaker closed?	Check the plug board.
	Is the capacity for producing hot water exceeded by your demand?	Reduce consumption to within capacity specified for the dispenser.
	Is hot water switch turned off?	Turn on Hot Water Switch mounted on the back.
Dispenser is leaking	Is either the Hot or Cold faucet leaking?	If the faucets are loose, firmly fasten them.
	Is the Hot Water Drain leaking?	Firmly fasten the cap of Hot Water Drain.
	All water line connections.	Make sure blue locking "C" clips are installed on water lines.
	Filter not properly secured and locked?	Secure filter and lock
	Drain cap and plug are not secure.	Ensure drain plug is secure and tighten drain cap.
Noise	Is the dispenser making a vibrating noise?	Make sure that it is installed on a level solid horizontal surface.
	Is the dispenser in contact with a wall or other products?	Keep the designated space away from a wall or other products.

Repair & After Sales Service

Unplug the power cord and then contact our representative from whom you purchased the dispenser.

● Please inform us of following information ●

- (1) Name (Company Name) and Address
- (2) How to contact the staff in charge of the dispenser
- (3) Details of problems encountered.

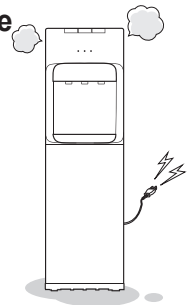

COOLER, PARTS AND ACCESSORIES

Names of Each Component

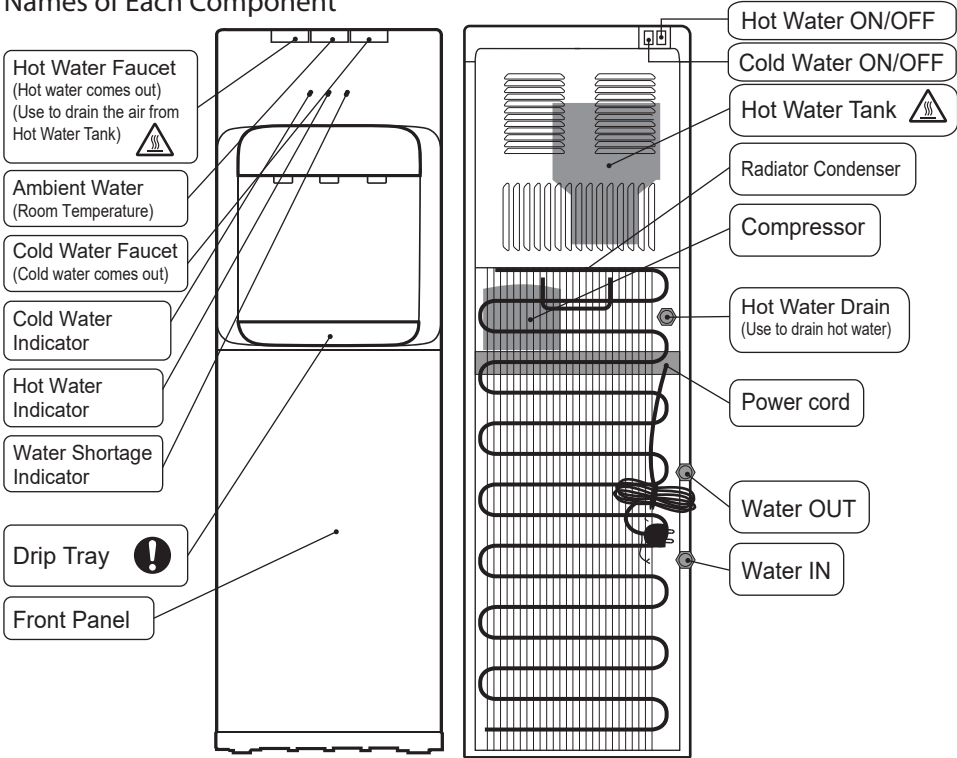

SPECIFICATIONS

Name	Hot, Cold & Ambient Water Dispenser	
Model Number	CLPOUROSC420	
Size	12.2"(W) x 14.2"(D) x 41"(H)	
Net Weight	36.4 LBS	
Gross Weight	40.8 LBS	
Power	115V 60Hz	
Consumption Power	420W/Heating, 100W/cooling	
Cool Water	Cold Water Capacity	2ℓ/H
	Temperature	5°C ~ 10°C
	Tank Capacity	About 3.6ℓ (Stainless Steel Tank)
Hot Water	Hot Water Capacity	4ℓ/H
	Temperature	85°C ~ 95°C
	Tank Capacity	About 1.1ℓ (Stainless Steel Tank)

* For the improvement of product Brio reserves the right to change specifications without notice.

* You must confirm the correct voltage(V) and frequency(Hz) and then plug to the outlet. Check the proper voltage in the back of dispenser.
Manufactured by: DOWNTOWN WHOLESALERS