

INSTALLATION INSTRUCTIONS

CHOOSE THE PROPER LOCATION FLOORING

⚠ WARNING

- Two or more people are required when moving, unpacking, and stacking the washer. Failure to follow this warning may result in damage to property or serious bodily harm.
- Store and install the washer where it will not be exposed to weather or to temperatures below freezing. Failure to follow this warning can cause serious injury, fire, electric shock, or death.
- Properly ground the washer to conform with all electric governing codes and ordinances. Failure to follow this warning can cause serious injury, fire, electric shock, or death.
- To reduce the risk of electric shock, do not install the washer in humid spaces. Failure to follow this warning can cause serious injury, fire, electric shock, or death.
- To ensure proper air flow, do not block the large opening on the bottom of the washer with carpeting or other materials.
- Do not remove the ground prong. Do not use a 2-prong adapter or 2-wire extension cord. Failure to follow these warnings can cause serious injury, fire, electric shock, or death.

⚠ CAUTION

- This pedestal washer must be installed underneath a matching front-loading LG washing machine manufactured after 2009. (The 29" wide machine must be stacked under a 29" wide LG front-loading washer. The 27" wide machine must be stacked under a 27" wide LG front-loading washer.)
- The pedestal washer will not work as a standalone unit.
- The pedestal washer must be stacked under an LG brand appliance in order to operate properly.

POWER OUTLET

- The power outlet must be within 60 in. (1.5 m) of either side of the washer.
- The appliance and outlet must be positioned so that the plug is easily accessible.

⚠ WARNING

- For best performance, plug the washer into its own individual outlet. If necessary, use a new, UL-listed 3-prong adapter or 3-wire extension cord with a 3-prong (grounding) plug rated at no less than the branch circuit. Do not use an extension cord longer than three feet. Failure to follow these warnings can result in serious injury, fire, electric shock, or death
- The outlet must be grounded in accordance with current wiring electric codes and regulations.
- Time-delay fuse or circuit breaker is recommended.

NOTE: It is the personal responsibility and obligation of the product owner to have a proper outlet installed by a qualified service technician.

- To minimize noise and vibration, the washer **MUST** be installed on a solidly constructed floor.
- Allowable slope under the entire washer is a maximum 1 inch. difference from side to side or from front to back.
- Installing on carpeting and soft tile surfaces is not recommended.
- Never install the washer on a platform or weakly supported structure.

NOTE: The washer must be installed on firm flooring to minimize vibration during the spin cycle. Concrete flooring is best, but a wood floor is sufficient, provided it is built to FHA standards. The washer should not be installed on rugs or exposed to weather.

Do not use a drip pan as it can block the drawer. Using the drip pan may result in increased vibration and noise during operation.

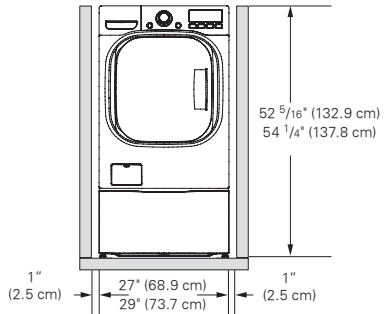

To ensure sufficient clearance for water lines and airflow, allow minimum clearances of at least 1 in. (2.5 cm) at the sides and 4 in. (10 cm) behind the unit. Be sure to allow for wall, door, or floor moldings that may increase the required clearances.

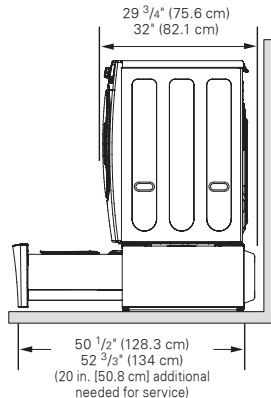

UNPACKING AND REMOVING SHIPPING MATERIAL

1. After removing the carton and shipping material, lift the washer off the foam base. Make sure the plastic tub support comes off with the base and is not stuck to the bottom of the washer.

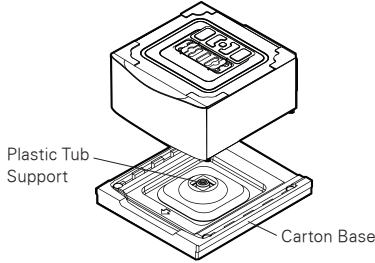

If you must lay the washer down to remove the base packaging materials, always protect the side of the washer and lay it carefully on its side. **DO NOT** lay the washer on its front or back.

2. Save the foam block for future use. If the washer must be moved in the future, the foam block will help prevent damage to the washer during transportation.

NOTE: To prevent damage, do not remove the foam block until the washer is at the final location.

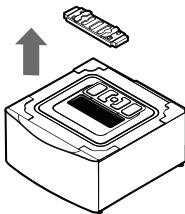

3. Turn the top cover about 180 degrees. Cover the upper hole with the top cover and install 4 short screws (included in packing box) to fix it in place.

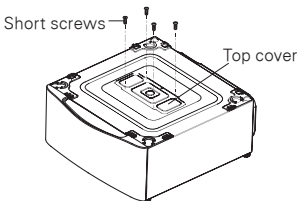

4. Make sure the leveling legs on the front-loading washer are fully retracted before stacking it on top of the pedestal washer. Position the appliance on top of the pedestal washer.

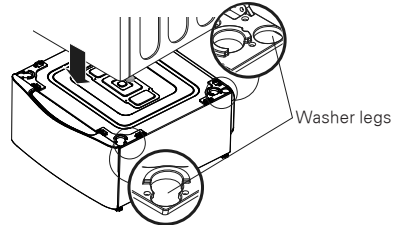

5. Make sure the holes on the pedestal washer align with the holes in the front-loading washer, then install 4 long screws (included in box) at each corner to securely attach the front-loading washer to the pedestal washer.

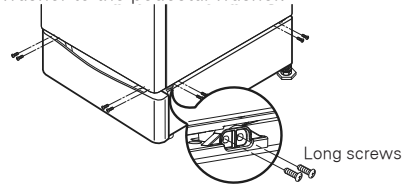

6. Extend the legs of the front-loading washer slightly until it is snugged up against the pedestal washer.

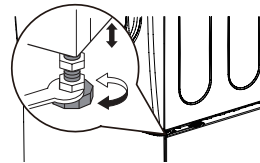

TOOLS YOU WILL NEED

- Adjustable Pliers
- Carpenter's Level

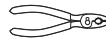

- Screwdriver

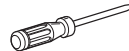

⚠ WARNING

- The top cover must be installed to avoid the risk of electric shock or short circuit. Failure to do so can cause serious injury, fire, electric shock or death.

OVERVIEW OF CONNECTIONS

CONNECTING THE WATER LINES WITH FULL-SIZE APPLIANCES

1. Front-loading washer and pedestal washer with dryer.

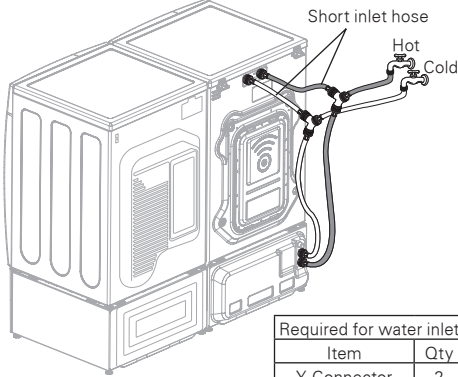

Required for water inlet	
Item	Qty
Y-Connector	2
Short inlet hose	2
Long inlet hose	4

long inlet hoses sold separately

2. Front-loading washer and pedestal washer with Turbo Steam dryer

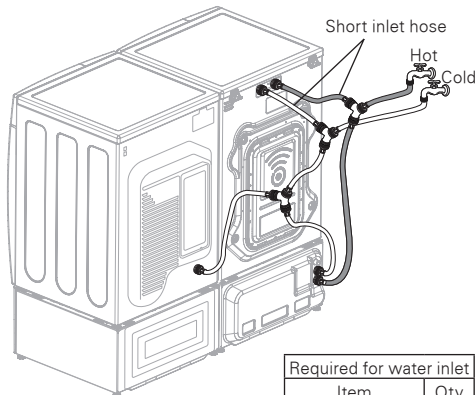

Required for water inlet	
Item	Qty
Y-Connector	3
Short inlet hose	3
Long inlet hose	5

long inlet hoses sold separately

CONNECTING THE DRAIN HOSE WITH FULL-SIZE WASHER

1. Front-loading washer and pedestal washer with dryer.

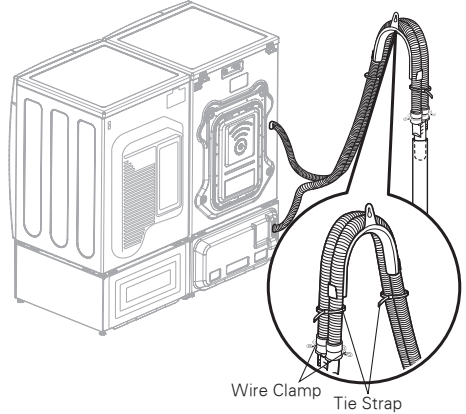

2. Front-loading washer and pedestal washer with hybrid dryer

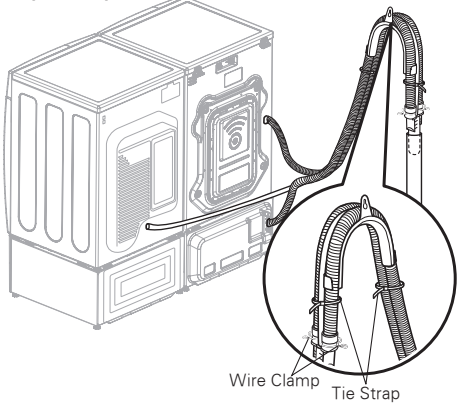

DETAIL VIEW OF DRAIN CONNECTOR CONNECTION

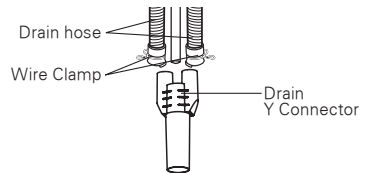

For narrow standpipes, insert hybrid dryer drain hose in center of drain connector. DO NOT insert dryer drain hose further than 1 inch (2.5 cm). Use tie straps to keep hoses in place.

CONNECTING THE WATER LINES

NOTE:

- For your safety, and for extended product life, use high-quality LG components. LG is not responsible for product malfunction or damage caused by the use of separately purchased non-LG parts.
- Do not reuse old hoses. Use only new hoses when installing the washing machine. Old hoses could leak or burst causing flooding and property damage. Contact LG Customer Service for assistance in buying hoses: 1-800-243-0000.
- Do not use flood-preventing hoses with auto shutoff devices. The devices can be tripped during fill and prevent the machine from filling properly.

1. Check the fittings and seals.

Inspect the threaded fitting on each hose and make sure there is a rubber seal in place in both ends of each hose to prevent leaking.

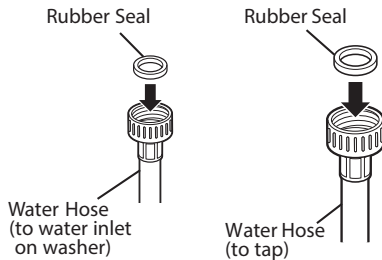

2. Connect the water supply hoses.

Connect the water supply hoses to the HOT and COLD water faucets tightly by hand and then tighten another 2/3 turn with pliers. Connect the blue hose to a cold water faucet and the red hose to a hot water faucet.

⚠ WARNING

- **Do not overtighten.** Damage to the coupling can result.

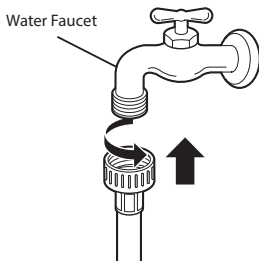

3. Flush out the inlet hoses.

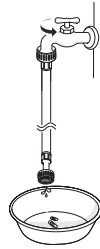

After connecting the inlet hoses to the water faucets, turn on the water faucets to flush out foreign substances (dirt, sand or sawdust) in the water lines. Let water drain into a bucket, and check the water temperature to make sure you've connected the hoses to the correct faucets.

4. Attach the water lines to the back of the washer.

Attach the hot water line to the provided inlet Y-connector and attach the short water line from the Y-connector to the full-size washer inlet. Then attach the long water line from the Y-connector to the pedestal washer inlet. Repeat with the cold water connections.

Tighten the fittings securely. Turn on both faucets all the way and check for leaks at both ends of the hoses.

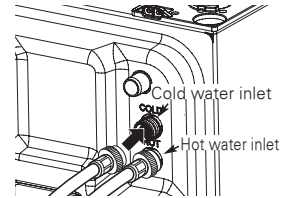

⚠ WARNING

- **Do not overtighten the hoses or crossthread the hose fittings.** Overtightening or cross-threading can damage the valves, resulting in leaking and property damage.

NOTE:

- Periodically check the hoses for cracks, leaks, and wear, and replace the hoses every five years. Do not stretch the water hoses intentionally, and make sure that they are not pinched, crushed or kinked by other objects.
- Water supply pressure must be between 20 psi and 120 psi (138–827 kPa). If the water supply pressure is more than 120 psi, a pressure reducing valve must be installed.
- To provide optimum washing performance, set the hot water temperature at 120°–135°F (48°–57°C) and the cold at 60°F (15°C).
- Never install or store the washer in a location subject to freezing temperatures. Damage to the water lines and internal mechanisms of the washer can result. If the washer was exposed to freezing temperatures prior to installation, allow it to stand at room temperature for several hours before use and check for leaks prior to operation.

CONNECTING THE DRAIN HOSE

- The drain hose should always be properly secured. Failure to properly secure the drain hose can result in flooding and property damage.
- The drain must be installed in accordance with any applicable local codes and regulations.
- Make sure that the drain hose is not stretched, pinched, crushed, or kinked.

CONNECTING THE PEDESTAL WASHER DRAIN HOSE

1. Insert the band clamp (included in packing box) on to the drain hose elbow.

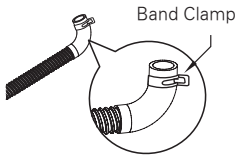

2. With the hose leading up from the elbow, insert the elbow onto the drain outlet on the back of the pedestal washer.

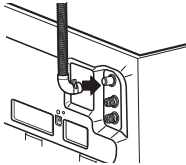

3. Adjust the band clamp with pliers to keep the hose securely in place and prevent leaking.

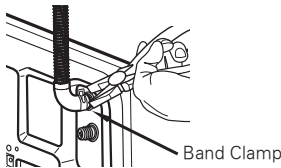

USING THE DRAIN CONNECTOR

- Connect the drain hose of the full-size washer and the pedestal washer to the drain connector. Insert the included wire hose clamps on to the ends of the two drain hoses. Push the drain hoses firmly onto the drain connector. Adjust the wire hose clamps to prevent the hoses from coming loose or leaking. Failure to do so could result in flooding. Use of the drain connector helps avoid siphoning, odors, or improper draining.

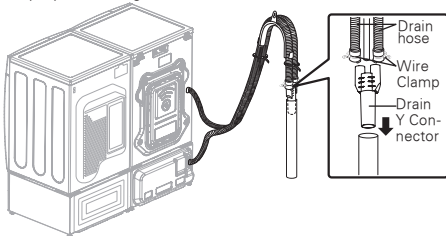

OPTION 1: STANDPIPE

Bend the outlet end of the drain hoses to form a U shape. Insert the end of the drain connector into the drain. Use the three tie straps included with the installation materials in the foam block in the tub to secure the drain hoses to each other and to the drain. See Overview of Connections for details. If your drain is a standpipe, fasten the drain hoses to the standpipe with the tie strap provided.

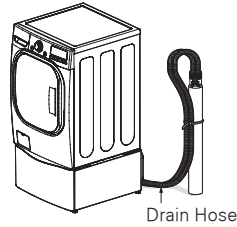

NOTE:

- Normal height of the end of the hoses should be approximately 35"~47" (90~120 cm) from the floor.
- Do not install the end of the drain hoses lower than 29". (73.7 cm) or higher than 96 in. (243.8 cm) above the bottom of the washer or more than 60 in. (152.4 cm) away from the washer.
- Never create an airtight seal between the hoses and the drain with tape or other means. If no air gap is present, water can be siphoned out of the tub resulting in poor wash/rinse performance or clothing damage.
- For best performance, if there is an additional drain hose from a hybrid dryer, place the drain hose in the standpipe next to the drain connector.
- If the standpipe is too narrow to fit both the drain connector and the dryer drain hose, the dryer drain hose may be inserted up to 3/4 in. into the center channel of the drain connector. See Overview of Connections, page 10.

⚠ CAUTION

- Inserting the dryer drain hose farther than 3/4 in. will cause leaking and improper draining.

OPTION 2: LAUNDRY TUB

Bend the end of the drain hoses to the desired shape and support them on the edge of the laundry tub. Use the tie strap to secure the drain hoses in place.

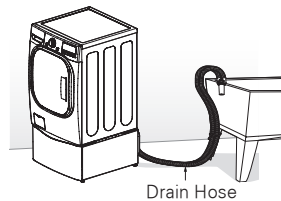

NOTE:

- Do not use this drain hose with a floor drain. The end of the drain hose must be at least 29 inches above the floor for proper draining to occur.

LEVELING THE WASHING MACHINE

The washer tub of your new washing machine spins at very high speeds. To minimize vibration, noise, and unwanted movement, the floor must be perfectly level and solid.

- Check that the washing machine is level.
 - Check for levelness by rocking the top edges of the washing machine or placing a level on the washing machine. The slope beneath the washing machine must not exceed 1/2°, and all four leveling feet must rest firmly on the floor.

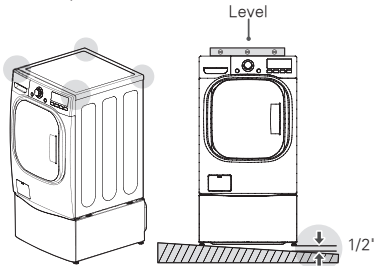

- Turn the lower leveling feet clockwise to level the washing machine.
 - Turning the lower leveling feet clockwise raises the washing machine.

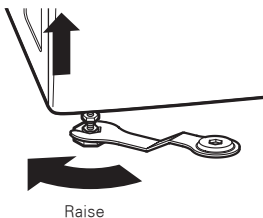

- Turn the locknuts counterclockwise and tighten them when the washing machine is level.

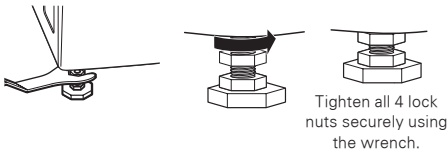

- Check again that the washing machine is level.
 - Push or rock the top edges of the washing machine gently to make sure that the washing machine does not rock.
 - If the washing machine rocks, repeat steps 1 to 3.

⚠ WARNING

- Using the washing machine without leveling may cause it to malfunction, producing excess vibration and noise.
- When stacking the full-size washing machine on the pedestal washer, use the leveling feet on the pedestal washer to level both. The full-size washing machine's leveling feet should be minimized and the locknuts turned counterclockwise to secure them.
- **Use the leveling feet only when you level the washing machine.** If you raise the leveling feet unnecessarily, it may cause abnormal vibration of the washing machine.

USING NON-SKID PADS (OPTIONAL)

If you install the washing machine on a slippery surface, it may move because of excessive vibration. Incorrect leveling may cause malfunction through noise and vibration. If this occurs, lay the non-skid pads under the leveling feet and adjust the level.

- Clean the floor to attach the non-skid pads.
 - Use a dry rag to remove foreign objects or moisture. If moisture remains, the non-skid pads may slip.
- Adjust the level after placing the washing machine in the installation area.
- Place the adhesive side of the non-skid pad on the floor.
 - It is most effective to install the non-skid pads under the front legs. If it is hard to place the pads under the front legs, place them under the back legs.

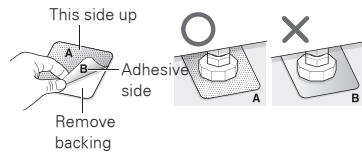

- Check again that the washing machine is level.
 - Push or rock the top edges of the washing machine gently to make sure that the washing machine does not rock. If the washing machine rocks, level the washing machine again.

CONNECTING TO THE POWER SUPPLY

The washer should be plugged into a 120 VAC, 60 Hz, 3-prong (grounded) outlet. Plug in the washer.

⚠ WARNING

- Improper connection of the equipment grounding conductor can result in risk of electric shock. Check with a qualified electrician or service technician if there is doubt that the outlet is properly grounded. Do not modify the plug provided with the appliance. Never damage or cut off the ground prong of the power cord. If the cord does not fit the outlet, have a proper outlet installed by a qualified electrician. Failure to follow these warnings can result in serious injury, fire, electric shock, or death.

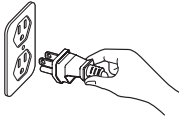

⚠ WARNING

- The power outlet must be within 60 inches (1.5 m) of either side of the washer.
- The appliance and outlet must be positioned so that the plug is easily accessible.
- Plug the washer into an electrical outlet which has a voltage rating that matches the rating plate. For best performance, plug the washer into its own individual outlet. This helps prevent overloading house wiring circuits which could cause a fire hazard from overheated wires. If necessary, use a new, UL-listed 3-prong adapter or 3-wire extension cord with a 3-prong (grounding) plug rated at no less than the branch circuit. Do not use an extension cord longer than three feet. Failure to follow these warnings can cause serious injury, fire, electric shock, or death.
- The outlet must be grounded in accordance with current wiring codes and regulations.
- Time-delay fuse or circuit breaker is recommended.
- It is the personal responsibility and obligation of the product owner to have a proper outlet installed by a qualified electrician.
- Do not use a worn or damaged power cord or power plug. Replace or repair it immediately. Failure to do so may result in death, fire, electric shock, or malfunction.
- Do not modify the power cord and take care not to damage it when installing or moving the washing machine. Failure to do so may result in death, fire, electric shock, or malfunction.
- Make sure that the washing machine is grounded.
- Connect this washing machine to a grounded outlet conforming to the rating prior to use. Failure to do so may result in fire, electric shock, or malfunction.
- Do not damage or cut off the ground prong of the power cord. Doing so may cause death, fire, electric shock, or product malfunction.

SORTING WASH LOADS

⚠ CAUTION

- Do not load items higher than the top edge of the tub. Failure to follow this caution can result in leakage or damage to fabrics.
- Use the Bedding cycle in the full-size washer for buoyant or nonabsorbent items such as pillows or comforters. Refer to owner's manual included with washing machine. Failure to follow this caution can result in leakage.

GROUPING SIMILAR ITEMS

For the best washing results, and to reduce the possibility of damage to clothing, sort the clothing into loads that are made up of similar items.

Mixing different fabric types and/or soil levels can result in poor wash performance, color transfer, discoloration, fabric damage or linting. Sort fabrics into groups as described below.

COLORS

Sort articles by color. Wash dark clothes together in a separate load from light colors or whites. Mixing dark clothes with light clothes can result in dye transfer or discoloration of the lighter clothes.

SOIL LEVEL

Wash heavily soiled clothing in the full-sized washer. Washing lightly soiled clothing in the same load with heavily soiled clothing could result in poor wash performance for the lightly soiled clothing. The pedestal washer is optimized for use with lightly soiled and delicate items.

FABRIC TYPE

Do not mix delicate items with heavier or sturdier fabrics. Washing heavier fabrics in a delicate load can result in poor wash performance for the heavier fabrics and possible damage to the delicate items.

LINT TYPE

Some fabrics attract and bind lint to them while others give off lint in the laundry process. Avoid mixing these lint collectors and lint producers in the same load. Mixing these fabrics results in pilling and linting on the lint collectors. (For example, lint collector – knit sweater; lint producer – terry cloth towels.)

SORT LAUNDRY...

By Colors	By Soil	By Fabric	By Lint
White	Heavy	Delicates	Lint Producer
Lights	Normal	Easy Care	Line Collector
Darks	Light	Sturdy	

FABRIC CARE LABELS

Many articles of clothing include a fabric care label. Using the chart below, adjust the cycle and option selections to care for your clothing according to the manufacturer's recommendations.

Fabric Care Labels

Machine wash cycle



Normal



Permanent press/
wrinkle resistant



Gentle/
delicate



Hand wash



Do not wash



Do not wring

Water temperature



Hot



Warm



Cold/cool

Bleach symbols



Any bleach
(when needed)



Only non-chlorine bleach
(when needed)



Do not bleach

LOADING THE WASHER

- Check all pockets to make sure that they are empty. Items such as clips, matches, pens, coins, and keys can damage both the washer and the clothes.
- Close zippers, hooks, and drawstrings to prevent these items from snagging or tangling on other clothes.
- Pretreat heavily stained areas for best results.
- To prevent an out-of-balance load, do not wash single items. Add one or two similar items to the load. Large, bulky items, such as a blanket, comforter, or bedspread, should be washed individually in the full-size washer.
- The washer will not fill or operate with the lid open.
- Don't overload the tub. Clothes should fit loosely in the tub under the maximum fill line. Loading clothes over the fill line may result in damage to clothing and the washer.

⚠ CAUTION

- Close the lid until it clicks before sliding the drawer in to begin the cycle.
- Press to open the lid. Do not force the lid of the washing machine open. Doing so may damage the machine.

DETERGENT AND DISPENSER USE

A WORD ABOUT DETERGENTS

High-Efficiency (HE) detergents produce fewer suds, dissolve more efficiently to improve washing and rinsing performance, and help to keep the interior of your washer clean. Using detergent that is not HE may cause oversudsing and unsatisfactory performance which could result in error codes, cycle failure, and machine damage.

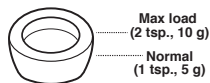

This machine requires very little detergent. For proper wash performance, always use the dispenser and measuring device provided with the machine.

The dispenser holds a maximum of 2 teaspoons (10g/10cc) of HE detergent. Most normal loads require only 1 teaspoon (5g/5cc) of detergent, or filling the dispenser to the halfway line.

Do not use a full detergent pod in the pedestal washer. Using too much detergent may cause oversudsing and unsatisfactory performance. Reduce detergent amount or add an extra rinse if detergent residue is left on fabrics. To add an extra rinse, press the Extra Rinse button.



DESIGNED TO USE ONLY HIGH-EFFICIENCY (HE) DETERGENT

IMPORTANT: Your washing machine is designed for use with only High-Efficiency (HE) detergents. HE detergents are formulated specifically for High-Efficiency washers and contain suds-reducing agents. Always look for the HE symbol when purchasing detergent.

IMPORTANT: Not all detergents are the same. Pay careful attention to the amount of detergent used to avoid oversudsing, poor rinsing and detergent buildup in clothing, and residue buildup that can contribute to odors in the machine. The maximum measure on the dispenser provided should only be used for very large loads. Using too much detergent can result in detergent buildup in the washer and in your clothes.

Always measure the detergent amount. While HE detergents are designed for this type of washing machine, be careful when measuring the detergent. For most normal loads, no more than 1 teaspoon or half the provided dispenser/measuring device of HE detergent should be used.

NOTE:

- Extra care must be exercised when using 2X and 3X concentrated detergents because even a little bit extra can contribute to the problems mentioned above.
- Detergents designated as HE compatible may not provide optimal results.

USING THE DETERGENT

1. Slide the drawer open, open the lid, and add the garments into the tub.
2. Measure the detergent with the detergent dispenser and pour it into the tub.
3. Close the lid, slide the drawer closed, and press the START/PAUSE button to start the cycle.

NOTE: Liquid chlorine bleach or powdered bleach cannot be used in the pedestal washer. To use bleach, use the full-size washer and follow instructions in the owner's manual for that machine.

IMPORTANT: Do not place or store laundry products, such as detergent, bleach, or liquid fabric softener, on top of your washer or dryer. Wipe up any spills immediately. These products can damage the finish and controls.

USING BLEACH

Do not use liquid chlorine bleach or powdered bleach in the pedestal washer. To bleach items, use the full-size washer and follow the instructions in the owner's manual included with that machine.

USING FABRIC SOFTENER

The pedestal washer chimes repeatedly before the final rinse so liquid fabric softener can be added to the load, if desired. Use 1/4 the amount of softener recommended by the manufacturer for a normal load.

When the machine chimes, press Start/Pause to pause the cycle.

1. Slide the drawer open, open the lid, and add the liquid fabric softener to the detergent dispenser. The softener can also be diluted with water and added directly into the tub. Do not pour undiluted softener directly onto clothing because it may stain fabrics.
2. Close the lid, slide the drawer closed, and press Start/Pause to restart the cycle.
3. To disable or enable the fabric softener alert, press and hold the Warm Water and Extra Rinse buttons at the same time for three seconds.

If you miss the softener add point:

1. Press the Power button to interrupt the cycle.
2. Select the Rinse+Spin cycle and press the Start button to start the cycle.
3. Add the fabric softener at the chimes following instructions above.