

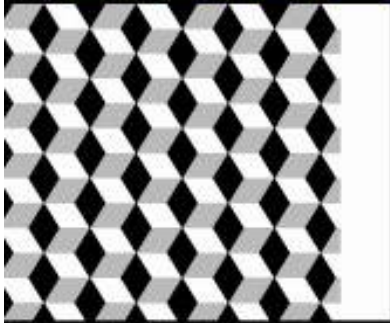

OWNER'S MANUAL



Accurate through Innovation
Simple by Design

A Saw Trax Exclusive:
Precision Sealed
Roller Bearings

"Precise & Smooth!"



From Portable

To Heavy Industrial

C52VP

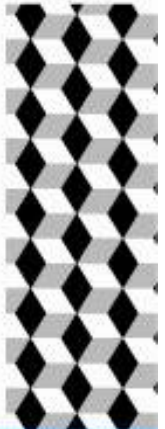

2064



*We make panel saws
to fit your needs.*

***Leading the industry in
panel saw innovations!***

Saw Trax Manufacturing
(770) 974-0021
1-888-729-8729
info@sawtrax.com
www.sawtrax.com

Table of Contents

Parts Diagram	2
Installation & Set Up	3
1.. Moving the unit	3
2.. Open & secure the folding stand	3
3.. Lowering side stand legs	3
4.. Installing Retraction Mechanism	3
5.. Adjusting the tension of the retraction spool	4
6.. Attaching the cord holder	5
7.. Ensuring Square	5
8.. Putting on the horizontal measuring tapes	5
9.. Putting on the vertical measuring tape	5
10.. Attaching the dust brush	6
11.. Placement of the dust collection hose & power cord	6
Cautions & Warnings	7
General Use Instructions	8
Inserting/removing tool plates in the carriage	8
Rotate saw from cross cut to rip cuts	8
Cross cutting material	8
Rip cutting material	9
How to adjust the score cut and bevel cut (Only with the Makita saw)	9
Using the stop bar & tape	9
Changing the saw blade	9
Maintenance and Care	10
Trouble Shooting & FAQs	11
Warranty	12
Accessories - Installation & Use	13
Mid-Fence	13
Builders Extensions	13
Spring hold down	13
Sheet Clamp	14
Laser Pointer	14
Flip Stops	14
Frame Dust collection	15
ACM cutter	15
Knife Plate	16
Pivoting Knife Plate	16
Floating router Plate	17
Wall Mounting System	18

Parts Diagram

1. Retraction Mechanism with spool
2. Cord Holder
3. Guide tube bracket (top & bottom)
4. Guide tubes -2
5. Dust pan
6. Folding Stand
7. Hinge for folding stand - 2
8. Cross brace for folding stand
9. Measuring tapes on measuring track- 2
10. Material Fence-2
11. Fence lip-2
12. Material rollers (10-18)
13. Center step
14. Accu-Square alignment
15. Frame Vent
16. Transport wheels - 2
17. Horizontal bars of Frame (3-4)
18. Vertical bars of Frame (4-6)

CARRIAGE & INSERT

19. carriage locks (2)
20. Sealed roller bearings (4)
21. Carriage Frame
22. Insert Plate
23. Trigger lock (not on 2000 series)
24. Saw Motor
25. Dust hood / with dust port
26. Dust hose
27. Carriage pins

NOT PICTURED

28. Dual rip gauge - Black banding that runs along the side of the guide tubes.
29. Rip gauge pointers -2 Bronze metal pointers that are located on the carriage near the carriage locks.

FULLSIZE UNITS ONLY

30. Accu-Fence alignment system
31. Side stand legs - one on each side of the unit.

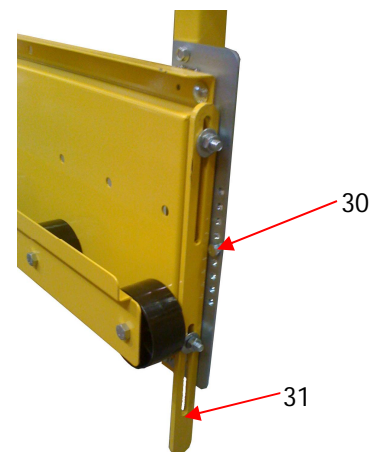
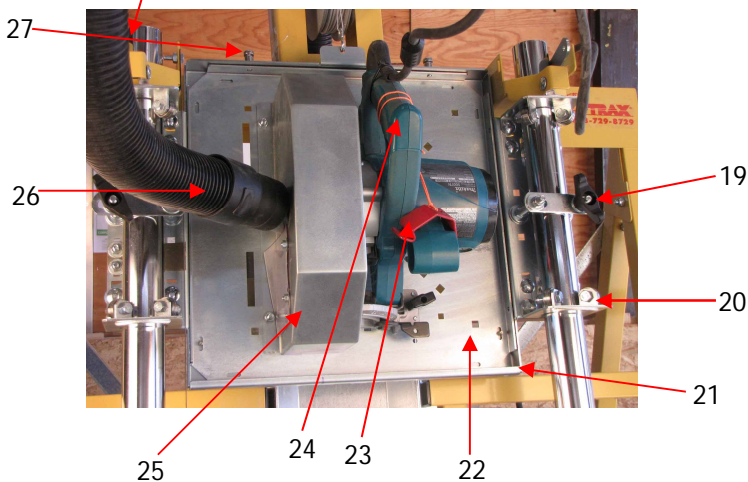
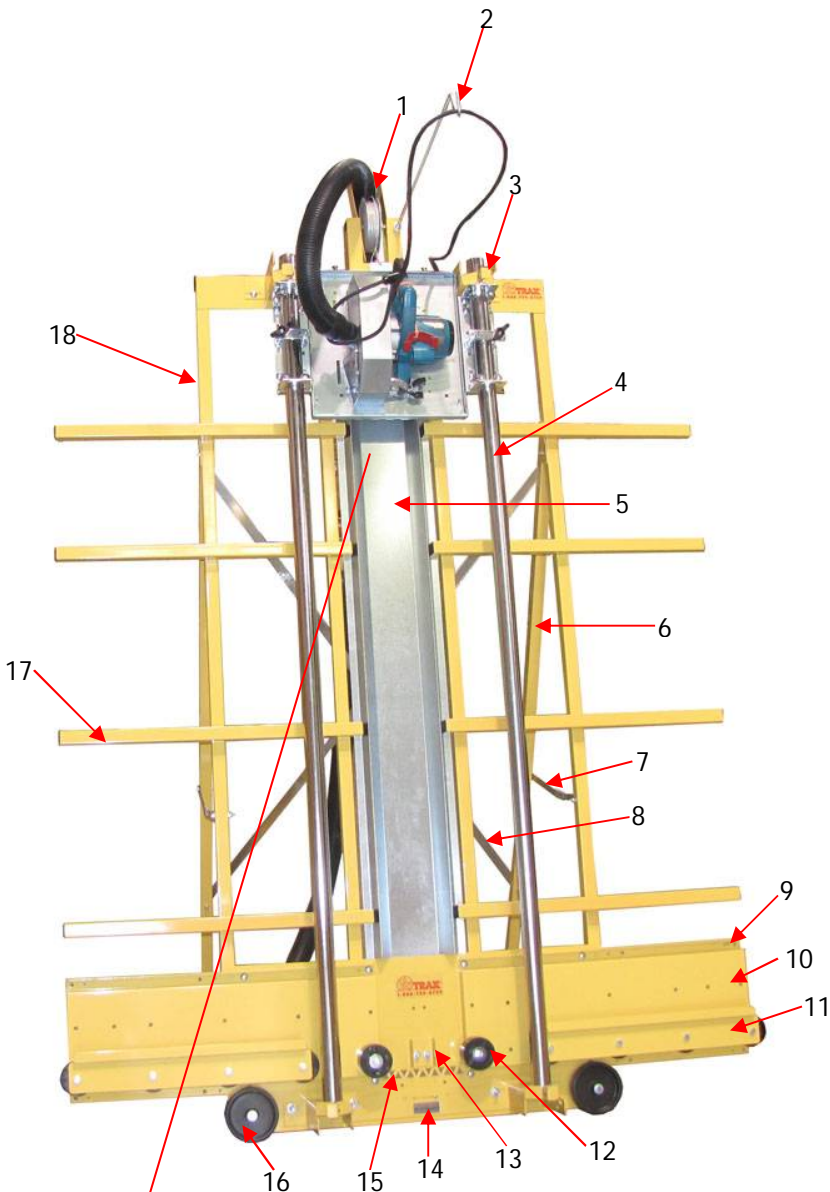

Installation & Set Up

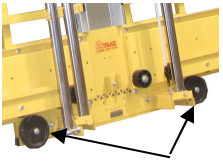

1. Moving the unit

- a. Once you uncrate the unit you will need to transport it to a location where you will set it up. To roll the unit, tilt it vertically so the wheels make contact with the ground & roll.
- b. Stand & wheels are not standard on the Basic or Classic models- See wall mounting instructions in the Accessories Instructions.

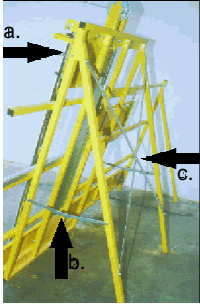

2. Open & secure the folding stand

- a. Open legs that are attached to the triangle bracket.
- b. Push down on the hinges to securely lock the stand completely open.
- c. Cord holder is taped to the back brace for later installation & use.

NOTE: If you have an 88 or 100 cross cut machine please see:
<http://www.sawtrax.com/video/2.2MtrAssemblyhi.wmv>

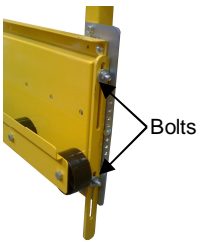

3. Lowering side stand legs

- a. **FULL SIZE UNITS ONLY:** Using a socket wrench, loosen the side stand legs on each side of the unit so they may make contact with the ground. Then tighten each bolt to properly stabilize the unit.
- b. Compact units do **NOT** need or have side stand legs.

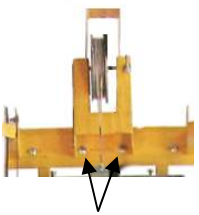

4. Installing Retraction Mechanism

- a. Remove the retraction mechanism from the packed box to install on frame. Remove the two center bolts, nuts and washers in the top guide tube support bracket of the frame. Use these bolts to attach the retraction mechanism to the top of the machine and tighten the nuts on the back.

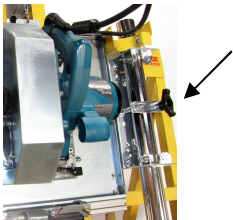

- b. Lock the carriage in place by tightening the black knobs on each side of the carriage before inserting the saw.

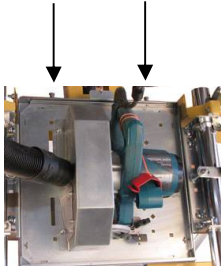

- c. On the carriage, lift the pins by pulling up and twisting a 1/4th turn. The pins will stay in the up position so you may insert the saw into the carriage. Remove the saw insert from the box and place it into the carriage by placing the base of the plate on the bottom lip of the carriage (make sure the cord is facing the top of the plate as pictured) Next, tilt the plate inward until the plate is completely inserted. Ensure that the holes are lined up with the pins by applying inward pressure to the plate. Twist to drop pins and make sure pins are completely seated.

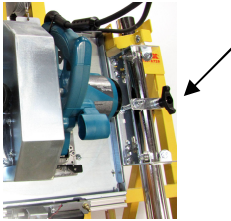

- d. Push the carriage with the saw in it all the way up and lock in place by tightening the black knobs on each side of the carriage.

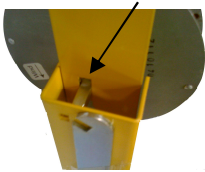

- e. To attach the retraction cable to the carriage, ensure the hose channel bracket on top of the retraction mechanism is all the way down. Slide the top bracket so the slot is down preventing the square rod from spinning.



- f. Attach the S hook on the cable to the carriage and crimp closed with pliers. While holding the carriage, loosen the black knobs and allow it to slowly descend to the ground.

NOTE: If you have a double spool system attach the smaller spool's "S" hook to the larger spool's "S" hook and proceed to the next step.

5. Adjust the tension of the retraction spool

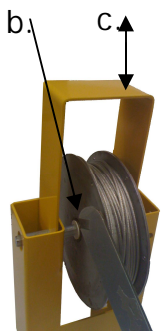

- a. A spool wrench has been taped to the side of the retraction mechanism.
- b. Place the slot of the wrench onto the square rod that holds the spool in the retraction housing and apply upward pressure with the wrench to loosen the hose channel
- c. Raise the hose channel and rotate the wrench up until you cannot go further. Lower the hose channel to lock the square rod in place.
- d. Remove the wrench to readjust the position & repeat the steps above until the desired tension is obtained. Usually, raising the carriage about a foot from the top will work well. Save the wrench for future use.

6. Attaching the cord holder

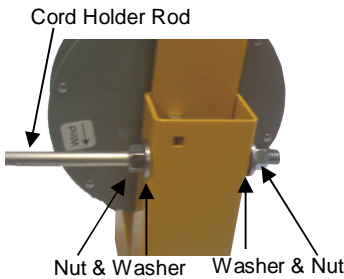

- Remove the cord holder that is attached to the folding stand. (see step 2)
- Remove one washer and one nut. The rod should still have 1 nut & washer tightened to the end of the threads.
- Insert the rod through the hole in the retraction mechanism until it is all the way through. Place the other washer and nut on the holder and tighten.
- Make sure the V shape on the end of the cord holder is pointed down.

7. Ensuring Square

Square if measurement of Line A = Line B & they intersect in the center.

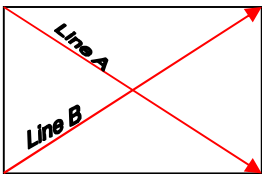

- All units are aligned prior to shipping so there should be no need to adjust the square of your unit.
- Before installing measuring tapes please check accuracy by placing a full sheet on the bottom rollers and making a test cut. Start with a squared sheet, make test cut and re-measure for square. (See GENERAL USE INSTRUCTIONS for cutting instructions.)
- NOTE: Most factory cut sheets are not truly square!!!!
- Should your machine not be square, call us at 1-888-SAWTRAX.

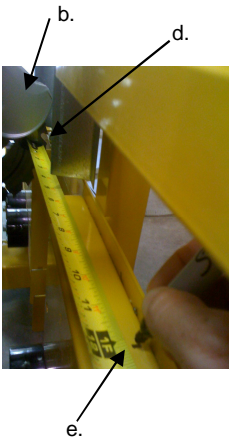

8. Putting on the horizontal measuring tapes

- NOTE: If you ordered builder's extensions, install them before putting on your tapes.
- Clean measuring Track on the top edge of the fence.
- Position saw to the fence level.
- Move saw blade guard to expose blade
- Measure from blade to 12 inches & mark the measuring track of the fence. Then move saw out of your way.
- Peel the backing of the measuring tape and match tape with mark on the measuring track of the fence.
- Snap off excess tape from both ends.
- Repeat process for both fences.
- Note: Each insert cuts at different marks. We suggest aligning your tapes with the insert you plan to cut with most.

9. Putting on the vertical measuring tape

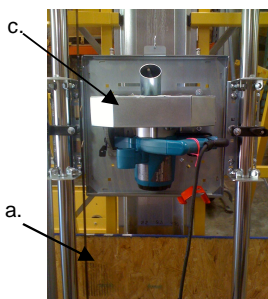

- Using a piece of material of known size. (21 inches in the example picture)
- Place the material in the center of the panel saw. Turn the saw sideways for ripping. (see rotating saw in general use instructions)

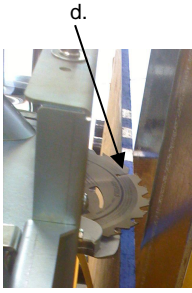

c. Make sure the dust cover of the saw is positioned above the motor.
(As in the Picture)

d. Place the saw so the saw blade is touching your piece of material.
(Make sure the blade guard is out of the way)

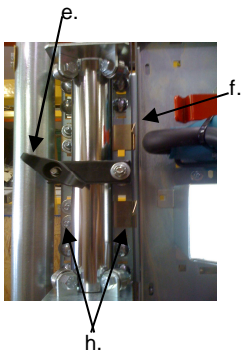

e. Secure the place of the saw by locking down the carriage locks.

f. Peel the backing of the measuring tape and match tape (example: 21 inches) with top rip pointer on the carriage. (Classic model only has 1 pointer) Then adhere the tape to the entire banding.

g. Remove & re-insert the plate with the motor above the dust hood.
(Repeat step d & e).

h. Adjust the bottom pointer by loosening the bolts and moving the pointer to read the same measurement. (example: 21 inches) Then re-tighten the bolts.

10. Attaching the dust brush



a. Place the brush around the saw blade on the bottom of the saw plate.
Brush is magnetic so it can be removed for cutting thick material.

b. You may permanently attach it by using a self tapping screw to secure it to the plate. Be careful not to drill into the saw.

11. Placement of the dust collection hose & power cord

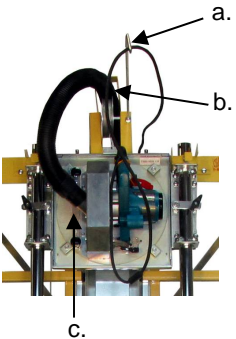

a. Place power cord in the V shape of the cord holder and place plug end behind the units frame.

b. Feed the vacuum hose through the hose channel and make sure smaller end is in the front of the unit.

c. Connect smaller end to dust port on the saw hood.

d. Connect the larger end to a vacuum (not provided). A coupler is provided so you **may** connect 2 vacuum hoses together.

Cautions & Warnings

- ✓ A saw manual is included with your purchase. Follow all instructions that are included in your power tool manual.
- ✓ Stay alert, watch what you are doing & use common sense.
- ✓ Always use Safety protection such as glasses, earplugs, dust mask & closed toe shoes.
- ✓ Keep area of operation clear, clean & well lit.
- ✓ Do not operate near water or flammable liquids.
- ✓ Make sure the unit is on solid ground with all legs making contact with the floor.
 - a. Ensure Side stand legs are down – only for full size units.
- ✓ Never climb on machine.
- ✓ Disconnect all power cords prior to changing blades, changing insert plates or when transporting the unit.
- ✓ Ensure pins are properly seated before pulling on the carriage.
- ✓ Tighten carriage locks to secure carriage when changing plates.
- ✓ Keep hands off carriage guidance rails.
- ✓ Keep hands from underneath carriage area.
- ✓ Power Cord should be on the cord holder to prevent cutting cord & electrocuting yourself.
- ✓ Connect dust hose & turn on vacuum (not provided) before using saw to prevent dust in eyes. (ALWAYS USE SAFETY GLASSES!)
 - b. Classic model does not include dust collection, but has enclosed hood to redirect dust flow.
- ✓ Never remove the S-hook from carriage once retraction mechanism is attached.
- ✓ Make sure the blade is not spinning before removing material or retracting saw carriage.
- ✓ Properly maintain your equipment according to the Maintenance and care instructions.
- ✓ Worm Drive saws (2000 series) use oil that must be changed. Please refer to the saw motor's instruction manual.

General Use Instructions

Inserting/removing tool plates in the carriage

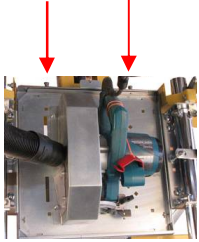

- On the carriage, lift the pins by pulling up and twisting a 1/4th turn so that pins stay in the up position so you may insert the tool into the carriage.
- Place the insert into the carriage by setting the base of the plate on the bottom lip of the carriage (make sure the cord is facing the top of the plate when inserting the saw as pictured)
- Tilt the plate inward until the plate is completely inserted. Ensure that the holes are lined up with the pins by applying inward pressure to the plate.
- Twist to drop pins and make sure pins are completely seated.
- NOTE:** Some inserts only fit the carriage in one position. If the insert will not fit into the carriage, you may have the tool set in the wrong direction. Rotate the plate & re-inserting it in the carriage.

Rotate saw from cross cut to rip cuts

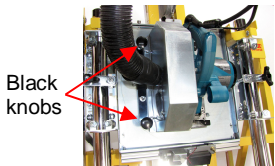

- Spinning insert- Pull the 2 black knobs up & slightly rotate. Complete the rotation by spinning the saw motor until the pins reseat. **DO NOT** use the black knobs to completely rotate the plate as this may cause damage to the plate or pins.
- Standard plate – Remove plate from carriage, rotate plate and re-insert plate with the tool set in the horizontal position. (see inserting/removing tools)

Cross cutting material

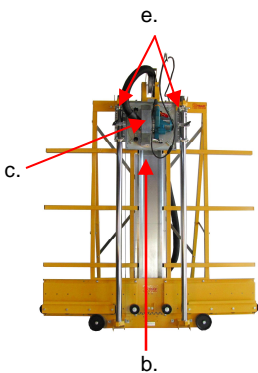

- Make sure the unit is secure and operational.
- The carriage should be at the top so material can clear.
- Make sure the saw (or other cutting tool) is in the vertical position.
- Insert and align material so the blade will cut where desired.
- Carriage locks need to be loose so carriage is free to move without any friction.
- Secure your material as you are cutting.
- Allow blade to stop spinning before removing cut material or raising the saw.
- Do **NOT** allow carriage to retract to the top on its own. Always assist retraction of carriage.

Rip cutting material

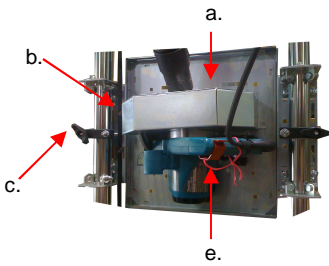

- a. Set your tool in the horizontal position.
 - b. Use the rip gauge pointers to set cutting height.
 - c. Set and secure the tools cutting height by tightening the Carriage locks.
 - d. Insert the material to cut.
 - e. Place the trigger lock for hands free saw operation.
(Worm drive saw has on/off switch & a trigger lock is not needed)
- a. Support your material as you are cutting. (Compact unit)
 - b. Remove the trigger lock & allow the blade to stop spinning before removing the material. (power off switch for worm drive saw)

How to adjust the score cut and bevel cut (Only with the Makita saw)



- a. Remove the dust hood. There will be NO dust collection feature when score cutting or bevel cutting.
- b. Adjust the scoring depth by loosening the black lever (near the power cord), then set desired depth and re-tighten the lever.
- c. Adjust the bevel by loosening the black lever (near the blade), set desired bevel & re-tighten the lever.
 - i. NOTE: When bevel cutting it may be necessary to use a 2nd piece of material as a backing so the blade may clear your cutting material.
- d. Once finished score cutting or bevel cutting make sure the saw is set back to the original position then re-install the dust hood.
 - i. NOTE: If dust hood doesn't seem to fit securely, double check to make sure the saw is fully reseated. Levers should be set at 0°.

Using the stop bar & tape

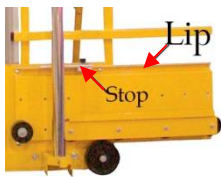

- a. The stop can be used on the left or right.
- b. The strip bar attached to the stop is set up for the right side by default. (The bar allows you to cut strips less than 6 inches)
- c. Loosen the black knob on the stop so it can fit over the lip.
- d. Set the stop at the desired measurement and tighten knob so the stop does not move.
- e. When finished using the stop always remove it from the fence lip.

Changing the saw blade

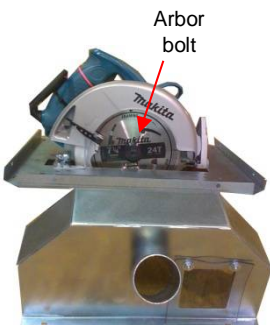

- a. Make sure your saw is unplugged!
- b. Remove the insert from the carriage so you may easily access the blade.
- c. Remove the dust hood to expose the arbor bolt.
- d. See saw manufacturer's instruction manual for exact instructions for changing the blade. (Varies per model)
- e. Replace the dust hood.

Maintenance and Care

Keep unit free of dust build- up. Periodically blow dust from all moving parts, including the rollers that support the material.

Make sure you are using the appropriate blade for the material you are cutting.

Sharpen saw blade on a regular basis.

Should the frame's coating get scratched, use touch-up paint to prevent exposed metal from rusting.

Periodically apply silicone spray to the spinning insert, guide tube and roller bearings.

Follow all maintenance & care instructions for your saw motor according to the saw's instruction manual.

Trouble Shooting & FAQs

YES THESE ARE REAL QUESTIONS WE HAVE RECEIVED OVER THE YEARS

What is this red or black thingy?

It is your trigger lock for rip cutting. It keeps the saw motor running. (See General use - rip cutting instructions)

How do I keep my saw ON so the blade will spin continuously on so I can rip cut?

Use the red or black thingy, known as the trigger lock. (See General use - rip cutting instructions)

Why is my saw so loud?

The silencer wasn't installed! (It's a saw; it's supposed to be loud.)

Why isn't my dust collection working?

Make sure the hoses are connected to the vacuum and the vacuum is on.

What is this silver block with a bar for?

It is your Stop bar. (See General use - using the stop bar & tape)

Can this saw cut angles?

Yes, but only 90°. These units are designed to cut SQUARE!

My saw isn't cutting square, what's wrong?

Make sure the material you start with is truly square. (Believe it or not most factory cut sheets aren't square) If the sheet is square before cutting, please call us.

When cutting acrylics my material is cracking, what am I doing wrong?

Make sure you are using a blade that is designed to cut acrylics. If you are still having an issue you may want to move your material rollers to the higher position and cut from the bottom up.

Why am I experiencing chip-out when cutting Melamine material?

Unfortunately this is a flaw with the material. Chip out can be minimized by cutting slowly and using a blade that is designed for this type of material.

Warranty

Every Saw Trax Vertical Panel Saw is thoroughly inspected before leaving the factory. It is warranted to be free from defects from workmanship and materials for one year on all components except the saw motor. Should any trouble develop during the warranty period, contact us for a RMA & return that component with proof of purchase date, freight prepaid to Saw Trax Mfg. Co. Inc. If inspection shows the trouble caused by defective workmanship or materials, Saw Trax Mfg. Co. Inc. will repair (or, at our option, replace) without charge.

This warranty does not apply where:

- Repairs have been made or attempted by others.
- Repairs are required because of normal wear and tear.
- The tool has been abused, misused or improperly maintained.
- Alterations have been made to the tool.
- Corrosion and / or rust have developed due to scratches in the finish.
- The saw motor is covered by the saw manufacturer's warranty and is not covered by SawTrax Mfg.Co. , Inc.

In no event shall Saw Trax Mfg. Co., Inc. be liable for any indirect, incidental or consequential damages from the sale or use of this product. This disclaimer applies both during and after the duration of this warranty.

Saw Trax Mfg. Co. Inc. disclaims liability for any implied warranties, including (but not limited to) implied warranties of "merchantability" and/or "fitness" for a specific purpose, after the term of this warranty.

Accessories – Installation & Use

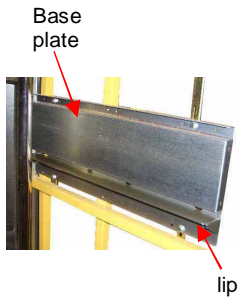

Mid-Fence - Instead of cutting small pieces on the bottom rollers of the machine, use the mid fence to hold small pieces. This allows for easy waist high cuts.

- This accessory is Pre-installed
- The base plate is a fixed plate and the lips are removable. Remove the lip when cutting larger sheets. To remove the lips, simply lift the lip up and pull outward.
- To attach the lip, line the tabs with the slots of the base plate. Insert the tabs and make sure they completely drop into the slot.



Builders Extensions - Changes a Compact into a full size base or a Full Size base to one that is almost 15' wide. It is ideal for making it easier to rip a full size sheet on a Compact on a regular basis.

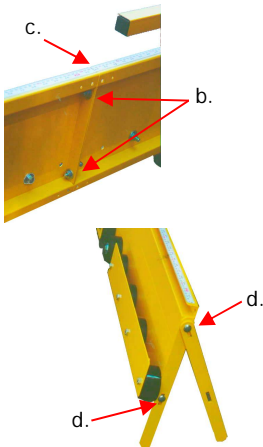

- FULL SIZE UNITS ONLY:** You will need to remove the existing side stand legs before installing the extensions.
- Align the square holes on the edge of each extension with the square holes on the unit. Insert the provided bolts through each of the two holes. Attach the washer and the nut to the back side of each bolt.
- Align the fence along the top edge and tighten the nuts.
- On the outside end of the extension, attach the side stand legs in an "A" shape. (as shown in the picture) They must come in contact with the floor to stabilize the unit.
- Attach measuring tapes. (see installation instructions)

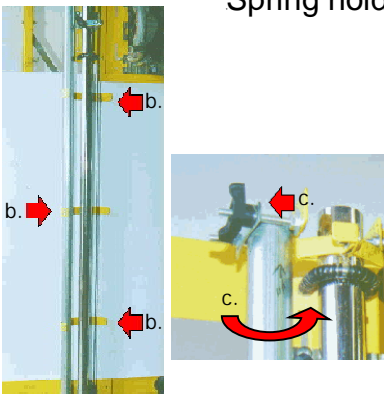

Spring hold down - Holds thin material against the fence while cutting. Recommended for material 1/4" or thinner.

- This accessory is Pre-installed
- The design of the spring fingers will allow material up to 1/4" thick to be inserted from either side.
- Adjust the tension by loosening the black knob located at the top of the spring hold down. (located at the bottom for taller units) Then rotate the spring hold down & retighten the black knob.
- The spring hold down can be removed as needed.

Sheet Clamp - Is used as an extra hand to hold material in place so you don't have to. It is especially handy with cutting long narrow pieces on the material rollers or long pieces on the mid fence.

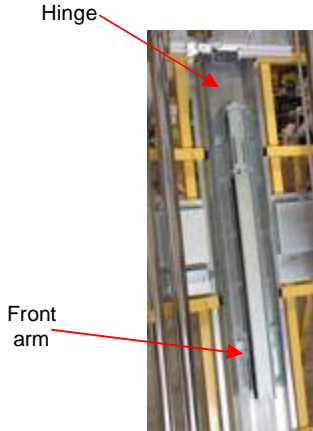

- a. Make sure the dust pan & magnet on sheet clamp is free of dust & debris.
- b. Place the magnetic side of the sheet clamp in the center of the dust pan with the hinge to the top. (It will self center so it will not interfere with the blade's cutting position)
- c. Adjust the height placement by sliding the entire clamp up or down on the dust pan.
- d. To clamp your material, lift the front arm of the clamp. A top magnet will keep it in the open position for you. Slide your material underneath the front arm, then lower the arm to secure your material.
- e. **WARNING!!!!** You must remove the sheet clamp before rip cutting or using the router insert. Do not attempt to rotate your saw to a horizontal position when the clamp is in the dust pan.

Laser Pointer - Allows you to easily see where you are cutting before you make the cut.

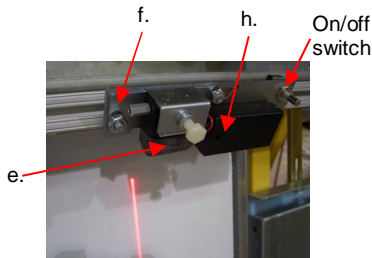
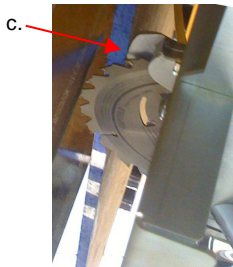

- a. This accessory is pre-installed. Adjust laser line position before using.
- b. Make sure your unit is square. (See installation instructions)
- c. Pull back your blade guard, and set a truly squared sheet against the saw blade. Turn on laser.
- d. Loosen the laser assembly on the aluminum extrusion until the laser's line is even with the material. Bolts are located underneath the laser's bracket.
- e. To adjust the angle of the laser's line roll back rubber guarding on the laser to expose the plastic wheel. Use this wheel to make minor adjustments.
- f. You may also adjust the angel of the entire laser bracket by loosening nut and swinging laser housing, then re-tightening nut.
- g. Remove the material and use a permanent marker to draw a line where the laser's light is on the silver dustpan for easy re-alignment.
- h. Change the batteries by removing the tiny screw and sliding back battery cover.
- i. **To Use:** Make sure the laser lines up with the mark you made on the dust pan. Then slide your material into place, align your measurement with the laser line and make your cut.
REMEMBER to turn off power after each use.

Flip Stops - Saves time when cutting standard lengths of material. Two adjustable stops are included.

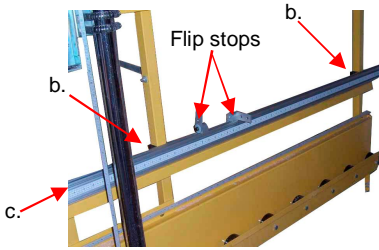

- a. Loosen the bolts that attach the “hat” bracket to the aluminum extrusion until you can slide them out of the groove & off the extrusion.
- b. Place the “hat” bracket over the vertical square tubing from the backside of the frame. (as pictured)
- c. Slide the aluminum extrusion back onto the bolts and line the extrusion up with the end of the horizontal tubing closest to the carriage.
- d. Tighten bolts on the “hat” bracket till the extrusion no longer moves.
- e. Attach measuring tape on facing of the extrusion. (see installation instructions-putting on horizontal tapes)
- f. To set flips, loosen bolts on the flip stops. Slide to desired placement & tighten. Push the arm bar down to use. When not in use, push the arm bar up so material may slide pass the stop.

Frame Dust collection – Secondary dust collection for the bottom frame of the panel saw. This collects most of the dust before it hits the floor.

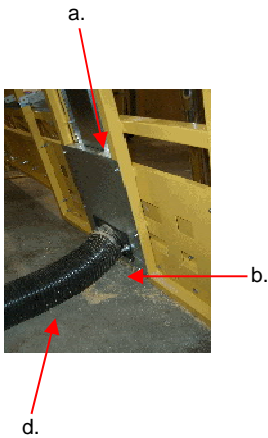

- a. Remove the pre-installed base plate located on the back of the unit.
- b. Attach the 4 inch coupler to the base plate using the bolts that have been pre-inserted on the coupler. The coupler should be attached on the flat side of the plate.
- c. Re-attach the base plate to the back of the unit.
- d. Attach a 4 inch hose to the coupler & to a dust collector. (hose not provided)
- e. **NOTE:** An industrial vacuum system is recommended for effective dust collection.

ACM cutter - Cuts Aluminum composite material, (such as Diabond & Alumacore), expanded PVC, (Such as Sintra & Forex) without dust.

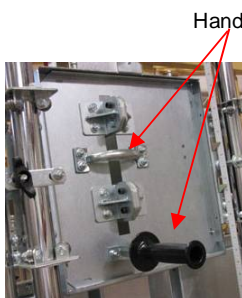

- a. This insert can only be inserted in a vertical position.
- b. Place & secure your material so it will not move. Firmly hold both handles and pull the insert down, completely through the material. Remove your material so the insert may retract without interference.
- c. This insert is not capable of Rip cutting.

Knife Plate - Used to cut softer material, such as, foam board, corrugated PVC, Cardboard, & 4mm Coroplast.

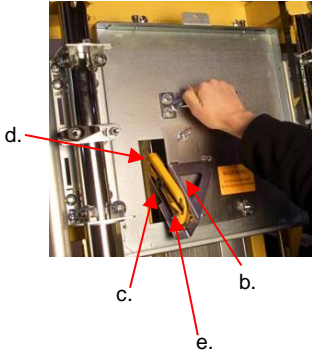

- a. This plate may be inserted in a horizontal or vertical cutting position. (see General use - changing inserts section)
- b. Move entire knife bracket close to the material by loosening the wing nut located under the triangle frame. Then retighten the wing nut.
- c. Extend the cutting blade by loosening the gray knob, sliding the knob just enough for the blade to go through your material and then retighten the knob.
- d. To help prevent your blade from creating a wavy cut, tighten the black stabilization screw located on the knife near the blade end.
- e. To change the blade, loosen the gray knob (pictured as C) until it can pass the yellow notch, then slip the entire knob and blade out the back side of the knife.

Pivoting Knife Plate - Used to cut softer material, such as, foam board, corrugated PVC, Cardboard, 10 mm Coroplast and capable of score cutting harder material such as expanded PVC or dry wall.

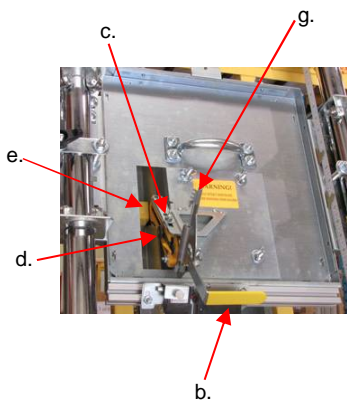

- a. This plate may be inserted in a horizontal or vertical cutting position. (see General use - changing inserts section)
- b. Push the Yellow-handled lever down so the knife is in the cutting position.
- c. Move entire knife bracket close to the material by loosening the black wing nut located above the knife's body. Move entire knife bracket then retighten wing nut.
- d. Extend the cutting blade by loosening the gray knob & sliding the knob just enough for the blade to go through your material. Retighten the knob to set the blade position.
- e. To help prevent your blade from creating a wavy cut tighten the black stabilization screw located on the knife near the blade end.
- f. Once you have completed your cut, push the yellow lever up so the knife will no longer be in the cutting position. This will allow the knife plate to retract to the top without hitting the material. You can make several passes along the same cut line to score more rigid material such as expanded PVC.
- g. To change the kick back tension on the pivoting mechanism adjust the spring end to a different mounting location.
- h. To change the blade, loosen the gray knob (pictured as d) until it can pass the notch located near the back side of the knife and slip the entire knob and blade out.

Floating router Plate - This insert will allow you to use a router to make consistent depth dados.

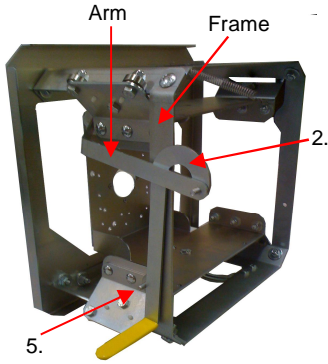

- a. Installing the handle-
 1. Remove both nuts from the J-shaped handle and set aside for later use.
 2. Fit the J-shaped handle (open end face up) between the arm and the router insert frame.
 3. Place the threaded studs of the handle into the small hole of the arm and the small hole along the side of the insert's frame.

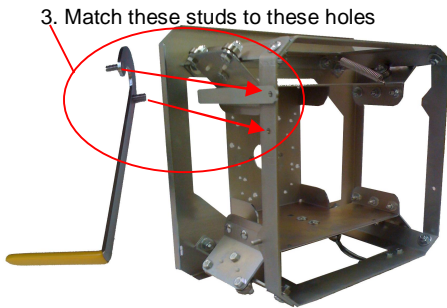

4. Attach nuts to both threaded studs on the handle. Tighten securely, then back off by $\frac{1}{4}$ - $\frac{1}{2}$ of a turn to make sure that the handle can still move. (Not too tight.)
5. Ensure the J handle is lying on top of the stud attached to the frame of the insert and the Yellow handle is pointing away from the frame

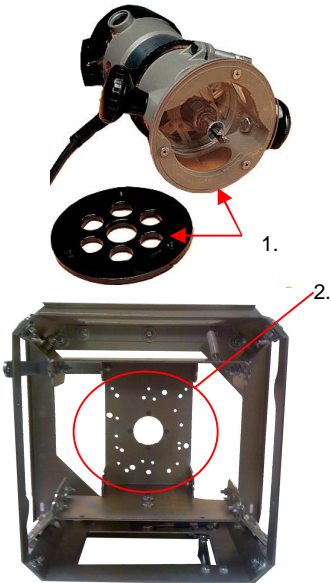

- b. Mounting the router
 1. Remove base plate from bottom of the router and save the screws for later use.
 2. Place the router into router insert frame. Align router base holes with the holes that are pre-stamped on the insert's plate.
 3. Insert router's screws from the outside of the plate into the router.

- c. If your router doesn't match the hole pattern-
 1. Use base plate from bottom of the router as a template. Mark the hole pattern and drill into the plate. Then follow directions above.

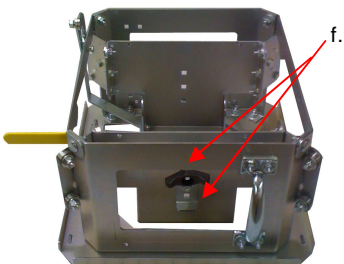

- d. Insert the plate onto the unit's carriage with the "THIS SIDE UP" sticker on the top.
- e. Use Yellow handle to lower and raise your router.
- f. To adjust the Depth Regulator, loosen the black wing nut, set the desired position of the top and retighten the wing nut to secure the regulator in place.

Wall Mounting System- Used to permanently attach your unit to a wall.

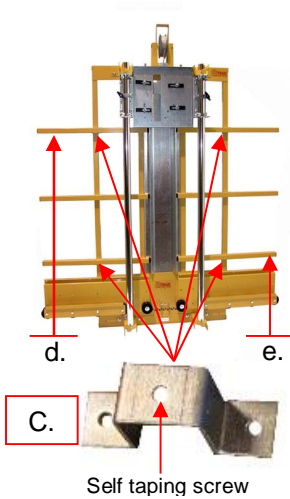

- a. You will need to provide two 2x4 boards, each 4 feet long. All mounting brackets, screws and a nut driver are included in this accessory package. If you have a folding stand on your unit you will need to remove it.
- b. When deciding where to wall mount your unit, consider your work space, not the unit's width. (Example: If you typically rip cut 4x8 sheets, you will need at least 8.5 feet of working space on each side of the cutting blade, for a total of 17 feet of working space.)
- c. Using the $\frac{1}{4}$ X $\frac{3}{4}$ self tapping screws, attach the wall mounting brackets to the vertical square tubes just below the top & bottom horizontal tubes as illustrated.
- d. Measure the height of the TOP horizontal bar and add 1 inch to this measurement.
- e. Measure the height of the BOTTOM horizontal bar and add 1 inch to this measurement.

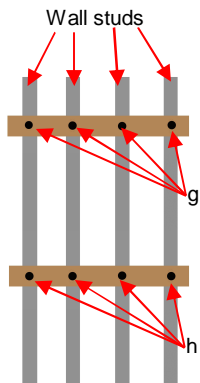

- f. Once you have decided where to mount your machine, find and mark the studs.
- g. Using the measurements of step **d**, mark the height placement on each of the wall studs. Attach one 2x4 across the studs, using four(4) of the $\frac{1}{2}$ x 4" self tapping screws, as illustrated.
- h. Using the measurements of step **e**, mark the height placement on each of the wall studs. Attach one 2x4 across the studs, using four(4) of the $\frac{1}{2}$ x 4" self tapping screws, as illustrated.
- i. Position your unit with the wall mounting brackets against the 2x4's on the wall. Use the $\frac{1}{4}$ x $1\frac{1}{2}$ self tapping screws to permanently attach each bracket to the 2x4's.
- j. Once completed, pull on the unit to ensure it is secure and will not come off the wall.
- k. **WARNING!** This unit is heavy and could cause injury if improperly mounted. Always check the security of the machine prior to use.