

UHS

Spa Owner's Manual

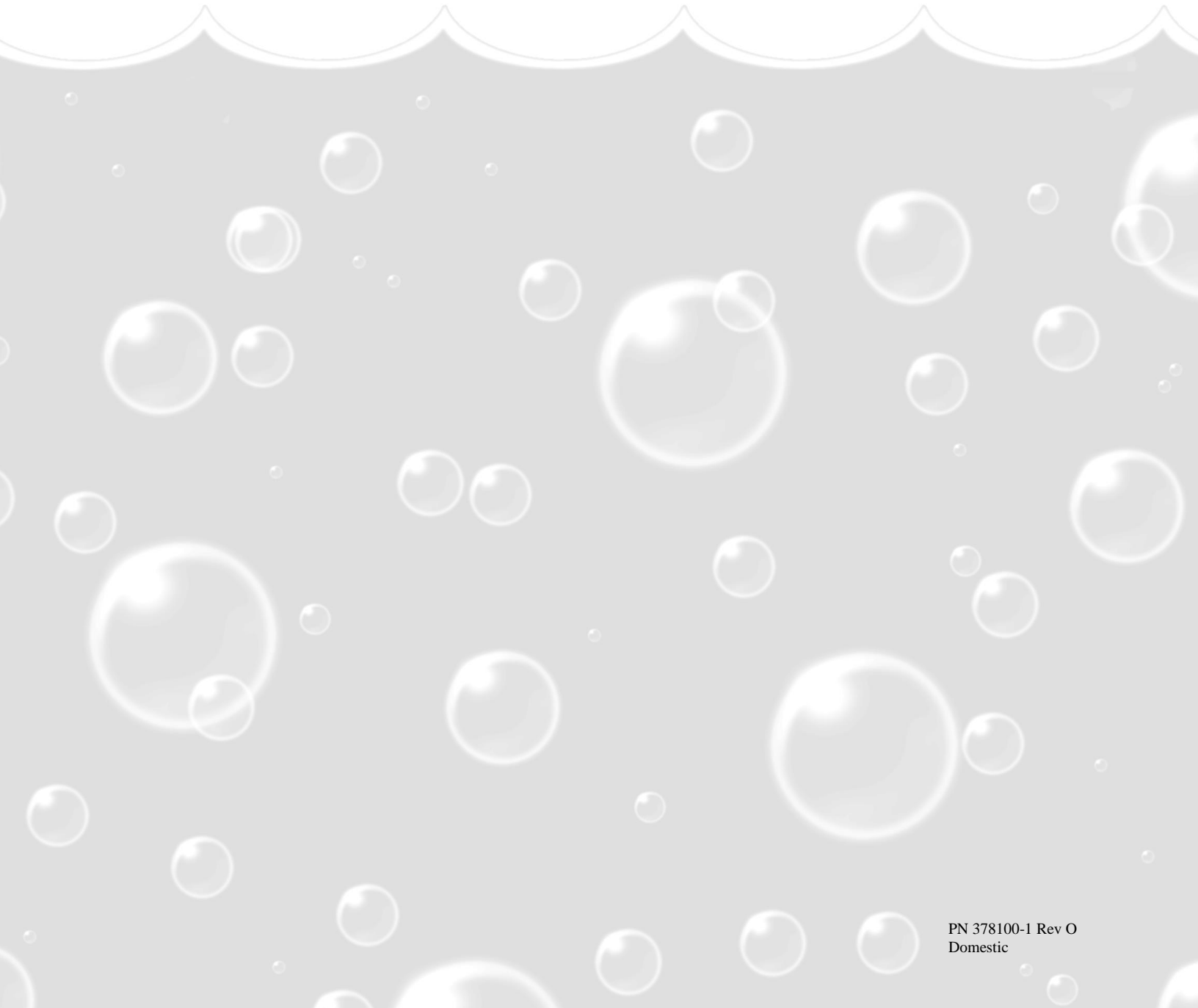

OWNER'S INFORMATION

DEALER

Company _____
Address _____
Phone _____
E-mail _____

INSTALLER

Company _____
Address _____
Phone _____

SPA

Model (see below) _____
Serial Number (see below) _____
Color _____
Date of Delivery _____

For the model and serial numbers, locate the white plate to the right or left of the access door, near the floor.

 Intertek 3126636	Roto Ops LLC Lake Mary, FL CONFORMS TO UL STD 1563 CERTIFIED TO CAN/CSA STD C22.2 NO 218.1-M89 ESA # 9000081	RATINGS:	
		Volts: _____	_____
Model No.: _____		Amps: _____	_____
Mfg Date: _____		CirBkr: _____	_____
		Hz: _____	_____
		SN: _____	_____
FOR INDOOR/OUTDOOR USE		Made in the U.S.A.	

TABLE OF CONTENTS

IMPORTANT SAFETY INSTRUCTIONS.....	4-5
SELECT A LOCATION.....	6
SPA COVER INSTALLATION.....	7
FILLING YOUR SPA.....	8
DRAINING YOUR SPA.....	8
SYSTEM OPERATION.....	9
AIR INJECTION VENTURI ADJUSTMENT.....	10
SURFACE SKIM FILTER	10
REMOVING AND CLEANING THE FILTER CARTRIDGE	10
WATER CHEMISTRY.....	11-12
REPLACING THE LED LIGHT.....	13
FREEZE PROTECTION.....	14
CLEANING YOU SPA.....	14
CARE FOR THE VINYL HARD COVER.....	14
EVERY DAY SOIL.....	14
FREQUENTLY ASKED QUESTIONS.....	15
PURGING THE PUMP.....	16
JET TOOL.....	17
TROUBLESHOOTING GUIDE.....	17
GLOSSARY OF TERMS.....	18
OZONE (OPTIONAL EQUIPMENT).....	19
WARRANTY.....	20

Important Safety Instructions

When installing and using this electrical equipment, basic safety precautions should always be followed, including the following:

READ AND FOLLOW ALL INSTRUCTIONS

1. **WARNING:** To reduce the risk of injury, do not permit children to use this product unless they are closely supervised at all times.
2. **WARNING:** A wire connector is provided on this unit to connect a minimum 6 AWG (4.11 mm) solid copper conductor between this unit and any metal equipment, metal enclosures of electrical equipment, metal water pipe, or conduit within 5 feet (1.5m) of the unit.
3. **DANGER RISK OF INJURY:** (For cord and plug connected units):
 - a. Replace damaged cord immediately
 - b. Do not bury cord
 - c. Connect to a grounded, grounding type receptacle only.
4. **WARNING:** (For units with a Ground Fault Circuit Interrupter (GFCI): This product is provided with a Ground Fault Circuit Interrupter GFCI on the end of the spa's power cord. This GFCI must be tested before each use. With the product operating depress the "test" button on the GFCI the spa should not operate. Depress the "reset" button on the GFCI. The product should now operate normally. If the spa fails to operate in this manner, there is a ground current flowing indicating a possible electric shock. Disconnect the power until the fault has been identified and corrected by a certified licensed electrician.
5. **DANGER RISK OF ACCIDENTAL DROWNING:** Extreme caution must be exercised to prevent unauthorized access by children. To avoid accidents, ensure that they cannot use this spa unless they are supervised at all times. For additional protection, use a cover which is classified by the Underwriters Laboratories Meeting ASTM F1346-91 requirements. The cover supplied by the manufacturer meets these requirements.
6. **DANGER RISK OF INJURY:** If your spa is equipped with suction fittings, the suction fittings in this spa are sized to match the specific water flow created by the pump. Should the need arise to replace the suction fittings or the pump, be sure that the flow rates are compatible. Never operate spa if suction fittings are broken or missing. Never replace a suction fitting with one less than the flow rate marked on the original suction fitting.
7. **DANGER RISK OF ELECTRIC SHOCK:** Install at least 5 feet (1.5m) from all metal surfaces. As an alternative, a spa may be installed within 5 feet (1.5m) of metal surfaces if each metal surface is permanently connected by a minimum 6 AWG (4.11 mm) solid copper conductor to the wire connector on the terminal box that is provided for this purpose.
8. **DANGER RISK OF ELECTRIC SHOCK:** Do not permit any electric appliance, such as light, telephone, radio, or television, within 5 feet (1.5m) of a spa.
9. **WARNING TO REDUCE THE RISK OF INJURY:**
 - a. The water in a spa should never exceed 104°F (40°C). Water temperatures between 100°F (38°C) and 104°F (40°C) are considered safe for a healthy adult. Lower water temperatures are recommended for your children and when spa use exceeds 10 minutes.
 - b. Since excessive water temperatures have high potential for fetal damage during the early months of pregnancy, pregnant or possibly pregnant women should limit spa water temperatures to 100°F (38°C).
 - c. Before entering spa, the user should measure the water temperature with an accurate thermometer since the tolerances of water temperature-regulating devices vary.
 - d. The use of alcohol, drugs, or medication before or during spa use may lead to unconsciousness with the possibility of drowning.
 - e. Persons suffering from obesity or with a medical history of heart disease, low or high blood pressure, circulatory system problems, or diabetes should consult a physician before using a spa.
 - f. Persons using medication should consult a physician before using a spa since some medication may induce drowsiness while other medication may affect heart rate, blood pressure, and circulation.
10. **WARNING:**
 - a. People with infectious diseases should not use a spa or hot tub.
 - b. To avoid injury, exercise care when entering or exiting a spa or hot tub.
 - c. Do not use a spa or hot tub immediately following strenuous exercise.
 - d. Prolonged immersion in a spa or hot tub may be injurious to your health.
11. **Caution:** Maintain water chemistry in accordance to manufacturer's instructions.

(Safety instructions continued on next page)

Your spa can be a source of great pleasure. It offers healthful stimulating recreation and is a delightful fun center for you, your family and friends. However, it contains large quantities of water and is deep enough to present inherent dangers to life and health unless the following safety rules are strictly observed.

12. **Never permit the spa to be used unless it is attended by at least one person other than the bather.**
Someone should be present to lend assistance if the bather should be in trouble due to injuries, cramps, or drowning, especially in case of children.
13. **Always use care in and around your spa.**
The spa has many rigid, unyielding parts and many areas that become wet and slippery; these are all potentially dangerous when rough play is permitted or if care is not used, particularly when entering or leaving the spa.
14. **Keep the water sanitary and healthful at all times.**
Your filter system will remove suspended particles from the water. Regular application of spa chemicals in proper quantities will destroy harmful bacteria and prevent formation of algae. Your surface skimmer will remove insects, leaves, and other debris from the water surface. Unsanitary water is a serious health hazard.
15. **The water in your spa must NOT be warmer than 100°- 104° F (38°-40°C).**
Always keep an accurate thermometer in the water because your spa's thermostat may be in error. Use a high quality, shatterproof thermometer with increments of one degree or less.
The National Spa and Pool Institute consider a temperature of 100°F (38°C) safe and comfortable for a healthy adult. Most healthy adults can enjoy this water temperature for as long as desired, although it may raise the body temperature to the water temperature and eventually become uncomfortable (like a fever). At higher water temperatures the soaking time should be shorter; never soak for more than 20 minutes when the water temperature is 102°F (39°C) or higher. If you are planning a long rest in the spa, lower the water temperature closer to normal body temperature, about 99°F (37.2°C). Some people find even lower water temperatures relaxing and pleasing. Try different water temperatures in the 98°-102°F (36.6°-39°C) range until you find what temperatures suit you best.
16. **Hot water can raise the body temperature high enough to cause heat stroke.**
This can be fatal even to healthy adults. If you have any questions about your own fitness or whether you should soak in the spa, check with your physician.
17. **Prolonged immersion in hot water may induce hyperthermia.**
Hyperthermia occurs when internal body temperature reaches a level several degrees above the normal body temperature of 98.6°F (36.6°C). The symptoms of hyperthermia include: (1) dizziness, (2) fainting, (3) drowsiness, (4) lethargy, (5) increases in the internal body temperature. The effects of hyperthermia include: (1) unawareness of impending hazard, (2) failure to perceive heat, (3) failure to recognize the need to exit spa, (4) physical inability to exit spa, (5) unconsciousness resulting in danger of drowning.
18. **WARNING: The use of alcohol, drugs, or medication can greatly increase the risk of fatal hyperthermia in hot tubs or spas.**
Despite the popular image of people in spas drinking wine or other alcoholic beverages, DO NOT use alcoholic beverages before or during spa use. Alcohol is a depressant which causes slowed reflexes and drowsiness, especially in conjunction with the relaxed soaking in hot water. This can lead to sleep or unconsciousness and possibly result in drowning. Using your spa with other people who are also drinking is not a preventative measure since they are likely to become similarly affected by the combinations of alcohol and hot water soaking.
Soaking in hot water causes changes in the circulatory system, such as enlargement of blood vessels near the skin. Therefore, people with a medical history of heart disease, circulatory problems, diabetes, high or low blood pressure should check with their physician before using spas. Additionally, people taking medications causing drowsiness, such as tranquilizers, narcotics, antihistamines, or anticoagulants should not use spas without asking their physician.
19. **If equipped, broken or missing drain covers should be replaced immediately.**
Accidents can occur when long hair or a body part is trapped by suction from a drain or outlet whose cover is broken or removed. Children are particularly vulnerable, and they should be warned against danger.
20. **WARNING: Do not use electrical appliances in or around your spa. Do not use glass or other breakable items in or around your spa. Do not remove spa cabinet panels and attempt to make repairs. Do not attempt electrical repairs. Retain a certified licensed electrician.**
21. **This spa is for residential use only.** It is not intended for commercial use.

SAVE THESE INSTRUCTIONS

Selecting a location

WARNING! DO NOT STORE SPAS OUTDOORS WITHOUT PROPER WATER LEVEL.

A spa stored outside in direct sun, without proper water level, uncovered or under a tarp/cover, can accumulate temperatures that will damage the spa, its components and void the warranty. Only store an empty spa indoors or in the shade.

Will your electrical cord reach an outlet?

Locate your spa so that the GFCI plug and cord will reach a standard 120 volt / 15 amp outlet*, but not closer than 5 feet (1.5m). Do not use an extension cord. Use of an extension cord will void your warranty. To extend the power cord, with a Philips screw driver remove the access door shown in Fig 1A, locate the coiled GFCI cord, uncoil and extend the cord as shown in Fig 1A. Ensure that the cord is routed through the notch at the lower center of the opening before reinstalling the access door. Do not connect to the outlet until the spa is filled with water (see page 8).

Is permitting required for construction, electrical, or barriers?

Most cities and counties require permits for exterior construction and electrical circuits. Some areas have codes requiring barriers such as fencing and/or self-closing gates on property to prevent unsupervised access to the property by children. Your local code enforcement department can provide information on which permits may be required and how to obtain them before delivery of your spa.

Is the support surface adequate to support the weight of the spa?

Provide a solid flat level load-bearing surface. The surface must provide a solid foundation with a minimum load bearing capacity of 125 pounds per square foot (610 kg per square meter). Concrete slabs and decks must be designed to support this weight.

Warning! Your spa is constructed of a very resilient and flexible polymeric material. It is designed to flex as much as 2 inches (5cm) without damage. However, overfilling the spa and/or installing on a non-level surface for extended periods of time can permanently distort the original shape of your spa, cause structural damage, effect the sealing of the cover and void your warranty.

Is the support surface impervious to water and adequate to handle water overflow?

The surface must be suitable for a wet location and allow for adequate drainage for overflow water.

Are there considerations for limiting access by children?

Childproof Your Spa. Plan for limiting access by children. Take precautions such as self-closing, locking gates, access doors, fencing and other child barriers, as dictated by the site.

Are there overhead electrical lines?

Do not locate your spa under overhead power lines or in near proximity to existing buried or exposed electrical circuits.

Is there adequate room to access the service door, drain, filter and insulating cover removal?

If you are installing your spa near a wall or with any type of structure on the outside, such as a gazebo, remember to allow access for service and insulating cover removal.

Are there any privacy considerations?

*To avoid nuisance circuit breaker tripping, it is best to use an outlet on a circuit which does not supply power to any other major running appliance. This can be checked by turning off the circuit breaker that supplies the intended outlet and verifying that no other electrical devices no longer work, such as a refrigerator, dishwasher, washing machine, coffee maker, hair dryer, etc.

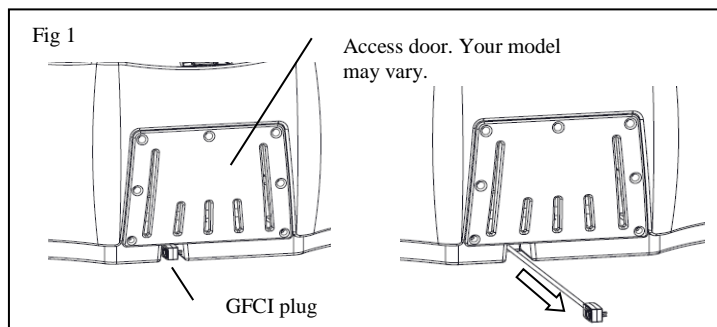

Spa Cover Installation

WARNING! AVOID DROWNING RISK

- Failure to follow instructions may result in injury or drowning.
- Non-secured covers are a hazard.
- Keep children away. People or objects cannot be seen under the cover.
- Because of entrapment possibility, remove cover completely before entry of bathers.
- Excess weight can break the insulating foam, bend the steel reinforcement and damage the cover. Do not allow people or pets to stand or sit on the cover. Do not allow loads such as snow, leaves or anything else to accumulate on the cover. Do not use the cover as a table.

Caution, to avoid damage to the cover always remove the cover while adding chemicals to the spa water. This will prevent damaging chemical vapors from being trapped under the spa cover. These vapors can prematurely damage the cover material and void the warranty.

When properly installed, the cover supplied with your spa meets the Manual Safety Cover requirements of ASTM F1346-91.

If you are installing your spa near a wall or with any type of structure on the outside, such as a gazebo, remember to allow access for cover removal.

To deter entrapment by somebody slipping under the cover, ensure that all latches supplied with the cover are securely screwed to the cabinet, straps are inserted into the latches, the latches are locked and the key is kept in a secure location.

Keep the spa covered when not in use to deter entry by unauthorized persons, reduce the loss of heat, and keep out rain and to keep foreign materials from settling in the water.

Follow these steps to properly install the cover.

1. Place the spa cover on top of the spa. Ensure the cover flaps and straps are not under the cover. Ensure the cover is properly seated in its final position.
2. Each strap is supplied with a cabinet latch snapped in place. Leave the cabinet latches at the end of the straps, but remove the bag containing the screws and while lightly pulling downward on a strap, mark the center bottom of the latch (fig 1). A piece of tape may be a good method to do this. Mark each remaining strap in the same way.
3. Remove the strap by pinching the two barbs of the strap as indicated (fig 2).
4. Hold the cabinet latch on the mark and using a Phillips screwdriver, drive three screws through the holes in the cabinet latch and into the outside of the spa (fig 3).
5. While the spa is not in use place the cover on top of the spa and snap all straps into the cabinet latches. To further protect against entry, lock each latch by quarter turning the key clockwise (fig 4). Store the key in a secure place.

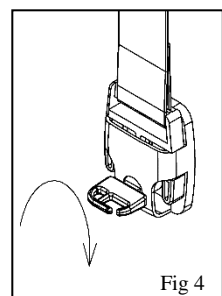
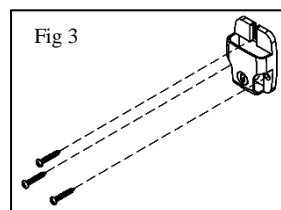
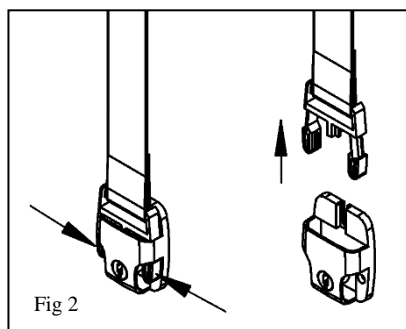
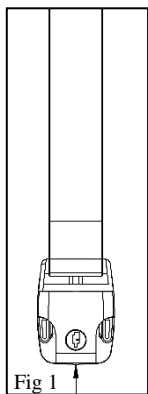

Filling Your Spa

Warning! Your spa is constructed of a very resilient and flexible polymeric material. It is designed to flex as much as 2 inches (5cm) without damage. However, overfilling the spa and/or installing on a non-level surface for extended periods of time can permanently distort the original shape of your spa, cause structural damage, effect the sealing of the cover and void your warranty.

Remove the access door (Fig 1) and ensure the drain valve is closed and the cap is secure (fig 2).

Place a garden hose into filter area (Fig 3) and fill the spa with cold (never warm or hot) water 6 to 8 inches (15 to 20 cm) below the top edge of the spa (Fig 2.1). If there is not enough water in your spa, the pump may suck air into the plumbing system thereby damaging the pump or heater, and void the warranty. Do not overfill, as the spa's water level will rise as each person enters the spa. Always keep the spa water level above the jet openings.

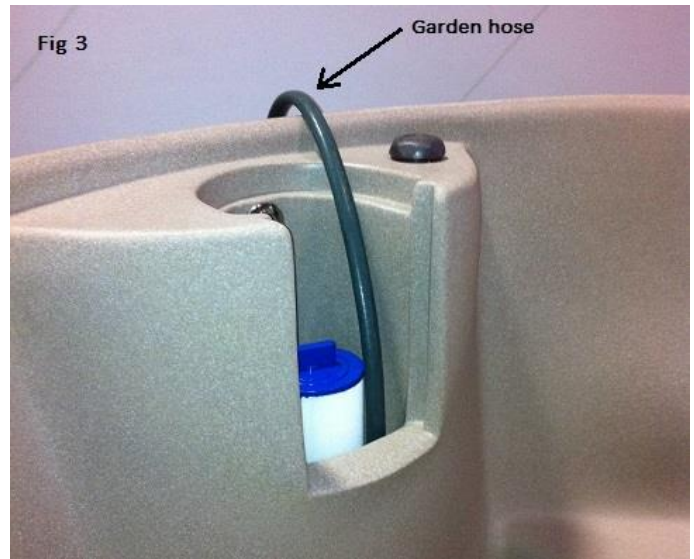
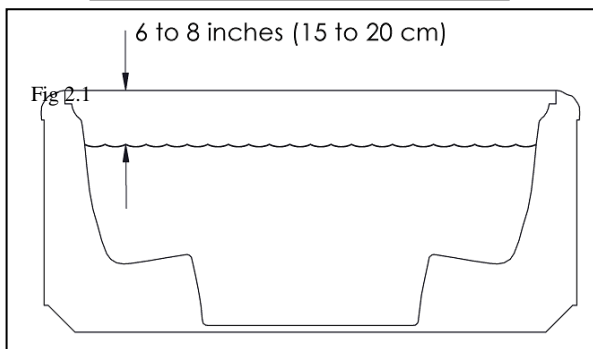
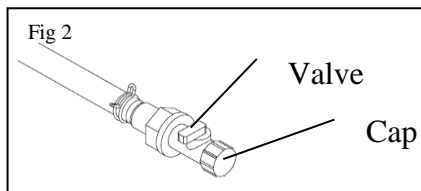

Draining the spa

Draining your spa on a regular basis rids the spa of dissolved solids and protects your spa equipment from the effects of residual calcium hardness and total alkalinity problems. Depending upon usage, it may be as often as every three months.

To drain the spa follow these steps:

1. Turn power off to the spa.
1. Remove the access door (Fig 1) and locate the drain valve (Fig 2).
2. Ensure that the drain valve is in the off position (as shown in figure 2). Remove the cap (Fig 2) and attach a standard garden hose to the drain valve (Fig 4).

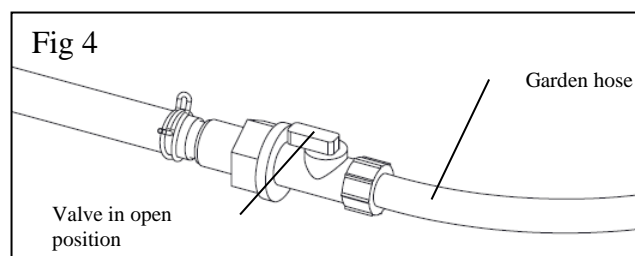

3. Route the garden hose to a sewer drain capable of safely assimilating 300 plus gallons of water which may contain both unsanitary contaminants and chemical residue. Open the drain valve (as shown in Fig 4). The spa drains slowly.
4. The spa can only drain to the lowest jet. It may be necessary to manually remove the remaining water.
5. Before refilling your spa, ensure that the drain valve is in the off position and the cap is secured (Fig 2).



System Operation



Initial Start-Up



From the moment your spa is plug in, it is automatically pre-set to operate until it reaches 100°F (38°C). This process could take up to 20 hours depending on the initial water temperature. The spa is also preset to filter the water for 1 hour per day (30) and the clock starts the second you plug it in. If after the first 7 minutes water is not flowing from the jets you may need to purge the pump. Please see page 16.

Temperature Adjustment 60°F-104°F (15°C-40°C)

When either of the Accu-temp pads   are pressed once, the LCD will display the temperature which has been set. Each time either one of these pads are pressed again, the temperature will change by 1°. After 5 seconds, the LCD will automatically display the current spa temperature.





Jets. Press the  pad to run the pump on and off. If left running, the pump will automatically turn off after 15 minutes.

Adjustable LED Light

To turn the light on, press the  button. Press again to turn it off. To adjust the color modes, press the  button immediately after turning it off. The light will come back on in a new color mode. Each time you repeat this procedure, the light will cycle to a new color mode, as shown below. If left on, the light will automatically turn off after four hours.

1. Color wheel. The light will slowly blend cycle through the colors.
2. Aqua white.
3. Light blue.
4. Violet.
5. Dark blue.
6. Light green.
7. Dark green.
8. Red.
9. Step sequence through the colors.
10. Very slow color wheel.
11. Back to #1.

Spa Water Maintenance. This function enables you to program the amount of water filtration time.

Press  or  and then  to enter the programming mode. Once in the programming mode press  or  to select the filtration time.



00 In this mode there is no additional filtration.

30 In this mode the water will be filtered for 1 hour every day.

60 In this mode the water will be filtered for 2 hours every day.

To exit press .

Standby Mode

This function allows you to disable the equipment when the filter needs to be serviced without disturbing the already programmed filtration time. Press  or  and then  to enter the standby mode. All spa functions are disabled except for freeze control. To exit from standby press any button.

Display Messages:

OH "Overheat" (spa is deactivated)

DO NOT ENTER THE WATER. If the spa water has reached 108°F (44°C), remove the spa cover to cool the water. The spa will remain shut down until the water and the heater sensor cools to 104°F (40°C). At that point press any button to reset the spa. If the spa will not reset, shut off the power to the spa and call your dealer or service organization.

SN "Non Functional High Temp Sensor" (heater is deactivated)

Open sensor. Call your dealer or service center.

Air Injection Venturi Adjustment

Air injection into the massage jet water flow may be controlled by turning the venturi dials located on either side of the spa.



Surface Skim Filter

The spa's automatic surface skim filter is designed to remove floating debris and contaminants such as body lotions by drawing water through a specially formulated filter cartridge. It is critical that this element be routinely cleaned.

Cleaning the Filter Cartridge

To clean the filter cartridge follow these steps:

1. Turn off power to the spa. Never operate the spa without the filter cartridge in place. It is difficult to remove the filter cartridge while the water is flowing. Also, there is a risk that debris may be drawn into the plumbing system, damage the pump and void the warranty.
2. Remove the end nut by turning it counter clockwise (Fig 5).
3. Pull up filter cartridge (Fig 5).
4. Remove the cartridge and thoroughly rinse with a garden hose until the cartridge is free of dirt and debris.
5. Return the clean cartridge to the filter well and turn the end nut clockwise until snug.

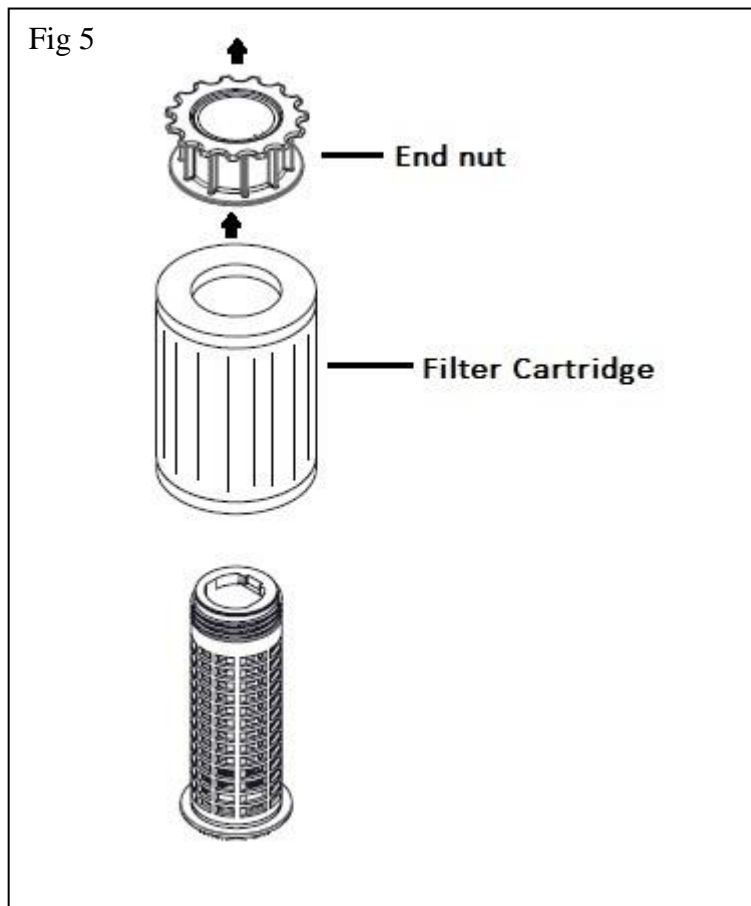

Spa water chemistry (or water balance) affects the safety of your equipment as well as the appearance of your spa water. Water balance has five factors: pH, total alkalinity, calcium hardness, temperature and total dissolved solids. pH is the most critical but total alkalinity and calcium hardness must also be watched closely. Low calcium hardness can lead to corrosion of equipment, while high calcium hardness can lead to scaling, cloudy water and staining. Water temperature should never exceed 104°F (40°C), and total dissolved solids should be kept below 1500 PPM. Algicidal and sanitizing chemicals are either alkaline or acid. Sodium and calcium hypochlorites are alkaline. Chlorine gas and practically all other dry chlorine spa products are acid. On the market are a number of bromine sanitizers. Bromines are usually preferred since they don't emit a strong chlorine odor.

SEE YOUR SPA WATER EXPERT FOR ADDITIONAL INFORMATION

Damage due to improper chemistry will void warranty

1. Check and adjust water conditions. You must maintain proper chemical balance to insure safe sanitary conditions and to prevent your spa from becoming a breeding place for bacteria. This is done by:
 - A. Test daily and maintain pH between 7.2 and 7.8. Adjust if necessary, above 7.8 use pH decrease, if below 7.2 use pH Increase. Improper pH can damage spa finish, equipment, cause eye irritation and chemical loss. Use dosage according to manufacturer's label.
 - B. Test alkalinity and maintain at 80 ppm to 140 ppm. Adjust if necessary, above 140 ppm use pH Decrease, if below 80 ppm use Total Alkalinity Control. Use dosage according to manufacturer's label.
 - C. Test daily and maintain proper sanitizer level. It's recommended to use bromine sanitizer and maintain bromine at 3.0
5.0 ppm. Typically two or three bathers relaxing in an average spa with 103°F (39°C) temperature will consume all the bromine sanitizer in about twenty minutes. Therefore, prolonged or heavy use may require additional bromine to maintain safe sanitary conditions.
 - D. "Shock" (with a non-chlorine shock) once a week and after each water change. Do not use spa until the bromine residual has dropped to less than 5.0 ppm. NOTE: Improper pH will cause early corrosion to your pump. Corrosion is not handled under any warranty.

SPA MAINTENANCE SCHEDULE

DAILY

Test and maintain pH: Ideal range 7.2 - 7.8b.

Test and maintain bromine: Ideal range 3.0 - 5.0 ppm.

WEEKLY

Test and maintain alkalinity 80 - 140 ppm. Shock with a non-chlorine shock.

Add Spa Clear.

MAINTENANCE

Add defoamer as needed.

Inspect filter cartridge every 2 weeks and clean when needed.

It is recommended that the spa be drained regularly depending on its size, location and the frequency of use.

1. Clean filter and cartridge periodically according to manufacturer's instructions.
2. Keep the spa covered when not in use to reduce the loss of heat and to keep out leaves, dirt, and other foreign materials from settling in the water.
3. Since the water capacity of your spa is far less than that of a swimming pool, the chemical reaction caused by the presence of one or more persons in the spa is more rapid and pronounced. For these reasons, it is important to frequently check the bromine level, the pH level and total alkalinity of water then add the prescribed chemicals as necessary to maintain the proper chemical balances.
4. If questions or doubts arise regarding quantities and timing of chemical applications to your spa, contact your spa dealer who can assist you in prescribing the correct program for your spa.
5. Store all chemicals in a cool dry place and in such a manner as to prevent contact by children and pets.
6. When adding chemicals to your spa water, add to the center of the spa with the pump operating. Never add chemicals to unheated water as this will affect chemical action.

Replacing the LED light.

1. Turn off power to the spa.
2. Using a Philips screwdriver, remove the access vent located on the outside of the spa, directly behind the filter (Fig 7.1).
3. Reach in and turn the white holder counter clockwise and gently pull it, with the attached wires, out the access hole (Fig 7.2).
4. Pull the LED light out of the light socket (Fig 7.3).
5. Install a new LED light, attach the white reflector turning clockwise and reattach the access vent with the screws.

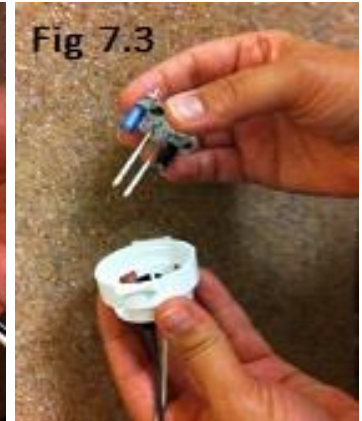

DO NOT ALLOW THE SPA TO FREEZE

Caution, any damage caused by improper winterizing will void the warranty. You may want consider contacting a spa professional for winterizing service.

If the spa is to be stored or transported in temperatures of 32°F (0°C) or lower, it is critical that the unit be fully winterized.

To winterize the spa follow these steps:

- 1 The spa itself must be completely drained of water. See page 8 for draining instructions.
- 2 The drain valve must be in the open position and the cap removed.
- 3 Drain the pump by removing the pump wet end drain plug (Fig 6.1). Leave this plug out until it is time to refill the spa.

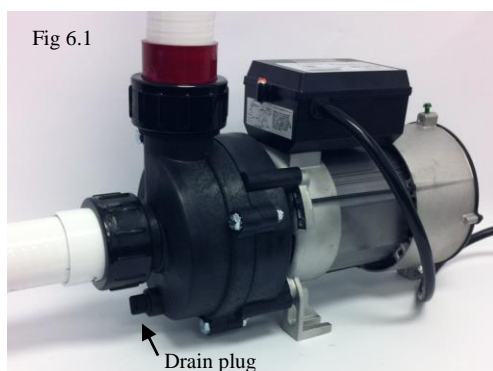

- 4 The filter cartridge must be removed, dried and stored. See page 10 for instructions for removing the filter cartridge.
- 5 The spa must be inverted (turned upside down) for at least five minutes to facilitate draining of the internal plumbing.

CLEANING YOUR SPA

Do not use cleaners or compounds containing harsh abrasives. Also, avoid using heavy-duty rubbing or buffing compounds. Use a soft liquid cleaner.

CARE OF VINYL HARD COVER

Vinyl coated fabrics are perhaps the most maintenance-free fabrics ever produced and certainly will provide exceptional service life if given the proper care. Almost all vinyl manufacturers now provide information concerning the necessary cleaning procedures for their products. In reality, all care maintenance instructions are the same for all coated fabrics regardless of their manufacturing origin.

Products are now on the market which are manufactured to enhance the beauty and service life of all vinyl. However, by using methods described below with minimal care and attention, you should enjoy years of satisfaction and pride with any vinyl coated fabric.

EVERYDAY SOIL

A gentle mixture of any mild soap and warm water will generally dissipate most common soil from the surface. Using a soft cloth, wash the area to be cleaned and rinse. If stubborn dirt remains, as a stain embedded in the grain of the vinyl, use a soft brush, and if necessary, a touch of cleaning powder. In both situations, rinse and dry with a soft cloth.

Frequently Asked Questions

1. **Why does my spa not shut off?** Your spa is designed to run from the time you plug it in to run until it reaches your desired temperature. Once desired temperature is reached then you can control the on/off with the buttons on the top control. **For example: On the initial startup the spa will run for approximately 18 hours to reach 100°F (38°C). At that point the spa will shut off, and then the spa will maintain your desired temperature settings. Keep in mind that anytime power is disrupted from the spa, the spa will reset itself and run until it reaches the spa's default settings.**

2. **Why does my spa turn on late at night?** The spa is designed to filtrate every 12 hours. The clock starts the second you plug it in. Recommend unplugging and plugging back in between 7 and 8. This means the spa will come on every 12 hours at the designated time and filter the amount of time you have it set for.

3. **Why is my spa hotter than it is set for?** If your spa is set for 101°F (38°C) but it reads 103°F (39°C) most likely your filter cycle is set too high. Adjust your filter cycle down to the next lower setting or **F2**. Remember, when the spa is running to filtrate it is also heating.

4. **Why is my spa not heating?** All spas heat at approximately 1.5° F (1°C) per hour. If your water temperature is 70°F (21°C) when you first fill your spa it will take approx. 20 hours to reach 100°F (38°C). **Remember, it is imperative to keep your safety cover on and the air control valves turned off while heating.**

5. **How many gallons does my spa hold?**

Model	AR-200	AR-300	AR-400	AR-500	AR-600
<small>First three characters on rating plate</small>	ECL	TRI	X4H	X5H	EZB
Gallons	180	160	190	215	240
Liters	681	598	723	806	916

6. **I see water on the floor. What does this mean?** The cover can accumulate condensation between the seams and run down the sides of the spa. You can verify that water is coming from the cover by squeezing the seam, or by repositioning the cover so that the seam is on a different side. This only occurs when the temperature and humidity are at certain levels.

7. **What do I do if I cannot fix a problem?**
Contact the dealer from whom you purchased the spa.

PURGING THE PUMP

Sometimes after a water change (draining and refilling the spa), or initial start-up of the spa, there is no water flowing from the jets. You may hear the pump operating or even see the shaft of the pump motor turning, but have no water flowing from the jets. In addition to no flow out of the jets, you may even see an error message dr, dY, HH, OH, HL, or LF. All of these error messages can be caused by a lack of water flow. When this happens there is probably an air-lock in the pump. This air-lock must be purged from the plumbing for the pump to operate normally.

To purge the pump, please follow these steps:

1. Ensure the spa is filled 6 to 8 inches (15 to 20 cm) below the top of the spa.
2. Remove the access panel to expose the water pump.

The pipes entering and leaving the pump are connected with large plastic unions. To purge the air from the pump, one of these unions will be slightly loosened.

3. Place a towel under the union to be loosened.
4. Using large pliers, slightly turn the union nut counterclockwise (Fig 8). This will produce a faint hissing sound of the trapped air escaping the pump. This will be followed by a small squirt of water which signals it is time to close the union by turning it back (clockwise). Do not over tighten the union. It is designed to be hand tight.

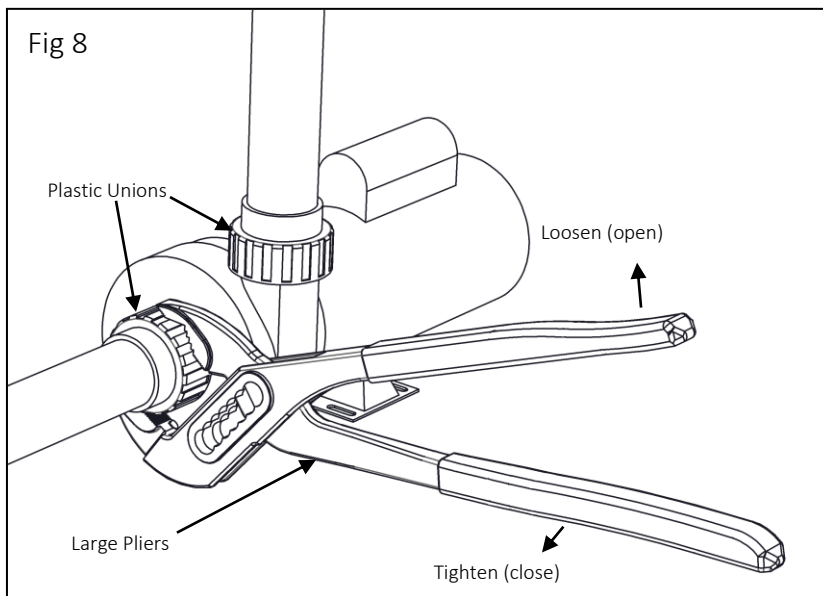

Jet Tool

This wrench is used to tighten the small 2 inch (5cm) diameter jets when needed.

To tighten the jets, insert the hex portion of the wrench into the hexagon hole at the base of the jet and turn clockwise. Do not over tighten.

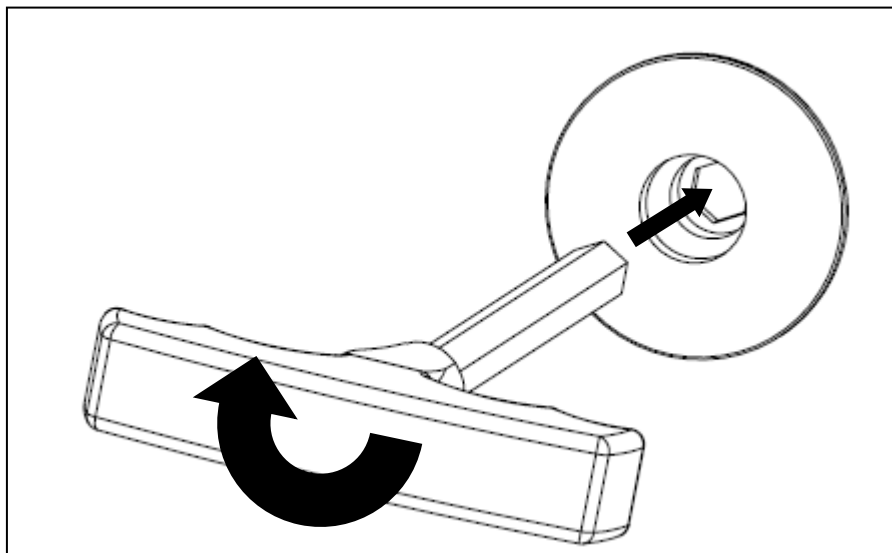

Troubleshooting Guide

SITUATION	PROBABLE CAUSE	ACTION
NO HEAT OR HEAT TOO LOW	Operating while spa cover is open.	Ensure that spa cover is properly closed.
	Dirty filter	Remove filter cartridge and clean.
JETS WON'T COME ON	No power to spa control.	Check the GFCI plug, circuit breaker and/or disconnect switch.
NO CONTROL DISPLAY OR FUNCTIONS	No power to spa control.	Check the GFCI plug, circuit breaker and/or disconnect switch.
LOW WATER FLOW	Dirty filter.	Remove filter cartridge and clean. Pg. 10
	Low water level.	Make sure water level in spa is correct.
NO AIR BUBBLES IN JET	Air control valve in the closed position.	Open venturi dials. Pg. 10.
SPA IS LEAKING	Spa drain valve and cap partially open.	Ensure that drain valve and cap are fully closed. Pg. 8
NO SPA LIGHT	Burned out bulb.	Replace bulb. Pg. 13
SLOW WATER DRAIN	Drain valve not fully opened.	Ensure that valve is fully open. Pg. 8
	Dirty filter.	Remove filter cartridge and clean. Pg10
	Kinked garden hose	Ensure drain hose is not kinked and is in a downhill direction.
NO WATER FLOW FROM JETS	Air lock in pump	Purge the pump. Pg. 16

Venturi dials

Mounted on the lip of the spa or at the equipment shroud, to induce air to the jets.

BYPASS CHECK VALVE

Prevents water flow stoppage due to dirty filter.

CONTROL BOX

Basically the brain of the spa. Power is distributed to all functions of the spa, pumps, lights, heat, etc.

DRAIN VALVE

Used in the draining of the spa, looks like an outdoor faucet and fits a standard garden hose.

FILTER

The filter cleans the spa and removes particles and debris and protects the equipment from foreign substances.

FOOTWELL

The bottom of a spa where you place your feet.

GFCI PLUG

The electronic switch installed at the end of the power cord to connect to an electrical wall outlet.

HEATER The thermostatically controlled heater raises the temperature of the water to the desired degree. This is located under the control box in the equipment area.

JETS

The fittings on your spa that direct the flow of water for massaging action.

pH

Stands for "Potential for Hydrogen" This is the term used to describe the acid (low pH) or alkalinity (high pH) condition of the water. The ideal pH for spa water is 7.5.

SKIMMER The skimmer removes surface debris to the filter. The water level in the spa should be kept at the proper range for optimum skimmer operation.

TOP CONTROL PANEL

Mounted on the lip of the spa. The digital panel that controls the spas functions.

Your Spa's Ozonator (Optional equipment)

If you ordered your spa with the optional ozonator installed, you can confirm this by viewing the spa's rating plate. The rating plate is located near the floor and equipment access door. As shown below, look in the option box to confirm the ozonator has been installed. The word "OZONE" will be seen.

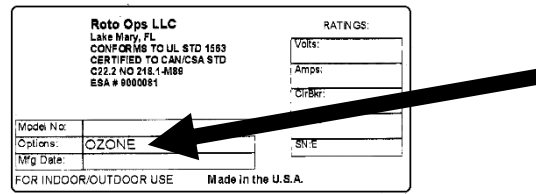

Further to verifying the ozone option is installed on your spa. If you look in the equipment compartment you will see a small black or blue box, about 2.6 inches by 3.3 inches x 1.3 inches (6.6cm x 8.4cm x 3.3cm). It will be either strapped to the plumbing or mounted on a wall, as shown below.

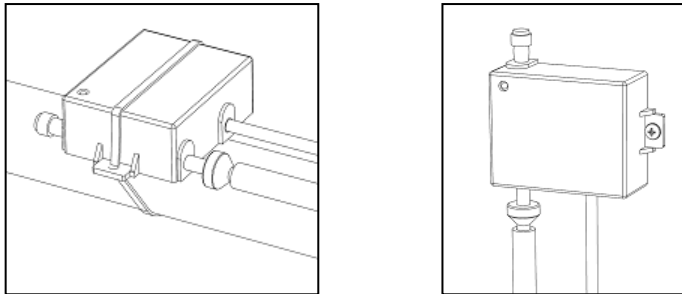

Ozone is an oxidizer used to sanitize water and air. Ozone is created naturally in the environment during thunderstorms. The electric charge created by lightning converts the oxygen in the air into ozone. Your ozonator creates ozone using the same principle. It utilizes a very high electric charge to convert oxygen into ozone. This ozone is then injected into the spa's water stream and eventually through two of the spa's jets. These jets will always produce air bubbles (however fine they may be) while the pump is operating and are not controlled by the air injector venturi dials.

The oxygen in the air is normally O₂. That is a molecule consisting of two atoms of oxygen. When exposed to a high electrical charge, a 3rd oxygen atom is added to some of the O₂, forming O₃ (ozone). The weak bond holding the third oxygen atom causes the molecule to be unstable. An oxidation reaction occurs upon any collision between an ozone molecule and a molecule of a substance that can be oxidized, i.e. bacteria, fungi, mould, yeast, viruses, and forms of metals. The weak bond 3rd oxygen atom splits off to these substances, leaving oxygen (O₂) as a by-product. During this oxidation reaction, organic molecules are changed and dissolved metals are made no longer soluble.

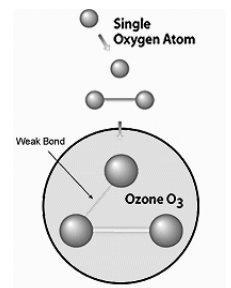

Although ozone is more effective than chlorine, chloramines and chlorine dioxide for inactivation of viruses, Cryptosporidium and Giardia; it dissipates very quickly. For this reason ozone can only be used as a secondary sanitizer, to enhance the primary sanitizer used to keep your spa safe. You must use a primary source of sanitizer which is always present in the spa water. Please see the Water Chemistry section of the spa owner's manual for further information about sanitizers.



2017 Limited Warranty

AquaRest Spas, manufactured by Roto Ops LLC, hereafter "AquaRest". This warranty is a limited warranty within the meaning of Title 1 of the Federal Trade Commission Improvement Act.

5 Year Shell – Subject to the limitations and exclusions listed herein, AquaRest warrants the shell portion of the spa, which is deemed as the rotationally molded polyethylene water holding portion of the spa, for a period of five (5) years from the original date of purchase, against loss of water through the shell due to defects in material or workmanship.

1 Year Plumbing Components – Subject to the limitations and exclusions listed herein, Aqua Rest warrants the factory installed plumbing components including the hoses, pipes, jets, air controls and unions, against leaking due to defects in workmanship or materials for a period of one (1) year from the original date of purchase.

1 Year Electrical Components – Subject to the limitations and exclusions listed herein, AquaRest warrants the factory installed electrical components to be free from defects in material or workmanship, for a period of one (1) year from the original date of purchase.

1 Year Insulating Cover – Subject to the limitations and exclusions listed herein, AquaRest warrants the factory supplied insulating cover to be free from defects in material or workmanship, for a period of one (1) year from the original date of purchase.

90 days labor – Subject to the limitations and exclusions listed herein, AquaRest will reimburse labor to perform warranty service, at AquaRest's established rates for work performed, for a period of ninety (90) days from the original date of purchase.

Extent of Warranty This limited warranty extends solely to the original purchaser of any 2016 Aqua Rest branded produced after January 1, 2016, when purchased and originally installed within the boundaries of the United States. This warranty is valid only for product produced during model year 2016. This warranty terminates upon any transfer of ownership, or if the spa is installed or relocated outside the boundaries of the United States by the original consumer purchaser prior to the expiration of the warranty period.

Limitations and Exclusions

Labor reimbursement does not include routine maintenance such as tightening jets, lubricating O-rings, changing/cleaning filters, chemical checks and adjustments, or anything else that would be considered routine maintenance.

Filters, LED lights, light bulbs, fuses and pump seals are considered wearable parts and are excluded from the warranty.

This warranty covers only the spa unit and equipment or components used in its manufacture, for the periods stated.

The purchaser is responsible for providing adequate access for the spa to be properly serviced.

This warranty shall be rendered void if the spa has not been installed in strict accordance with the owner's manual provided, including being attached to an extension cord.

This warranty shall not apply with respect to any damage caused by accident, abuse, misuse, improper installation, exposure to fire or excessive heat, acts of god, or any damage due to improperly maintained water chemistry.

Necessary maintenance or repairs on your AquaRest spa can be performed by any company. However, improper or incorrectly performed maintenance or repair that causes damage to your product may void this warranty.

Commercial & rental applications are excluded from all warranty coverage.

This warranty does not cover the rotationally molded polyethylene body for bending, twisting, warping, gloss, texture, fit or color fastness.

Aqua Rest Spas does not authorize any party, including its agents, distributors, or dealers to assume for it any other obligations or liability.

Disclaimer

TO THE EXTENT PERMITTED BY LAW, AQUAREST SHALL NOT BE RESPONSIBLE FOR LOSS OF USE OF THE SPA OR OTHER INCIDENTAL OR CONSEQUENTIAL COSTS, EXPENSES, OR DAMAGES, INCLUDING BUT NOT LIMITED TO THE REMOVAL OF ANY DECK OR CUSTOM FIXTURE OR ANY COST TO REMOVE OR REINSTALL THE HOT TUB, IF NEEDED. ALSO AQUAREST SHALL NOT BE RESPONSIBLE FOR CARTAGE, REMOVAL AND/OR RE-INSTALLATION LABOR OR ANY OTHER ASSOCIATED COST INCURRED IN OBTAINING WARRANTY SERVICE. ALL COSTS FOR REMOVAL OR REINSTALLATION OF THE SPA, OR ANY COMPONENTS, ARE THE RESPONSIBILITY OF THE PURCHASER. IN NO EVENT, WILL AQUA REST SPAS BE LIABLE FOR ANY SPECIAL OR CONSEQUENTIAL DAMAGES ARISING FROM THE USE OF THE SPA, NOR FOR INJURY TO ANY PERSON, OR ANY CLAIM FOR DAMAGES ARISING FROM THE USE, INSTALLATION, OR REPAIR OF THE SPA, INCLUDING BUT NOT LIMITED TO, WATER OR SEWAGE COST, CHEMICAL LOSS, WATER DAMAGE TO SURROUNDING AREAS, ROOMS, FURNISHING, OR LANDSCAPING. Some states do not allow the exclusion or limitation of incidental or consequential damages, so the above limitations may not apply to you. ANY IMPLIED WARRANTIES, INCLUDING THE IMPLIED WARRANTIES OF MERCHANTABILITY AND FITNESS FOR A PARTICULAR PURPOSE, ARE LIMITED TO THE DURATION OF THE APPLICABLE WARRANTY STATED ABOVE.

Some states do not allow limitations on how long an implied warranty may last, so the above limitations may not apply to you.

Warranty Performance

To make a claim under this warranty, contact AquaRest at 2452 Lake Emma Road Ste. 1000, Lake Mary, Florida, 32746, Attn: Warranty or call (888) 768-6772. You must give AquaRest written notice of any warranty claim, along with a copy of your original purchase receipt indicating the date of the purchase, within ten (10) days of the time you discover the claim.

AquaRest reserves the right to inspect the malfunction or defect on location.

AquaRest reserves the right to examine photographs prior to repair or replacement.

In the case of a shell repair or replacement, AquaRest will, at its option, repair or replace the shell portion of the spa, at the factory, at the spa installation site or at a local authorized repair station. Any freight costs incurred will be equally shared by AquaRest and the original-purchaser.

In the case of replacement components being sent before the defective component is returned, the spa owner must first provide a refundable deposit, via credit card. The defective component must be returned within 30 days to qualify for a full refund of the deposit. AquaRest cannot accept COD shipments. AquaRest will pay for shipping of the returning defective parts. The spa owner will be responsible for shipping charges of replacement part to them.

Any warranted labor reimbursement will be at AquaRest's established rates for work performed.

Trip charges, if applicable, are not covered under the labor warranty and are the responsibility of the purchaser.

Legal remedies

This warranty gives you specific legal rights, and you may also have other rights which vary from state to state.