

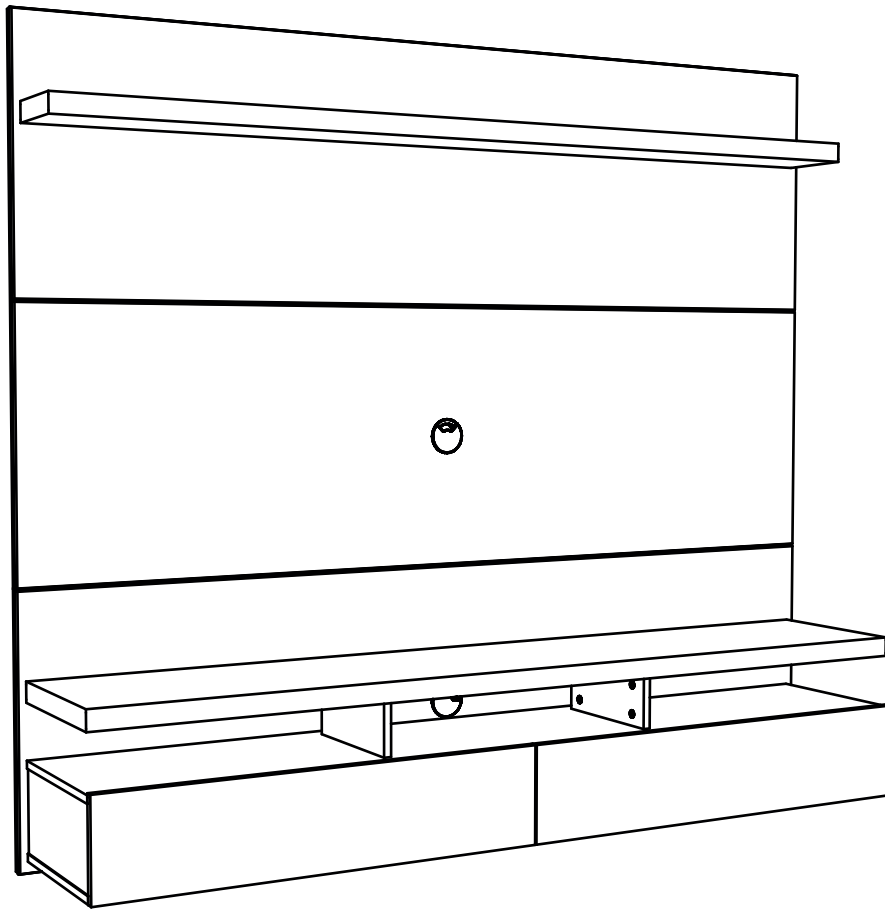

MANHATTAN  
COMFORT

ASSEMBLY INSTRUCTIONS



COD:25100

REV. 00

# IMPORTANT REMARKS



Never climb or lean on the furniture. You may suffer serious accidents.

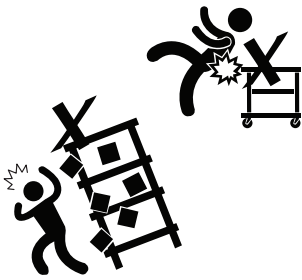

Use the packaging to cover the assembly area and separate all parts.

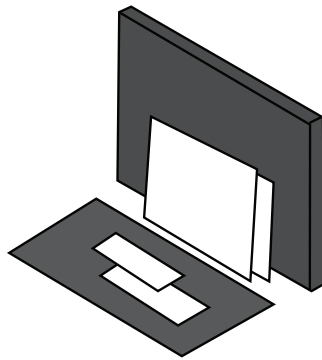

Identify the parts by observing the number printed on their edges.

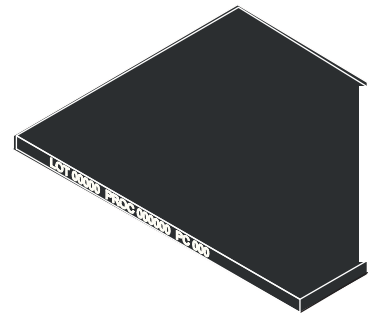

## CARE INSTRUCTIONS



Wipe clean using a damp cloth and a mild cleaner. Do not use abrasive and chemical products.



## HANDLING

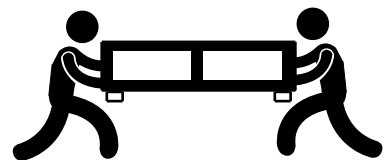

Move the piece carefully, don't drag it. Ask for someone else's help to do so.

# HARDWARE



Identify and separate the hardware used in the assembly. There's a label on each package identifying the parts and where to use them.

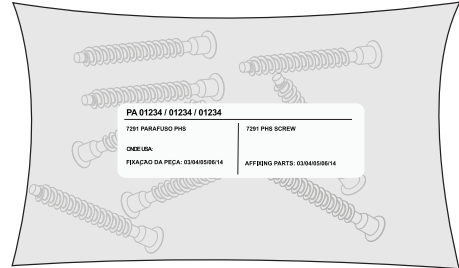

STICKER - 16x

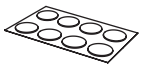

A

cod. 4462 - 4x

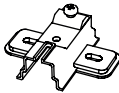

B

cod. 1668 - 25x



C

cod. 9070 - 6x

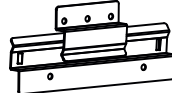

D

cod. 4157 - 9x

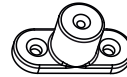

E

cod. 2511 - 4x

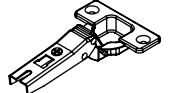

F

WIRE CHANNEL - 2x



G

cod. 0348 - 1x



H

cod. 2088 - 16x



I

cod. 0494 - 12x



J

cod. 0599 - 12x



K

cod. 0160 - 18x



L

cod. 3557 - 18x

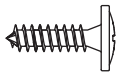

M

cod. 3706 - 18x

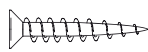

N

cod. 3527 - 20x



O

cod. 4762 - 13x

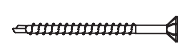

P

cod. 7519 - 16x



Q

cod. 9069 - 12x



R

cod. 4505 - 4x



S

SUPORT - 1x

SUPORTTV

T

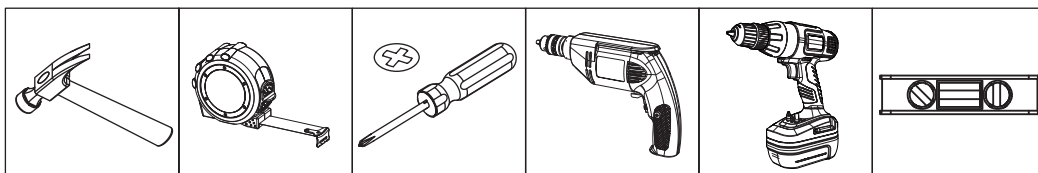

# DESCRIPTION

W:72.32 inches H:63.43 inches D: 15.27 inches  
 L:1837mm A:1611mm P:388 mm

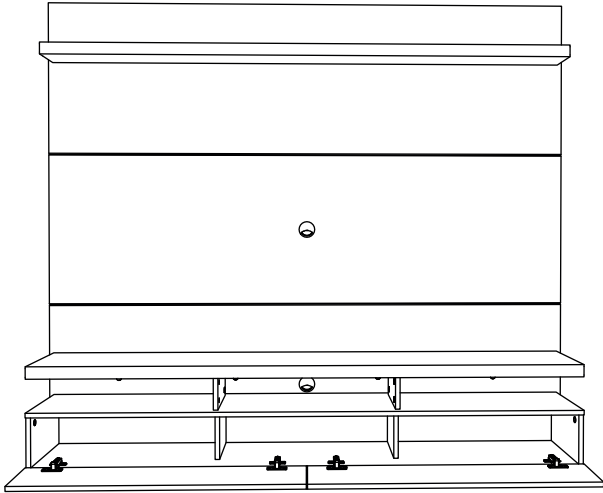

CÓD:25100			
PART	QUANTITY	DESCRIPTION	BOX
03	01	TOP SHELF	01
10	01	TOP PANEL	01
11	01	BACK PANEL	01
13	02	SIDE BATTEN	01
22	01	TOP BOARD	02
23	01	CENTER BOARD	02
24	01	BOTTOM BOARD	02
25	01	UPPER DIVIDER	01
26	01	BOTTOM DIVIDER	01
27	01	LEFT SIDE	01
28	01	RIGHT SIDE	01
32	01	DOOR	01
33	01	BACK PANEL	01
34	02	BATTEN	01

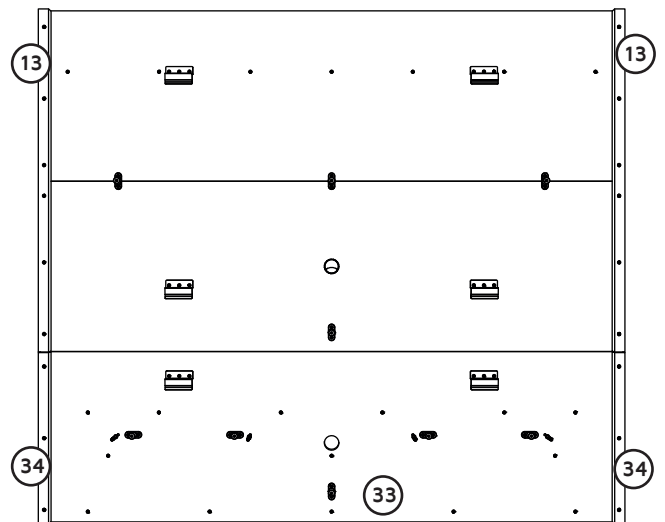
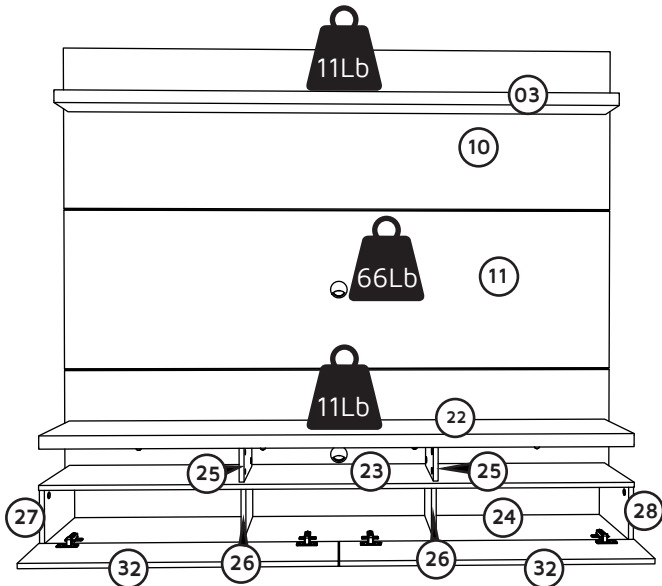





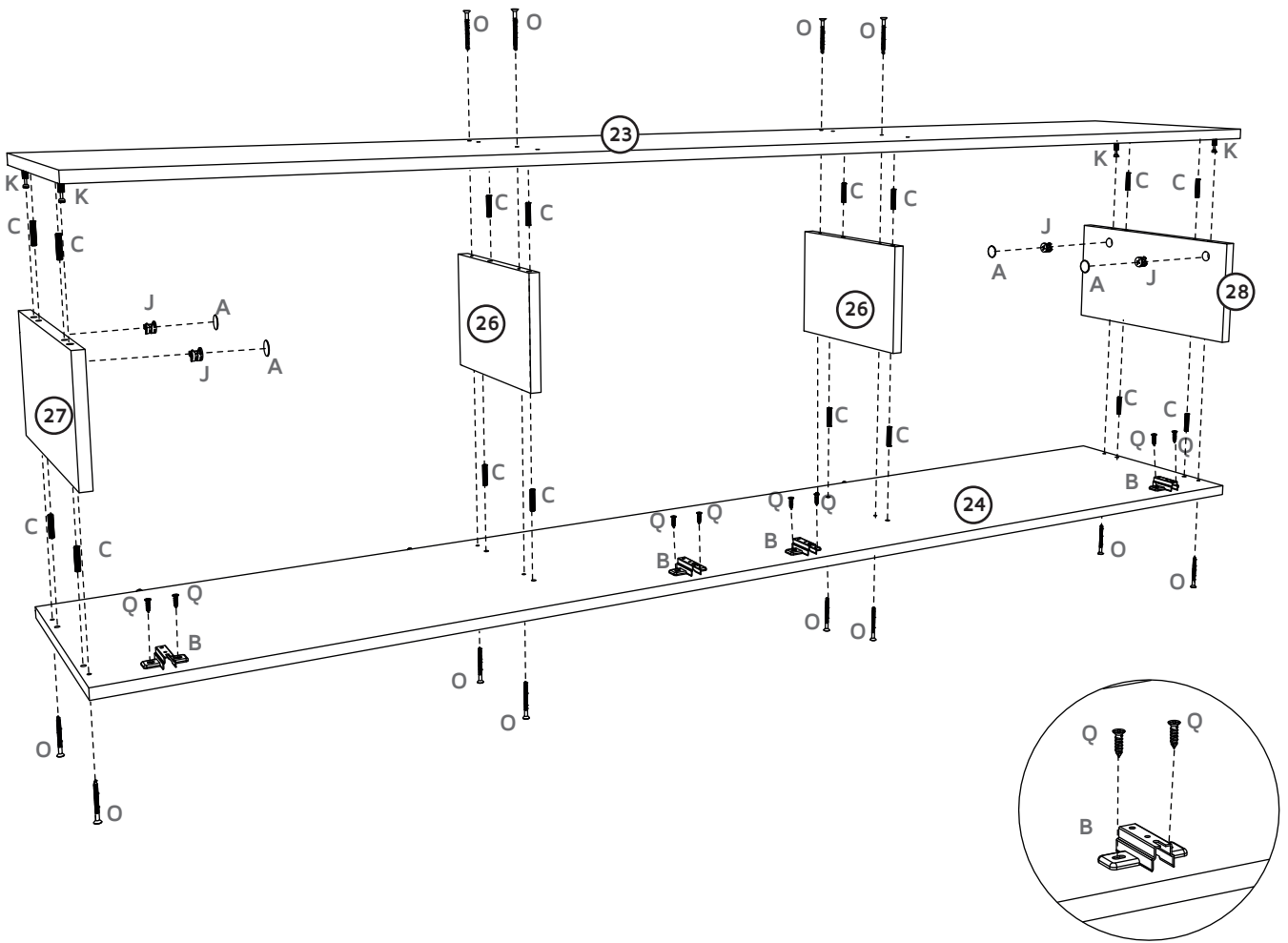



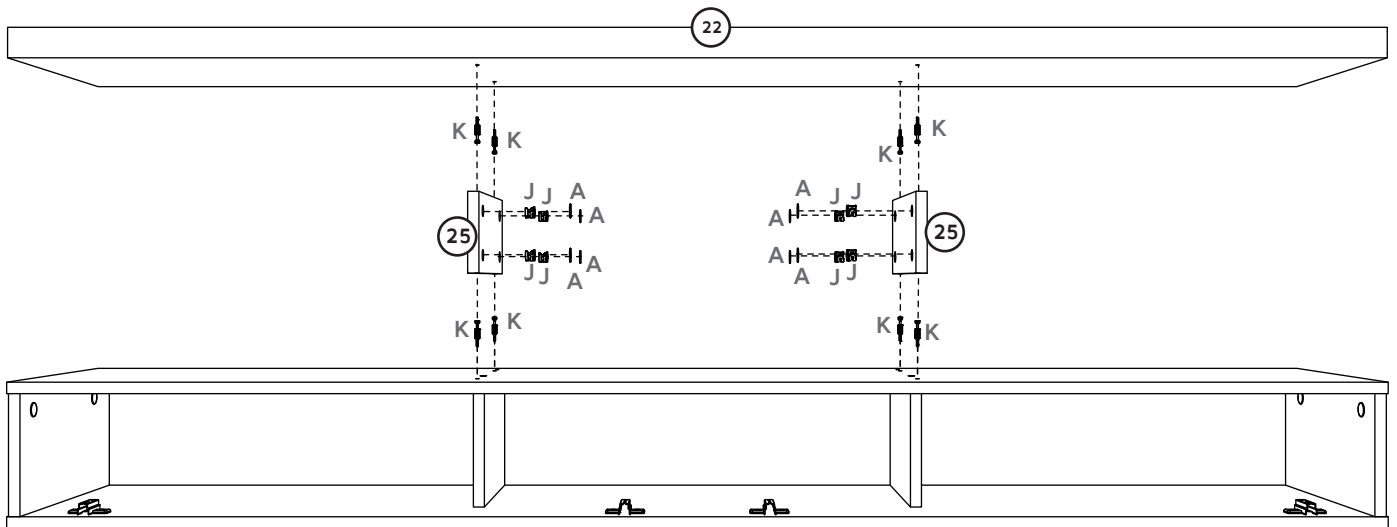

01

STICKER <b>A</b> 	COD. 4462 <b>B</b> 	COD. 1668 <b>C</b> 	COD. 0494 <b>J</b> 	COD. 0599 <b>K</b> 	COD. 3527 <b>O</b> 	COD. 7519 <b>Q</b> 
-------------------------	---------------------------	---------------------------	---------------------------	---------------------------	---------------------------	---------------------------



02



cod. 1668 <b>C</b> 	cod. 9070 <b>D</b> 	cod. 4157 <b>E</b> 	cod. 0348 <b>H</b> 	cod. 0160 <b>L</b> 	cod. 3557 <b>M</b> 	cod. 3706 <b>N</b> 	cod. 3527 <b>O</b> 	cod. 4762 <b>P</b> 
---	---	---	---	---	--	---	---	---

03

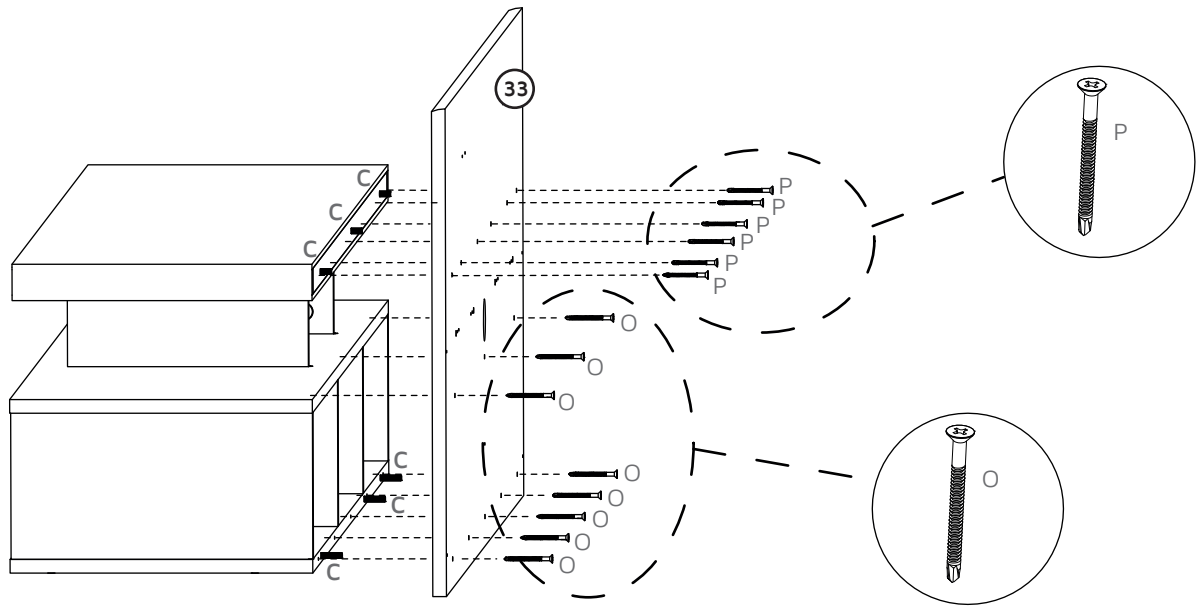

04

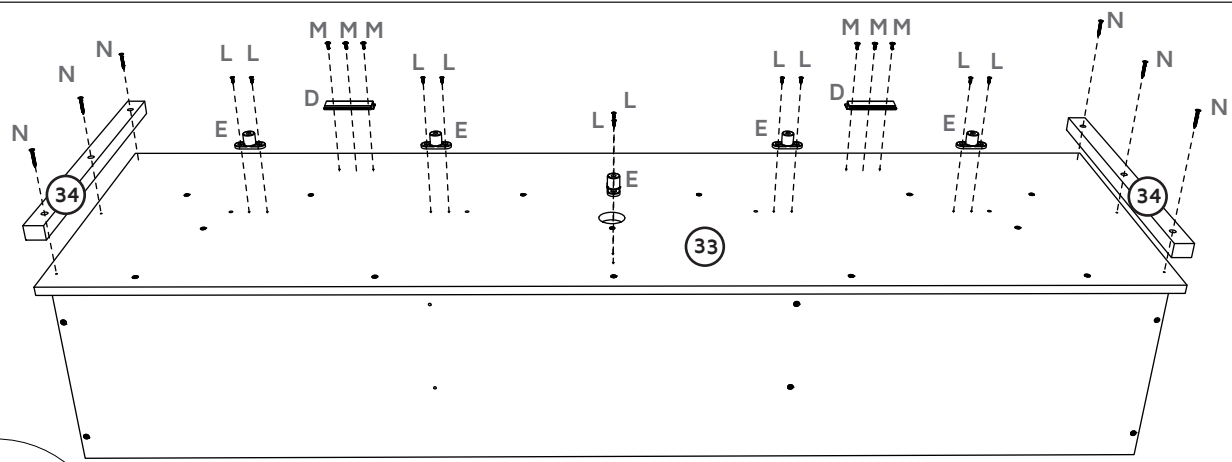



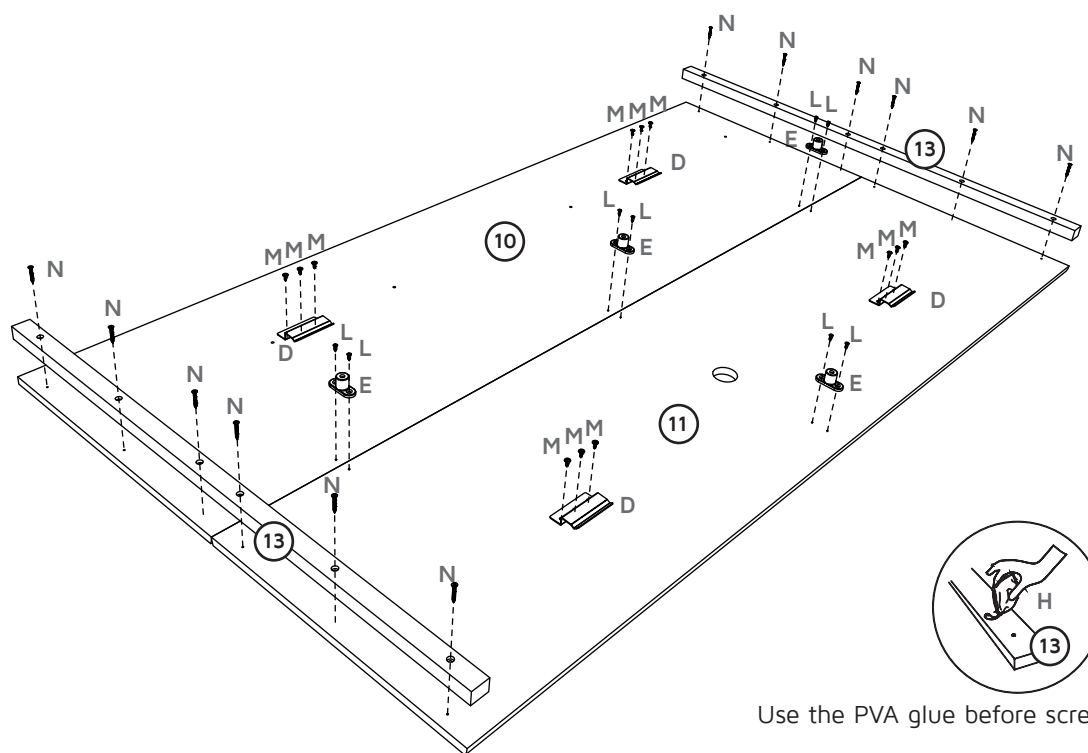

Use the PVA glue before screwing.

05



Use the PVA glue before screwing.

06



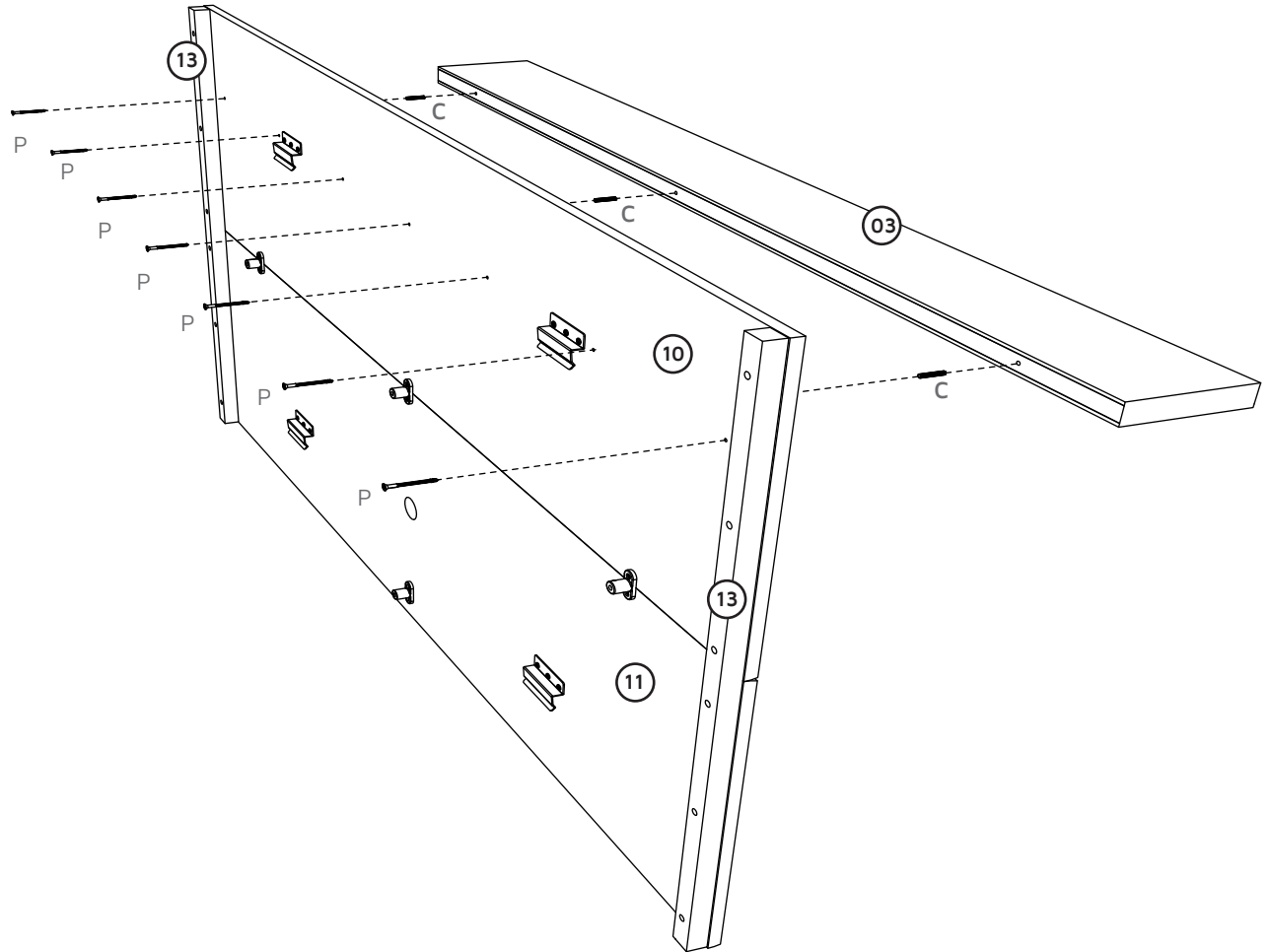

COD. 1668 <b>C</b> 	COD. 9070 <b>D</b> 	COD. 2088 <b>I</b> 	COD. 4762 <b>P</b> 	COD. 9069 <b>R</b> 
---	---	--	--	--

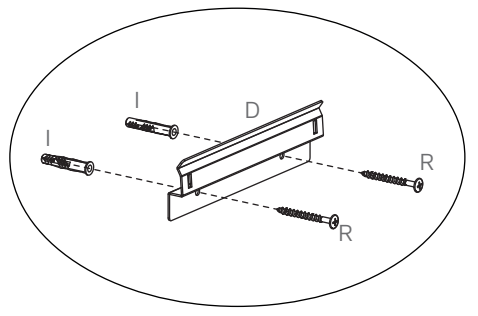
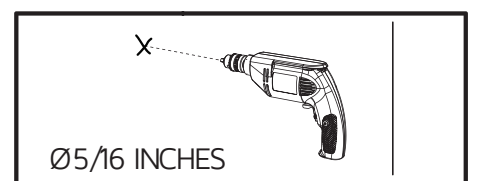
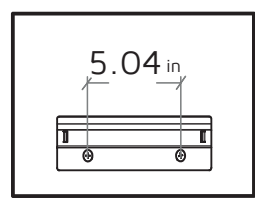
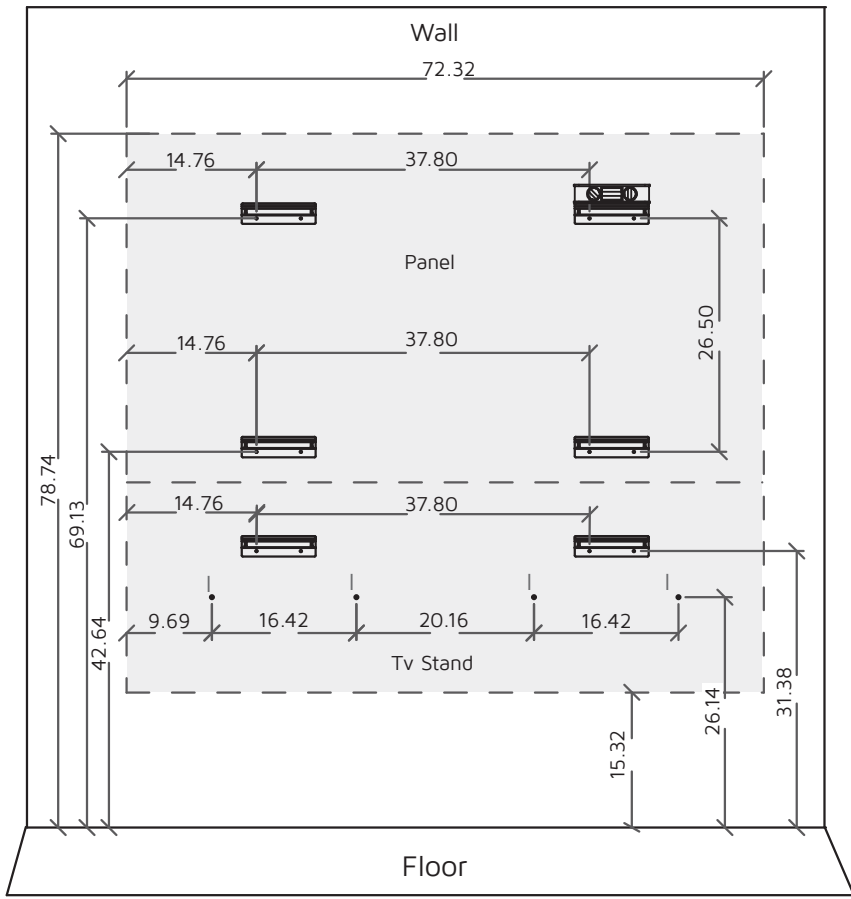

07

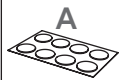
### Measurement to drill the wall.



STICKER <b>A</b> 	WIRE CHANNEL <b>D</b> 	COD. 2511 <b>F</b> 	COD. 7519 <b>Q</b> 	COD. 4505 <b>S</b> 
---	--	---	---	---

08

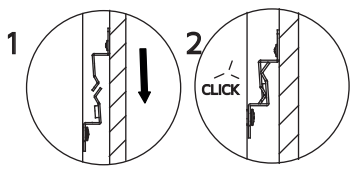
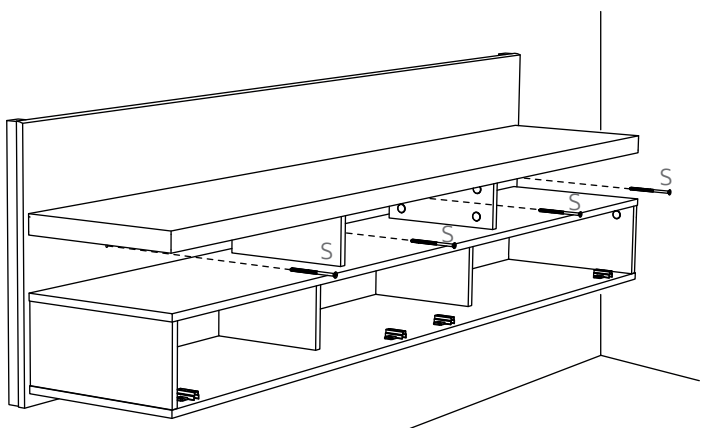
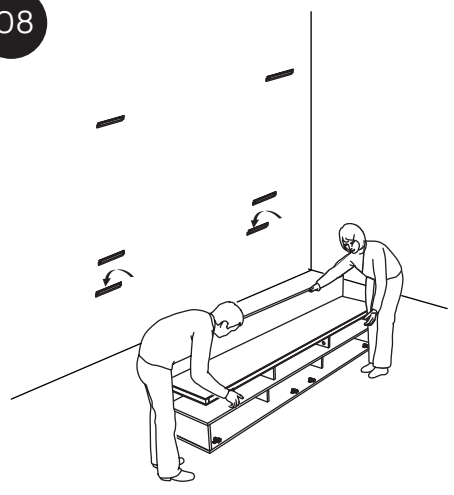

**ATTENTION**  
Pass the cables through the wire channel before screwing (S)

09

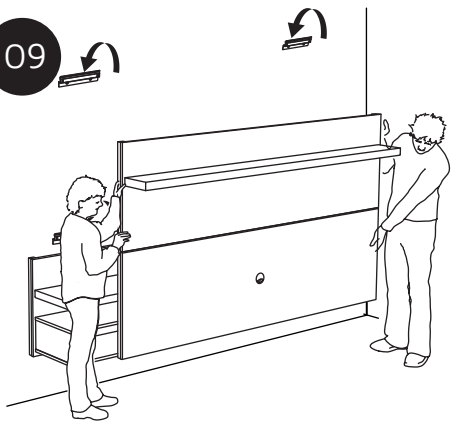

**ATTENTION**  
Pass the cables through the back before Panel.

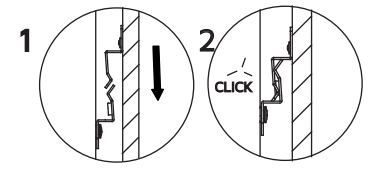

10

