

CONTACT US

If you have any questions or comments, please feel free to reach out to our customer care at any time and we will be able to assist you further. Thank you for choosing us.

ELECTRONIC TOILET SEAT

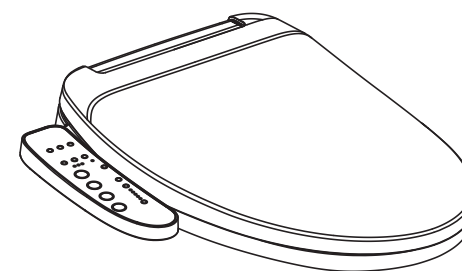

TABLE OF CONTENTS

● SAFETY PRECAUTIONS	01
● PARTS DIAGRAM	05
PRODUCT OVERVIEW	05
CONTROL PANEL	06
● PRODUCT INSTALLATION	07
TOOLS NEEDED	07
PARTS INCLUDED	07
BEFORE INSTALLATION	08
INSTALLATION STEPS	09
● PRODUCT OPERATION	11
BASIC FUNCTIONS	11
DRYER	13
UV STERILIZATION	13
OTHER FUNCTIONS	14
RESTORING FACTORY SETTINGS	14
MAINTENANCE	15
TROUBLESHOOTING	17
● PRODUCT INFORMATION	19
SPECIFICATIONS	19
MODEL COMPARISON CHART	20

IMPORTANT SAFEGUARDS

When using electrical products, especially when children are present, basic safety precautions should always be followed, including the following:

READ ALL INSTRUCTIONS BEFORE USING

DANGER – To reduce the risk of electrocution:

1. Do not use while bathing.
2. Do not place or store product where it can fall or be pulled into a tub or sink.
3. Do not place in or drop into water or other liquid.
4. Do not reach for a product that has fallen into water. Unplug immediately.

WARNING – To reduce the risk of burns, electrocution, fire, or injury to persons.

1. Close supervision is necessary when this product is used by, on, or near children or invalids.
2. Use this product only for its intended use as described in this manual. Do not use attachments not recommended by the manufacturer.
3. Never operate this product if it has a damaged cord or plug, if it is not working properly, if it has been dropped or damaged, or dropped into water. Return the product to a service center for examination and repair.
4. Keep the cord away from heated surfaces.
5. Never block the air openings of the product or place it on a soft surface, such as a bed or couch, where the air openings may be blocked. Keep the air openings free of lint, hair, and the like.
6. Never use while sleeping or drowsy.
7. Never drop or insert any object into any opening or hose.
8. Do not use outdoors or operate where aerosol (spray) products are being used or where oxygen is being administered.
9. Connect this product to a properly grounded outlet only. See Grounding Instructions.
10. Do not use while bathing.
11. Risk of Electric Shock. Connect Only to a Grounding Type Receptacle Protected by a Ground-Fault Circuit-Interrupter (GFCI).
12. CAUTION - Risk of electric shock, do not remove cover (or back). Refer servicing to qualified service personnel.

SAVE THESE INSTRUCTIONS

GROUNDING INSTRUCTIONS

This product should be grounded. In the event of an electrical short circuit, grounding reduces the risk of electric shock by providing an escape wire for the electric current. This product is equipped with a cord having a grounding wire with a grounding plug. The plug must be plugged into an outlet that is properly installed and grounded.

DANGER – Improper use of the grounding plug can result in a risk of electric shock.

If repair or replacement of the cord or plug is necessary, do not connect the grounding wire to either flat blade terminal. The wire with insulation having an outer surface that is green with or without yellow stripes is the grounding wire.

Check with a qualified electrician or serviceman if the grounding instructions are not completely understood, or if in doubt as to whether the product is properly grounded.

SAFETY PRECAUTIONS

IMPORTANT! READ ALL INSTRUCTIONS BEFORE USING

Please carefully read this manual before use and keep for future reference.

The following icons are used in this manual to indicate varying severities of hazards. Please abide by these precautions, otherwise serious consequences may occur.

NOTATION

WARNING Please pay close attention to avoid serious harm or accidents.

ATTENTION If not attentive, body or property damage may result.



. . . . Caution! Comply with guidelines.



. . . . Prohibited action!



. . . . Do not dismantle!



. . . . Keep away from direct contact with water or any liquid.



. . . . Do not touch this area!



. . . . Do not touch this area with wet hands!



. . . . Keep away from fire!



. . . . Operate as instructed.



. . . . Please unplug!



. . . . Please confirm it is grounded!

SAFETY PRECAUTIONS

⚠ WARNING

Make sure the power supply is grounded.
 ▶ Otherwise, electric shock may occur.
 ▶ Please consult qualified electrician or serviceman if the power supply is not grounded.



Do not place lit cigarettes or other ignited items on the product.
 ▶ Otherwise, fire may occur.



Do not touch or plug in the cord with wet hands.
 ▶ Otherwise, electric shock may occur.



Do not place lit cigarettes or other ignited items on the product.
 ▶ Otherwise, the device may be damaged or malfunction.



Do not connect power cord if the cord is damaged or broken.
 ▶ Otherwise, electric shock or fire may occur.

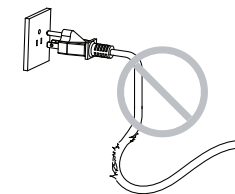

The product must be connected to standard voltage power source (AC120V±10%, Max Current 16A).
 ▶ Otherwise, electric shock or fire may occur.

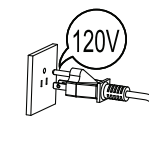

When the seat or lid is broken, please unplug the power and shut down the water supply.
 ▶ Otherwise, electric shock or fire may occur.



Unplug and clean the dust on the power cord with a dry cloth regularly.
 ▶ Otherwise, fire may occur due to bad insulation.



Individuals who are handicapped (physically, mentally, or emotionally) must be accompanied during use.
 ▶ Otherwise, long-term use may cause low-grade burns.



Do not forcefully pull, break, bend, strip, twist, or over squeeze the power cord and cable.
 ▶ Otherwise, electric shock or fire may occur.



The cord must be replaced by authorized personnel
 ▶ Otherwise, electric shock or fire may occur.



Please avoid installing the product while bathroom is wet. Do not splash water on the product.
 ▶ Otherwise, electric shock, fire, damage may occur.



Children should not play with this product.
 ▶ Otherwise, injury may occur.



Do not dismantle this product to repair or remodel. Only Authorized personnel such as a qualified electrician should service the product.
 ▶ Otherwise, malfunctions may cause electric shock, fire, or injury.



Do not urinate on the product.
 ▶ Otherwise, electric shock may occur.



Do not use polluted water supply.
 ▶ Otherwise, the water may damage the device or harm the user.



SAFETY PRECAUTIONS

⚠ ATTENTION

If using any chemical toilet bowl cleaner, be sure to wipe up any spills that splash onto the plastic areas of the product. Do not use any acidic chemical detergent. Only neutral detergents are permitted.

► Otherwise, the plastic may break and cause body damage, electric shock, or fire.



Do not stand, sit, or lean forcefully on the lid of the bidet toilet seat. Do not open or close the lid/seat ring forcefully to avoid damage.



Do not block the dryer door with hands or other objects. Do not cover the door during use.

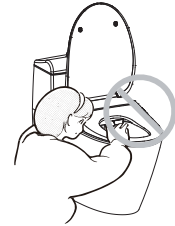

Please do not let water or detergent wet the bidet toilet seat or power plug.

► Otherwise, there may be a risk of electric shock or fire.



SAFETY PRECAUTIONS

⚠ WARNING

Do not use warm or heated temperature settings for extended periods of time.



Do not expose to direct sunlight or heating device.



Please make sure the user is fully seated (see image below). Otherwise, the cleaning or drying function will stop.



Do not use a timer power source or external switch to turn the device on/off. The thermal cutoff device may cause danger.



Please turn off the water supply before replacing the filter. Firmly attach the filter before opening the water supply.



► Otherwise, leakage may occur.

Do not urinate on the nozzle.

► Otherwise, the nozzle may become obstructed.



Please unplug and close water sources to the device when away for extended periods of time.



► Otherwise, leakage or fire may occur.

Please use provided accessories to install the device. Do not use old parts.



► Otherwise, leakage may occur.

In very low temperatures, the water within the device may freeze after long periods of disuse. To avoid damage, please warm the unit to melt the ice.



During power failure, unplug the device and close the water supply valve to prevent leaking.



PARTS DIAGRAM

PRODUCT OVERVIEW

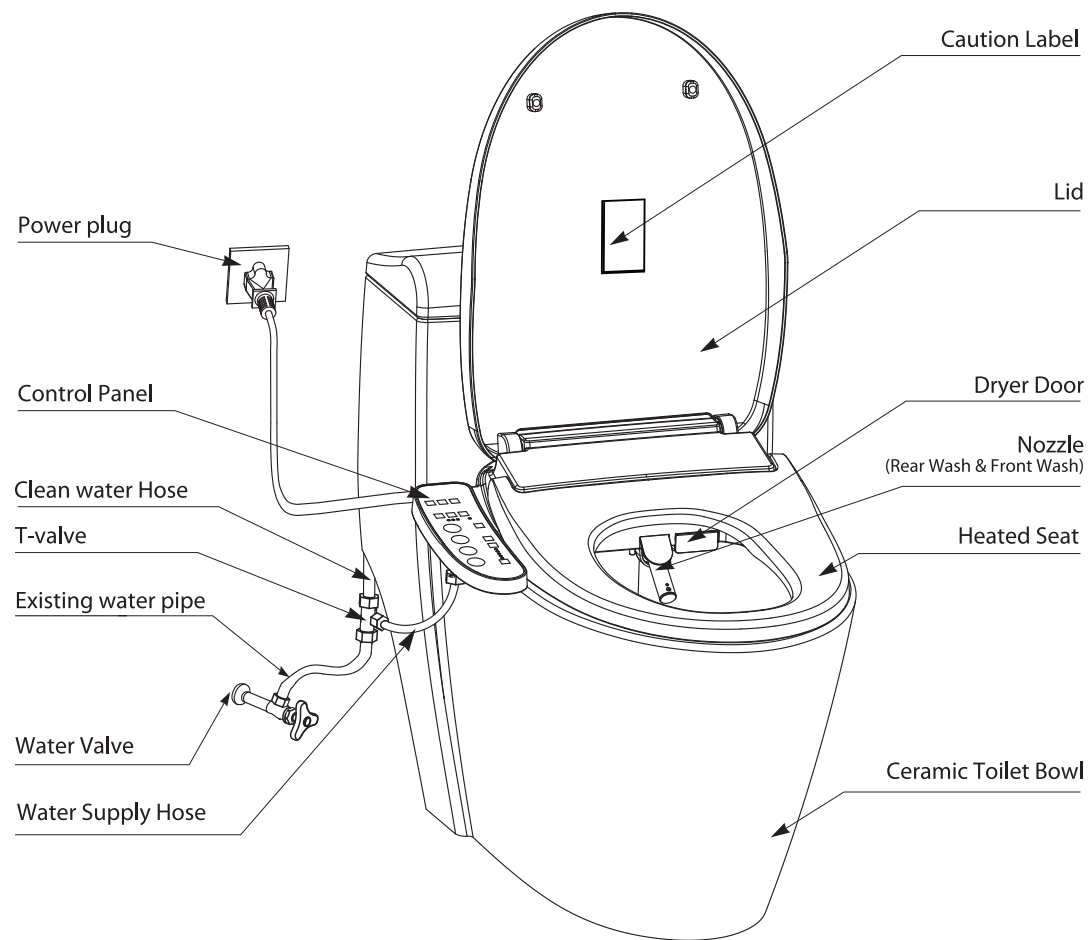

VIEW FROM THE RIGHT

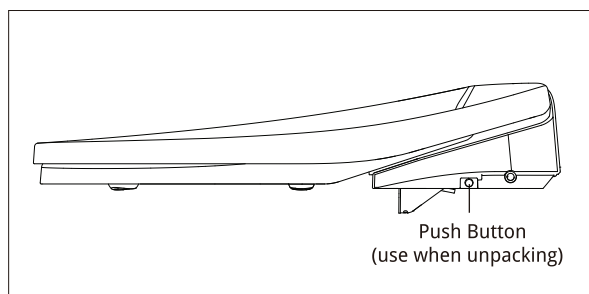

VIEW FROM THE LEFT

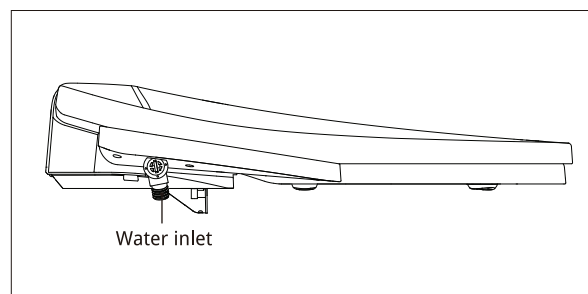

PARTS DIAGRAM

CONTROL PANEL

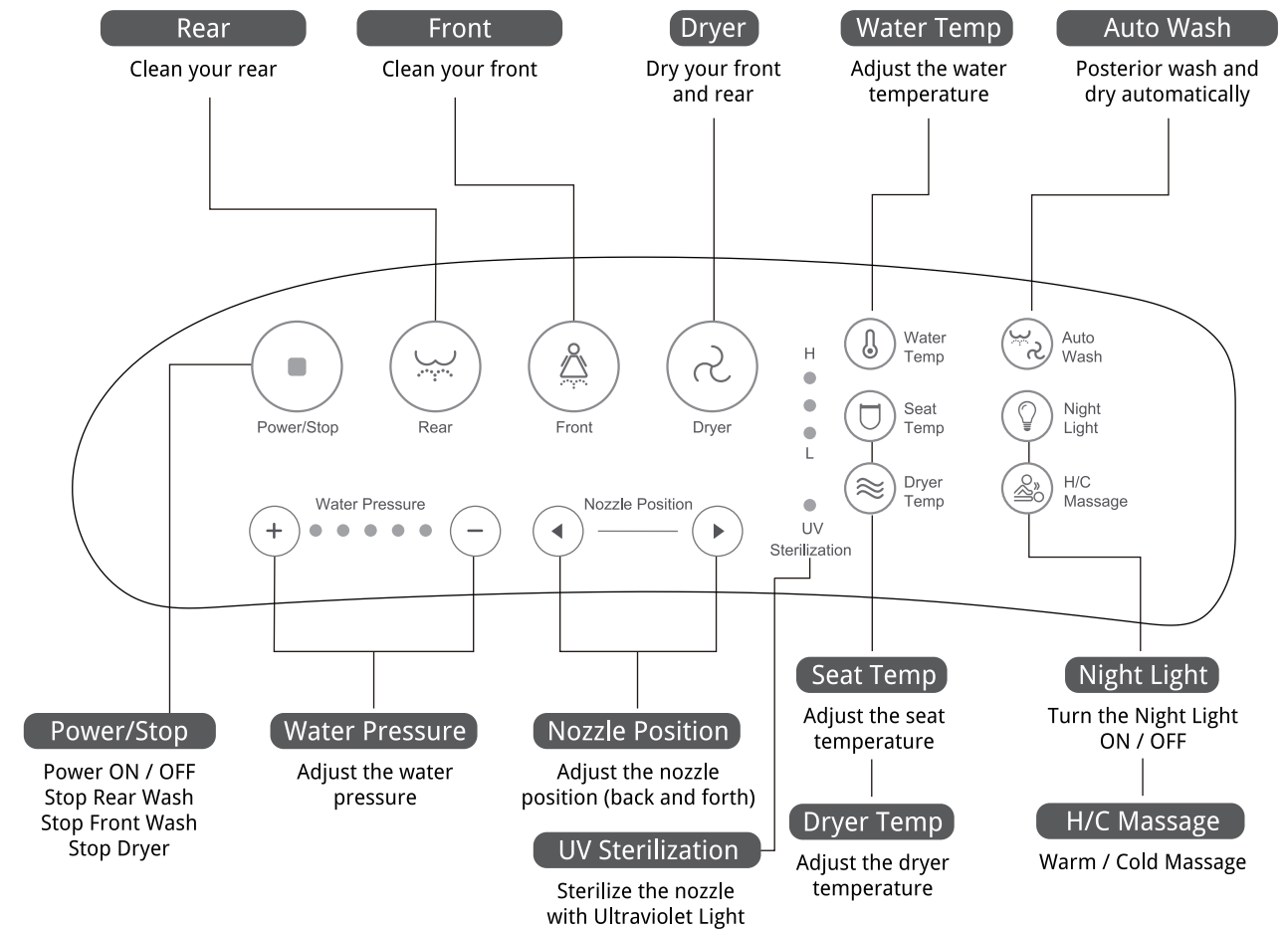

PRODUCT INSTALLATION

TOOLS NEEDED

Adjustable Wrench (1.02in+ width) **OR** Open End Wrench (0.91-1.02in)



OR

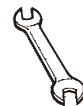

Phillips ⊕ Screw Driver

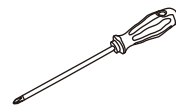

PARTS INCLUDED

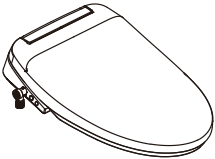
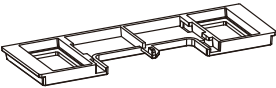
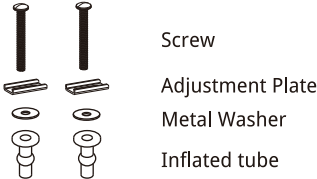
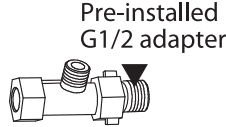
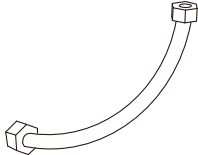
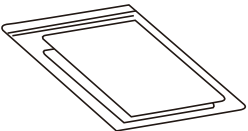
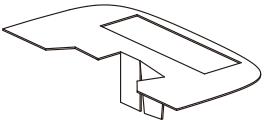
<p>Smart Bidet (1 set)</p> 	<p>Catch Plate (1 pc)</p> 	<p>Screw components (1 sets)</p> 
<p>T-valve (1 pc)</p> <p>Pre-installed G1/2 adapter</p>  <p>(15/16", G1/2, 15/16")</p>	<p>Hose (1 pc)</p> 	<p>Owner's Manual (1 pc)</p> 
<p>Fixed Card (1 pc)</p> 		

- ※After opening the package, please confirm that you have received all parts listed above.
- ※If you are missing any parts, please contact us.
- ※If your water valve is 15/16", you could directly connect the T-valve;
- ※If your water valve is G1/2, please screw on the adapter, then connect it.

PRODUCT INSTALLATION

BEFORE INSTALLATION

IMPORTANT! Before installing the product, please make sure that you meet all the requirements listed below.

Power Requirements

- ▶ The power rating should be within the required range (AC 120V ± 10%, Max current 16A above)
- ▶ The power outlet should be close enough to reach the power cord (47.24in) but far from where water can hit it.
- ▶ This product must be grounded.
- The wiring should be installed by a professionally licensed electrician.
- Please do not plug in the product before installation is complete to prevent malfunction.

Water Requirements

- ▶ The minimum dynamic water pressure required is 11.6psi.
- ▶ The maximum static water pressure required is 116psi.
- ▶ Water pressure below the min and max range above will affect the performance of the product.

Sizing Requirements

- ▶ Please measure your toilet to make sure that there is enough space for the bidet (20.39 in long).

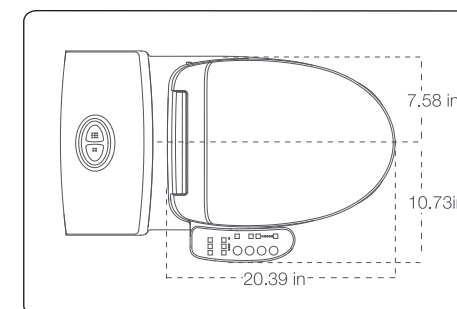

- ▶ The distance between the 2 mounting holes must be within 4.72-6.89 in.
- ▶ The distance from the filter to the bidet inlet should be 21.65 in or less.
- ▶ The distance between the mounting holes and the edge of the toilet bowl must be within 17.99-19.72 in.

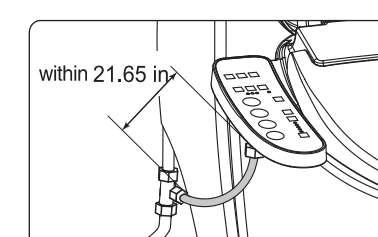
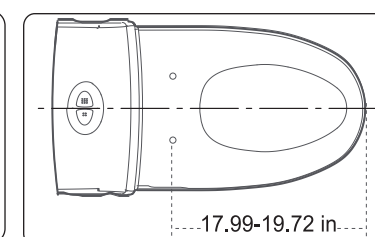
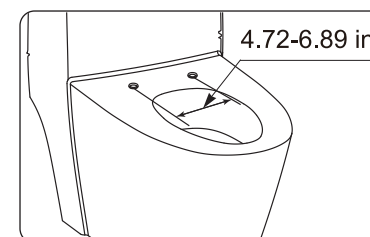

※The product has no Ground Fault Circuit Interrupter, It should be installed in the line with Ground Fault Circuit Interrupter, Otherwise, the accidental failure of this product may result in the loss of life or property.

PRODUCT INSTALLATION

INSTALLATION STEPS

1 Install the electronic bidet seat

1. Remove the existing toilet seat.
 - (a) Remove the toilet seat mounting bolts.
 - (b) Remove the existing toilet seat from the toilet.

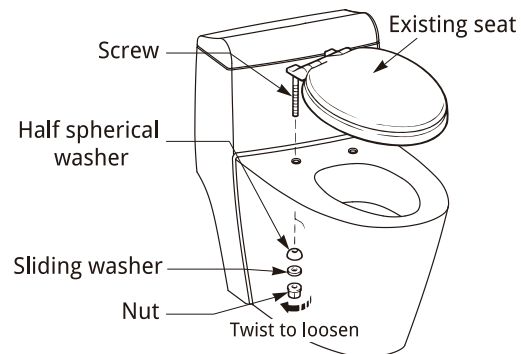

2. Insert the inflated rubber tube set into the mounting holes on the toilet bowl.

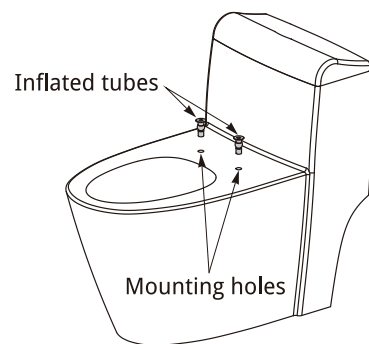

3. Place the Fixed Card on the toilet bowl where the mounting holes are. Make sure that the wash / dry gates are close to the rim and pointed down

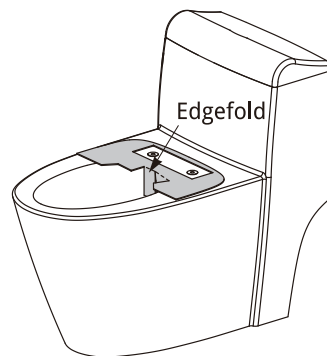

4. Install the fixing plate
 - (a.) Place metal washers on the inflated tubes.
 - (b.) Place the fixing plate in the rectangle space of the fixed card.
 - (c.) Place the adjustment sheet on the fixing plate.
 - (d.) Insert and tighten the screws.

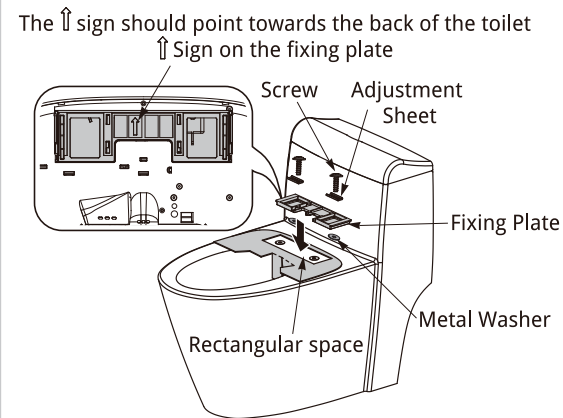

5. Install the electronic toilet seat
 - (a.) Remove Fixed Card.
 - (b.) Press the push button and slide the seat into the fixing plate.
 - (c.) Adjust the seat for best fit. Loosen the screws for adjustment when needed.

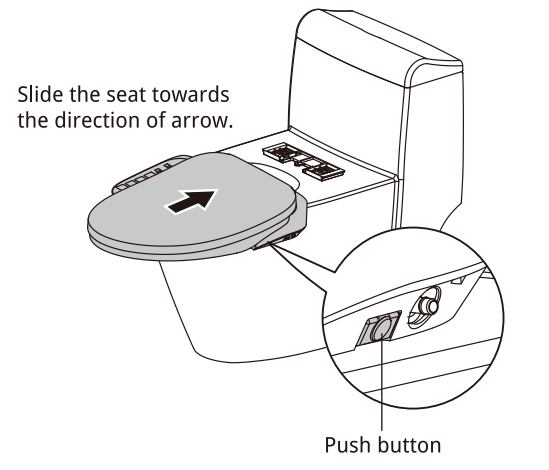

PRODUCT INSTALLATION

INSTALLATION STEPS (CONT.)

2 Install the filter and hoses

1. Connect T-valve to tank.

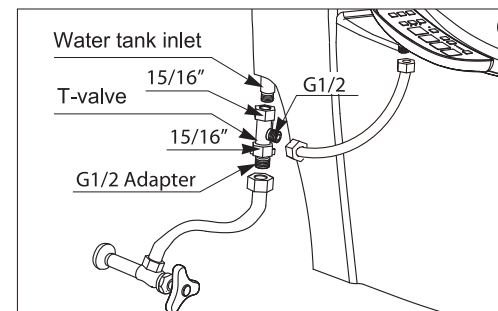

2. Existing water pipe connect T-valve.

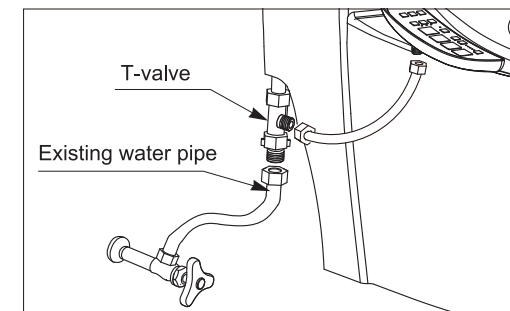

3. Connect the hose to T-valve.

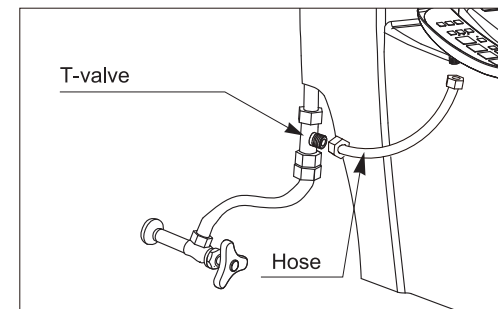

4. Connect the hose to bidet. (Available in 15/16" and G1/2 connectors.)

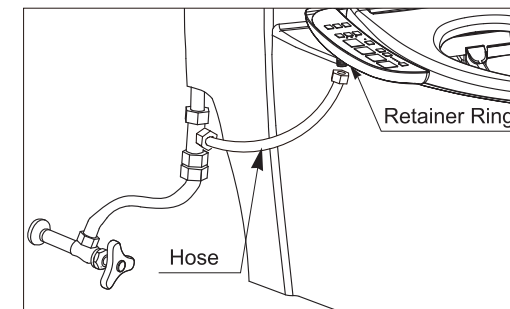

3 Turn on the water

1. Turn the water supply on. The angle valve should be fully open.
2. Check for leaks. Make sure there is no leakage. If there is leaking from any connection, re-install the part.

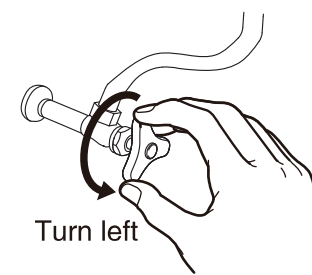

4 Link the power

1. Insert the bidet plug into the outlet (120V).
2. Confirm the power connection.

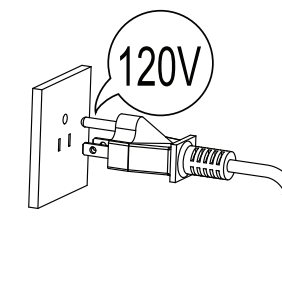

PRODUCT OPERATION

BASIC FUNCTIONS

- ▶ Functions will only work when user is seated on the bidet seat.
- ▶ Dryer will automatically stop after using for 4 minutes.

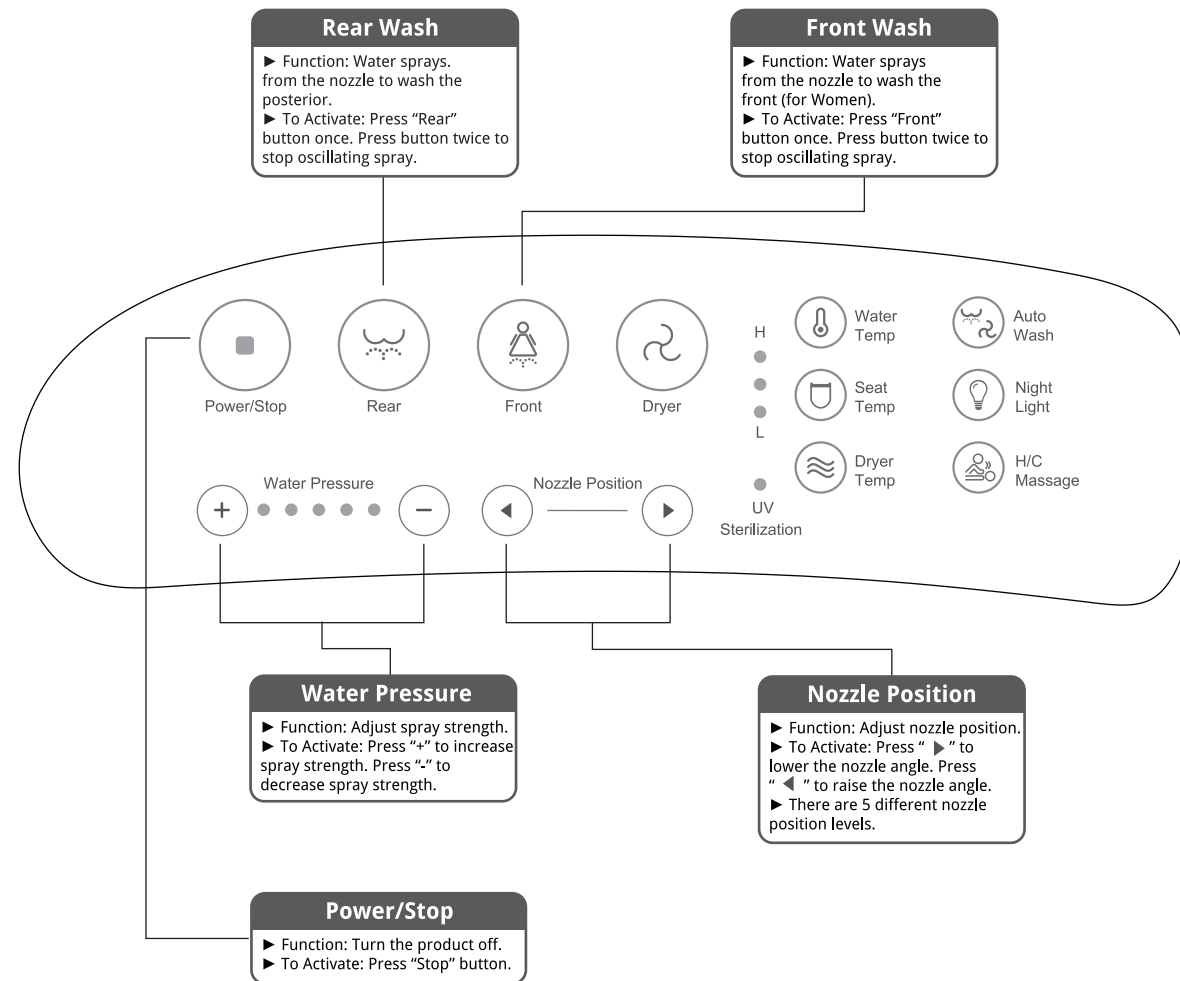

PRODUCT OPERATION

BASIC FUNCTIONS (cont.)

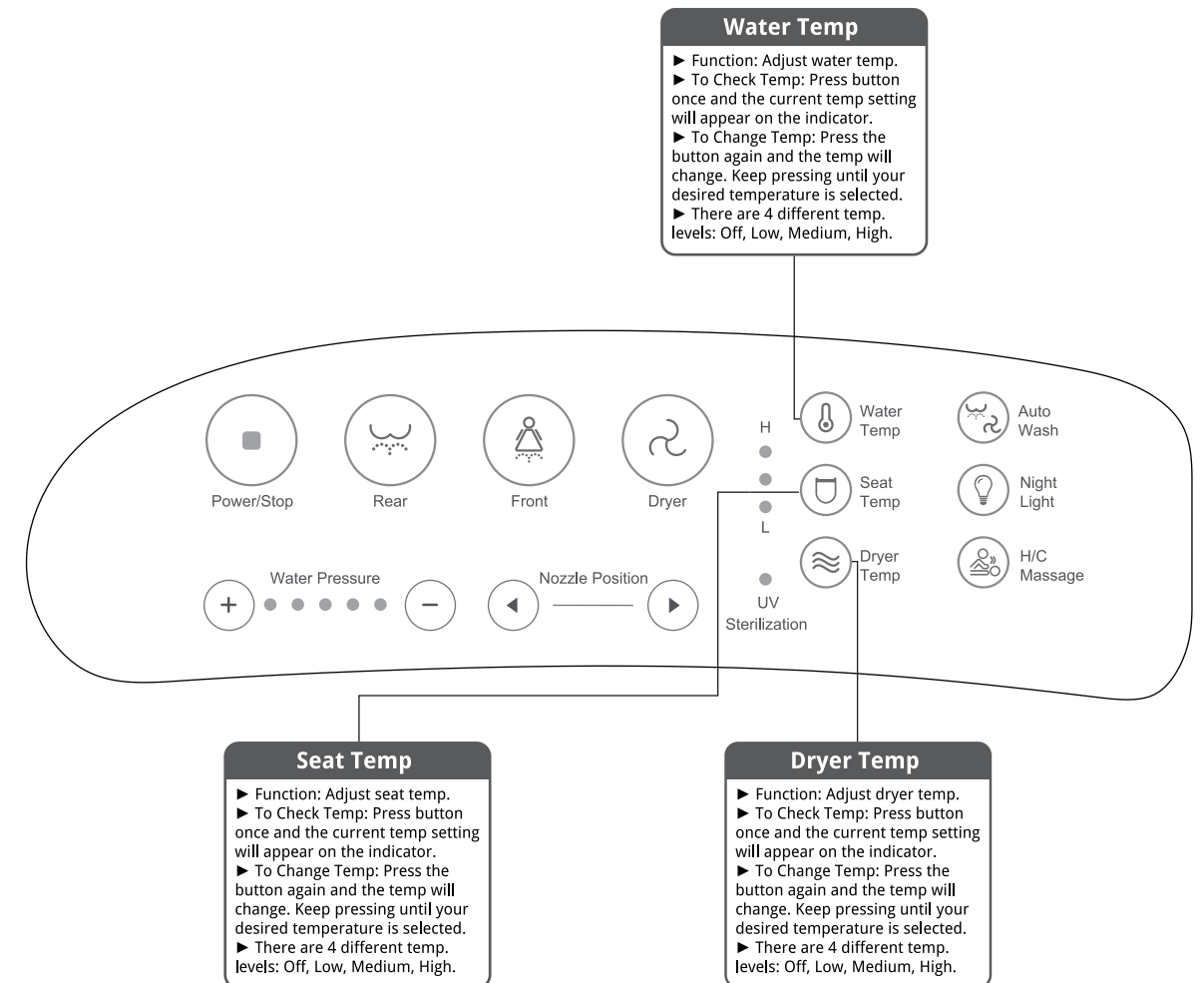

PRODUCT OPERATION

DRYER

► Dryer will automatically stop after using for 4 minutes.

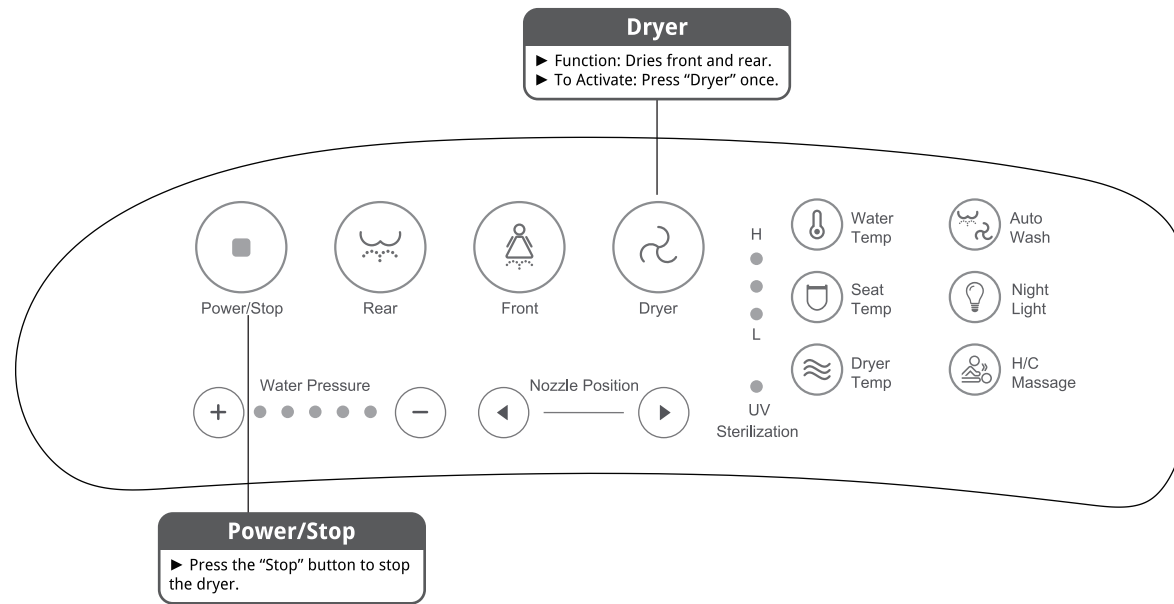

UV STERILIZATION

► 10s after user unseats, UV sterilization will initiate automatically to work for 3 minutes. The UV sterilization indicator will turn on when UV sterilization is in progress and will turn off when complete.

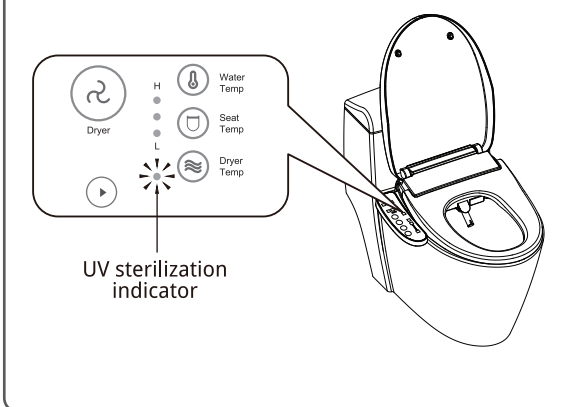

PRODUCT OPERATION

OTHER FUNCTIONS

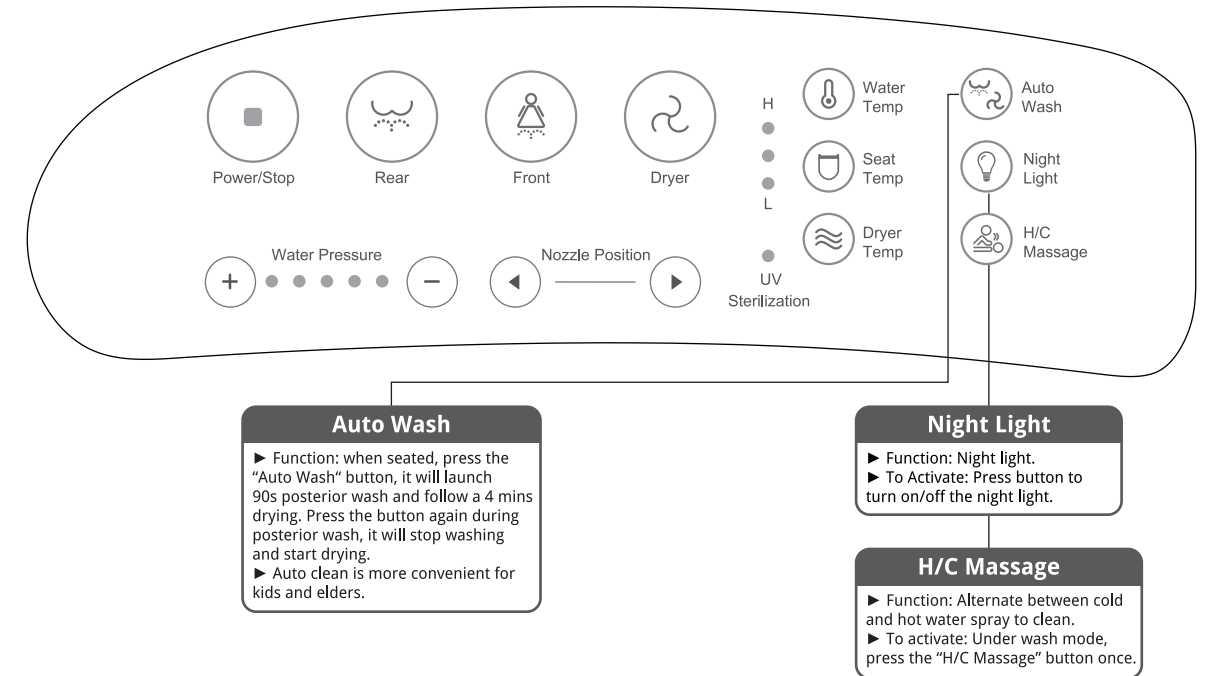

RESTORING FACTORY SETTINGS

► To restore the product to the original factory settings, pull the plug from the wall, wait 1 minute, then reconnect the plug. The Water Temp., Seat Temp., Dryer Temp., Spray Strength, and Nozzle Position will restore to the original Middle level settings.

PRODUCT OPERATION

MAINTENANCE

- ▶ Before maintenance, please unplug the power source and shut off the water supply.
- ▶ Regular maintenance is required to ensure that the product operates at optimum efficiency.

Maintenance of Lid, Seat, and Plastic Parts

- ▶ Wipe the lid, seat, and plastic parts with a wet soft cloth (water).
- ▶ Please wipe with water frequently or the product will become hard to clean later if the dirt and debris is not removed on time. Wiping with water can also help prevent static electricity from generating around the product, which can cause the product to accumulate dust and become dirty.
- ▶ For a deeper clean, the bidet can be removed from the toilet to access the surface beneath. To remove the bidet, press the catch plate button located on the right side of the bidet, then lift the bidet slightly to extract. (do not remove the bidet forcefully).



Maintenance of Steel Mesh Filter

- ▶ For your health, as well as optimal performance of the bidet, please clean or replace the filter regularly.
- ▶ If you notice that the water pressure is becoming weaker, please wash or replace the filter.
- ▶ Please make sure to turn off the water supply completely before removing the filter. Attach the new filter securely to avoid leakage.
- ▶ Turn the coin counterclockwise to open the filter and use a brush to clean.



Recommended: Every 1-2 months

PRODUCT OPERATION

MAINTENANCE (cont.)

⚠ ATTENTION

- Do not spray water or detergent on the bidet, remote control, or power cord.
- ▶ Otherwise, electric shock or fire may occur.

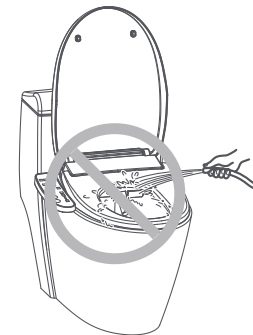

⚠ WARNING

- While cleaning the plastic parts, do not use strong, acidic chemical cleaners (concentrated sulfuric acid, nitric acid, glacial acetic acid, carbon tetrachloride, chloroform, acetone, butyl ketone, benzene, toluene, phenol, cresol, methyl ether, methyl formamide, soybean oil, vinegar, 40% nitric acid, hydrochloric acid, 95% alcohol liquor, gasoline, kerosene, brake oil, etc.). Please only use neutral cleaners.
- ▶ Otherwise, the plastic may break, and cause body damage, electric shock, or fire.



Maintenance of the Nozzle

- ▶ Long Press "Water Temp" button without occupying the seat, the nozzle will extend and can be cleaned with a soft brush.
- ▶ Do not try to pull the nozzle out with force, or the nozzle may break.
- ▶ When the nozzle is clogged, it is recommended to replace it with a new one.

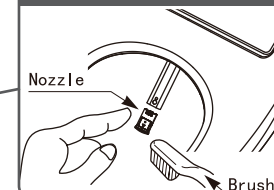

PRODUCT OPERATION

TROUBLESHOOTING

► If you experience any of the problems below, please follow the suggested solutions. If you continue to experience issues after trying the solutions, please consult with a qualified electrician or serviceman.

Power button

Problem	Possible Causes	Possible Solutions
Toilet is not working	Blackout or loose socket	Check that power cord is plugged in
	Power off (Power indication light not on)	Press power button until indication light turns on
	Electric leakage	Unplug power cord, re-connect, then power on. If it is still not working, please unplug again and contact us

Wash functions

Problem	Possible Causes	Possible Solutions
Water does not spray	No water in the supply	Wait for the water to restore to its normal levels
	Water supply is turned off	Turn water supply valve to turn on water
	Filter is stuck	Clean or replace filter
	Water hose is twisted	Stretch hose until it becomes untwisted
Water pressure is weak	Water level is set to LOW	Turn up water level to higher setting
	Filter is stuck	Clean or replace filter
Spray is off-center	Operational failure	Unplug device and re-plug in after 1 min
Water is not warm	Water temp. is set to LOW	Turn up water temp. level to higher setting
Water is leaking	Parts are loose or damaged	Contact us
Wash function does not activate	Check if the seat is lifted or sitting on something	Fix seat so it is flush on the bowl and remove any objects underneath
	Body sensor is broken	Contact us

PRODUCT OPERATION

TROUBLESHOOTING (cont.)

Dryer

Problem	Possible Causes	Possible Solutions
Dryer is not warm	Dryer temp. is set to OFF	Turn up dryer temp. to higher setting
	Dryer is broken	Contact us
Dryer stops during use	Dryer will stop every 4 mins	Enable dryer again

Heated Seat

Problem	Possible Causes	Possible Solutions
Seat temp. not warm	Seat temp. is set to OFF	Turn up seat temp. to higher setting

Other

Problem	Possible Causes	Possible Solutions
Lid or seat closes fast	Damping is broken	Contact us
Functions work in turns nonstop	QA testing model activated	Unplug device and re-plug in after 1 min

PRODUCT INFORMATION

SPECIFICATIONS

Model Number	B0403	
Rated Voltage	AC 120V, 60Hz	
Rated Power	1050W	
Environmental Temp	39.2°F-104°F	
Water Inlet Environment	39.2°F-95°F	
The range of water inlet pressure	Minimum necessary water pressure	11.6psi, ensuring a flow of water at least 3.65 GPM
	Maximum water pressure	116psi (in a static condition)
Flushing	Way for heating	Instant heating
	Temp pf warm water	Off/about 93.2°F-102.2°F
The length of power line	About 47.24in	
The size of product	20.43in x 16.06inx 4.84in	

PRODUCT INFORMATION

MODEL COMPARISON CHART

Part no.	B0403
Unlimited wash	●
Rear Wash	●
Front Wash	●
Aerated Wash	●
Automatic Wash	●
Oscillating Wash	●
H/C Massage	●
Water Pressure Adjustable	●
Water Temp Adjustable	●
Nozzle Position Adjustment	●
Detachable Nozzle	●
Self-cleaning Nozzle	●
Nozzle Cleaning Mode	●
Seat Heating	●
Air Dryer	●
Soft Close	●
Seat Temp Adjustable	●
Air Temp Adjustable	●
Night Light	●
Instant Heating	●
Seat Sensor	●
Memory Mode	●
Auto Start	●
Air isolation	●
UV Sterilization	●
SUS filter	●
Eight Safety Protections	●
Antibacterial Seat	●

Notice: ● represents that the product have this function.