











INSTRUCTIONS

IMPORTANT: In order to make the whole product adjust to the best, please install all the screws on the product before fully tightening, and note to put the washer to the screw before putting the screw into the screw hole.

Please follow the instructions below to ensure that the furniture is stable and firm.

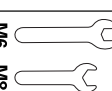
											
A	B	C	D	E	K	F	G	H	I	J	L
1pc	1pc	1pc	1pc	3PCs	4PCs	4PCs	4PCs	1pc	1pc	2PCs	2PCs
		left	right	cushion	M8	35mm M6	75mm M6		M6 M8	95mm	60mm M6

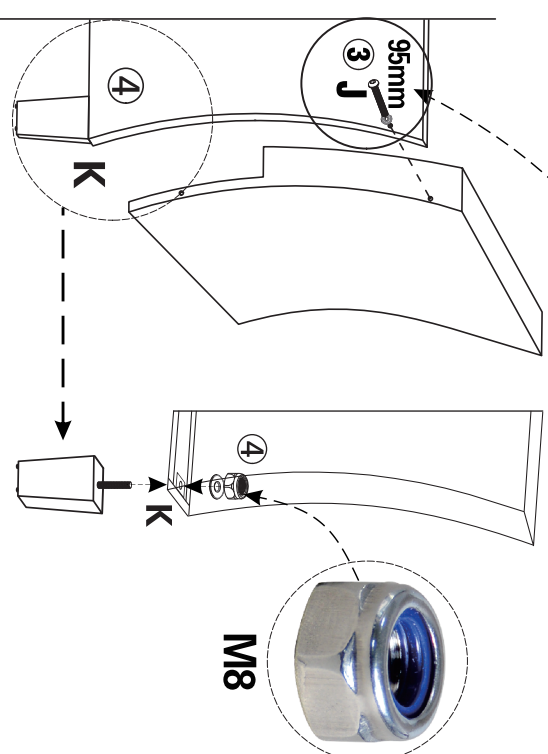
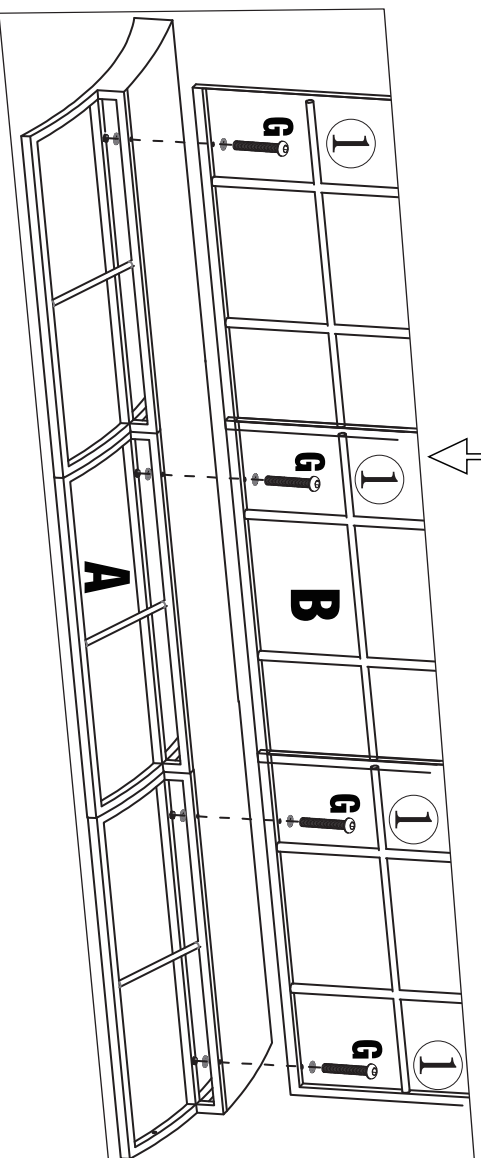
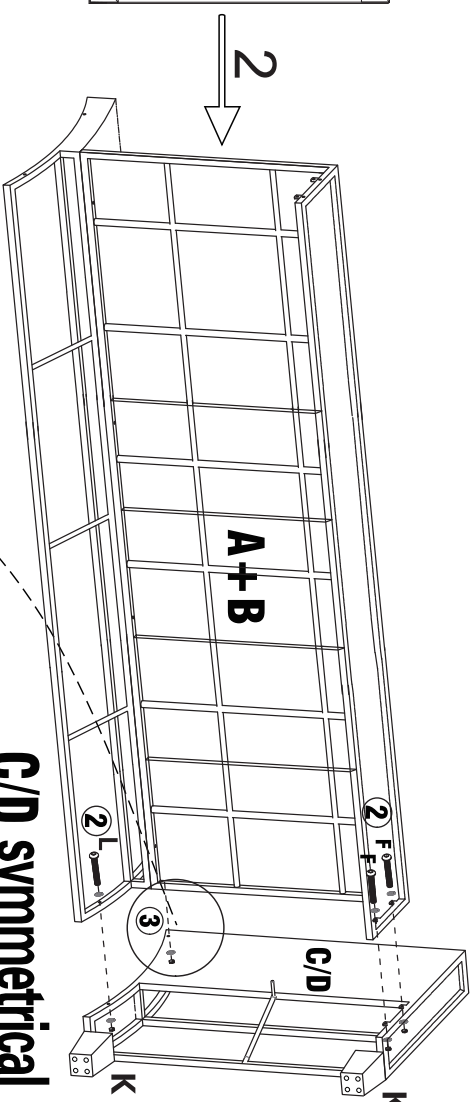
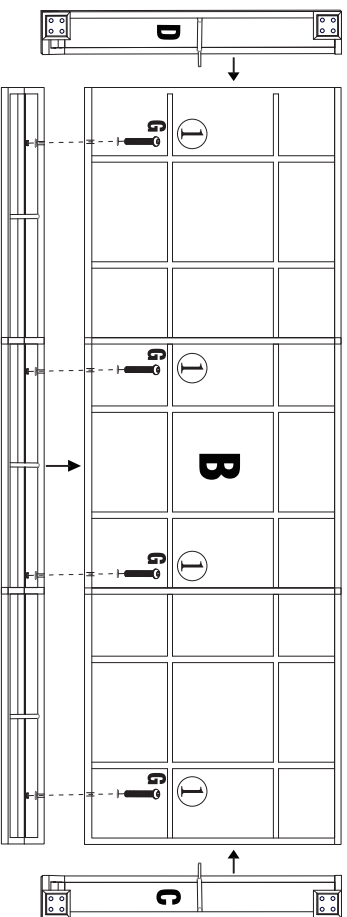
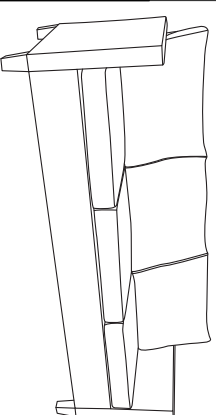

C/D symmetrical

INSTRUCTIONS

Single sofa

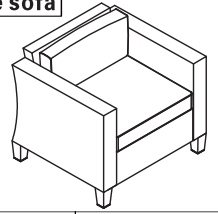

IMPORTANT: In order to make the whole product adjust to the best, please install all the screws on the product before fully tighten, and note to put the washer to the screw before putting the screw into the screw hole.

Please follow the instructions below to ensure that the furniture is stable and firm.

A 1pc	B 1pc	C 1pc	D 1pc	E 1pc	K 4PCs	F 4PCs	G 2PCs	H 1pc	I 1pc	J 2PCs	L 2PCs

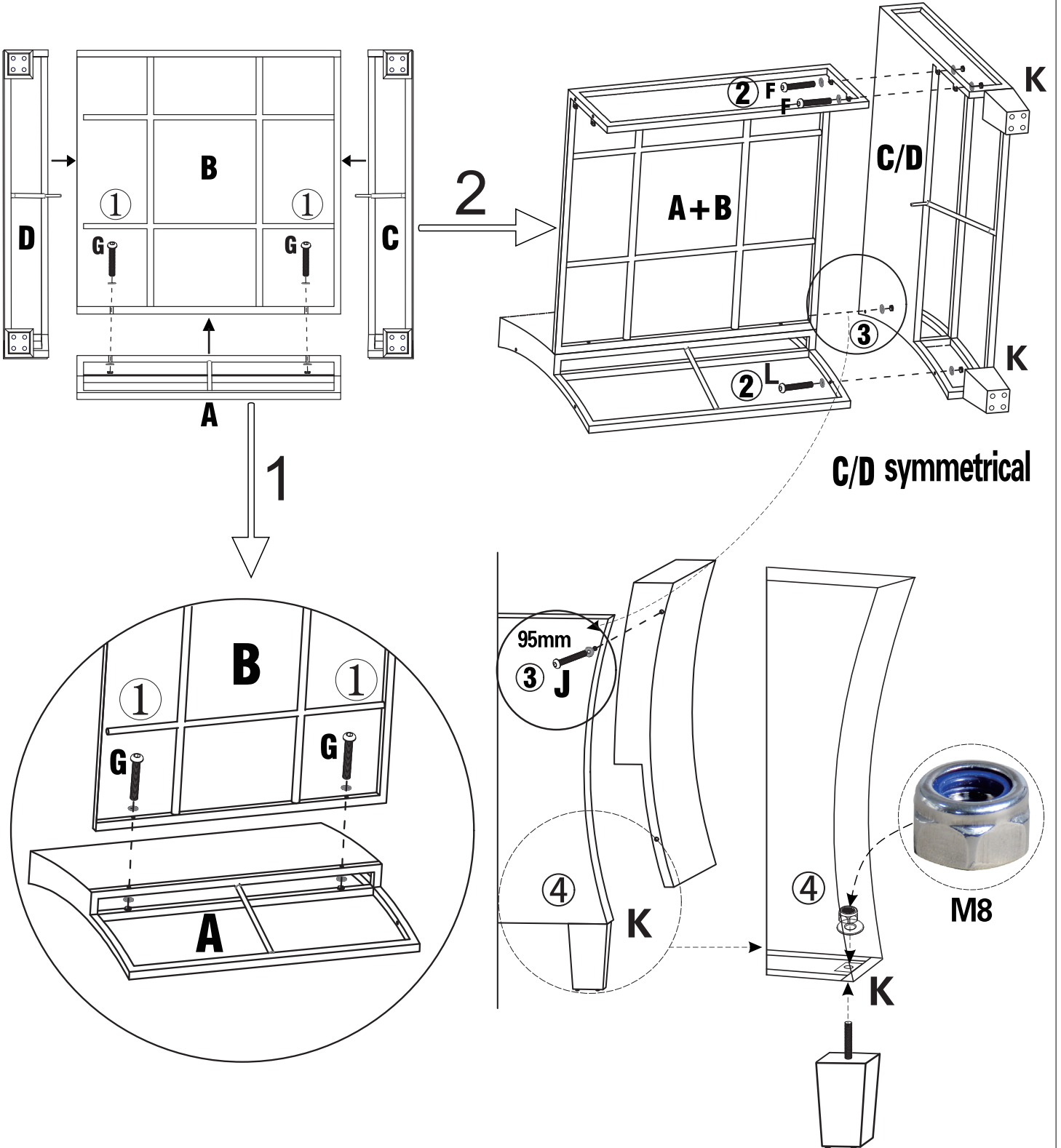

INSTRUCTIONS

IMPORTANT: In order to make the whole product adjust to the best, please install all the screws on the product before fully tighten, and note to put the washer to the screw before putting the screw into the screw hole.

Please follow the instructions below to ensure that the furniture is stable and firm.

Ottoman

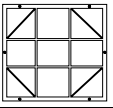
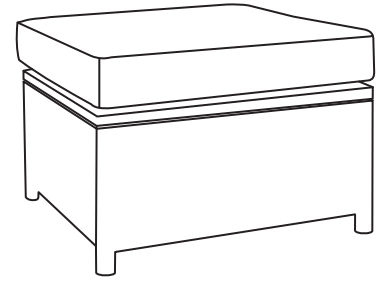

A 1pc

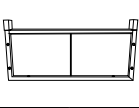

B 2PCs

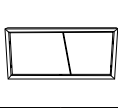

C 2PCs

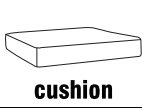

cushion



35mm



F 1pc

