



Location:

S-3601-TRM, S3601TRMTC  
Shower Trim  
Specification Submittal



**Feature Highlights**

- Duro Shower Trim
- Requires Temptrol® Pressure Balancing Shower Valve
- Integral volume control
- Metal lever handle
- 1 mode showerhead
- 2.5 gpm (9.5 L/min) flow restrictor
- Tub spout not included
- Components shall be metal and nonmetallic construction, plated in standard Polished Chrome finish
- Available with TA-10 flow control spindle and T-12A cap assembly for Temptrol valve bodies installed with Test Cap (order p/n S3601TRMTC)

**Model Numbers**

- S-3601-TRM**  
Shower Trim with integral volume control, Temptrol Pressure Balancing Shower Valve ordered separately
- S3601TRMTC**  
Shower Trim with integral volume control, TA-10 flow control spindle and T-12A cap assembly, must order Temptrol valve with Test Cap

**Compliance**



- ASME A112.18.1/CSA B125.1



**Warranty**

**Limited Lifetime** - to the original end purchaser in consumer/residential installations.  
**5 Years** - for industrial/commercial installations.  
 Refer to [www.symmons.com/warranty](http://www.symmons.com/warranty) for complete warranty information.  
 Go to [www.symmons.com/register](http://www.symmons.com/register) to register your Symmons product.

**Options/Modifications**

- 1.5**  1.5 gpm (5.7 L/min) flow restrictor
- 2.0** 2.0 gpm (7.6 L/min) flow restrictor
- EX** Exposed column/slide bar, hand shower bracket and hand shower wand (36EX)
- L1** Less showerhead
- LW**  Wide lever handle (chrome finish only)
- REB** Rebuild trim kit, includes TA-10 and TA-4
- SH1** Alternative 352SH Dia showerhead
- SH2** Alternative 352SH-3, 3 mode showerhead
- SH4** Alternative 361SH square showerhead
- VP** Vandal resistant escutcheon screws in place of standard screws
- BBZ** Brushed Bronze finish
- MB** Matte Black finish
- STN** Satin Nickel finish

**Note:** Append appropriate -suffix to model number.

## Dimensions

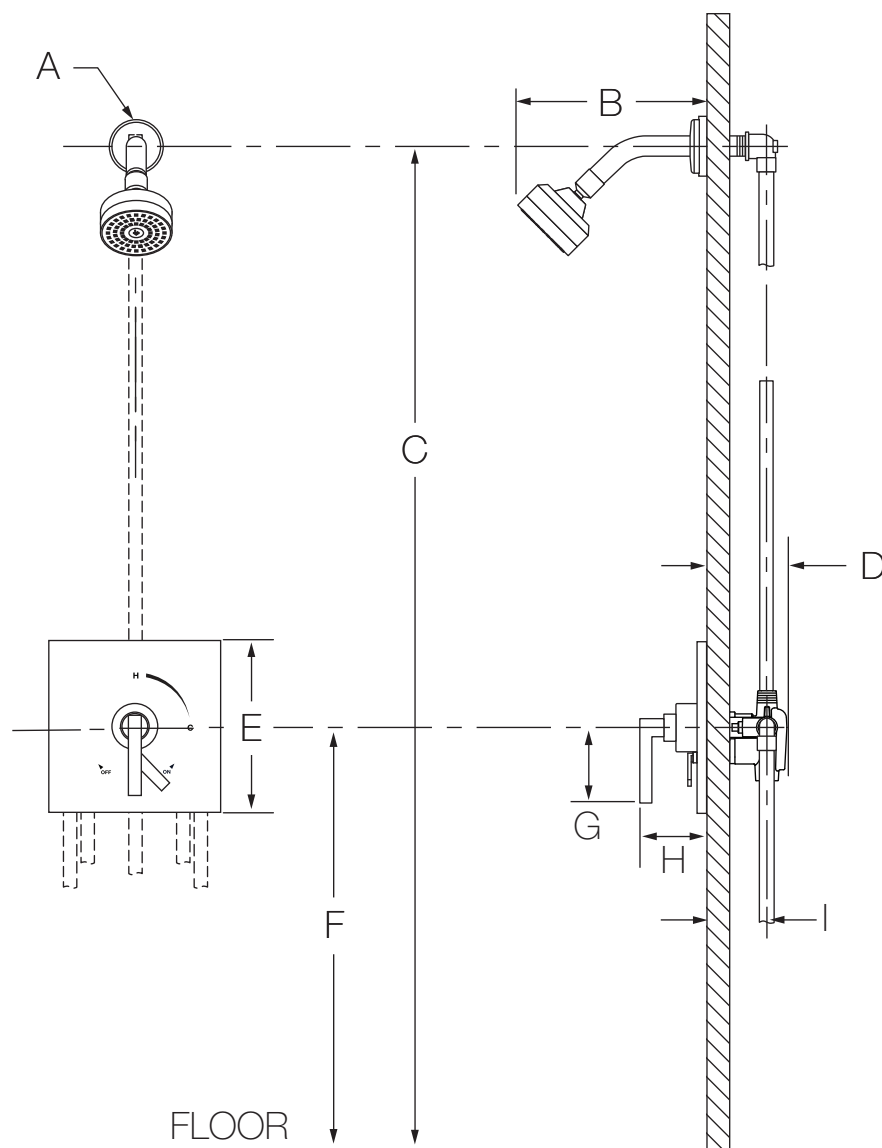

Measurements	
A	Ø 2-1/2", 64 mm
B	6", 152 mm
C	Ref. 77", 1956 mm
D	3-1/2", 89 mm
E	Sq. 7-1/2", 191 mm
F	Ref. 42", 1067 mm
G	3-1/8", 79 mm
H	3-1/2", 89 mm
I	Rough-in 2-3/8" ± 1/2", 60 mm ± 13 mm
J	6-3/4", 171 mm
K	6-3/4", 171 mm
L	5-5/8", 143 mm

**-SH1**

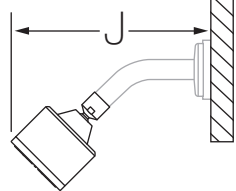

**-SH2**

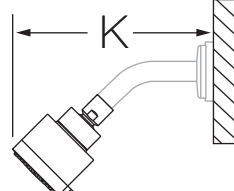

**-SH4**

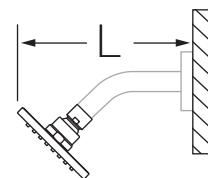
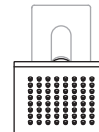

### Notes:

- 1) Valve body and piping not included and shown as reference only.
- 2) Plaster shield (p/n T-176) for dry wall, plaster or other type walls 1/2" or greater.
- 3) All dimensions measured from nominal rough-in (see I as reference).
- 4) Dimensions subject to change without notice.