

Assembly Instructions

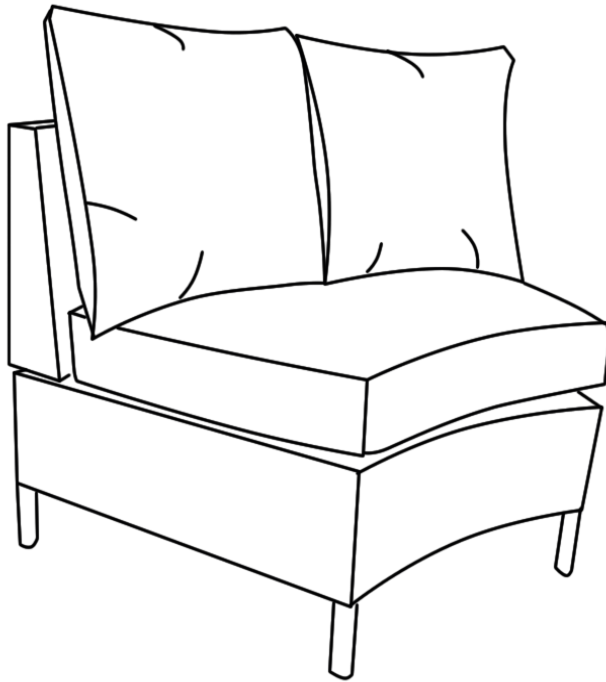

Caution : You must read this before you proceed

Sofa





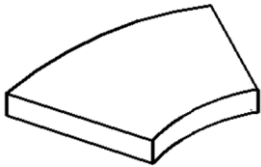

Parts List

Label	Picture	Description	QTY
A	A line drawing of a curved backrest piece, showing its shape and thickness.	Backrest	1
B	A line drawing of a curved seat piece, showing its shape and thickness.	Seat	1





C		Seat Cushion	1
D		Back Pillow	2

Hardware

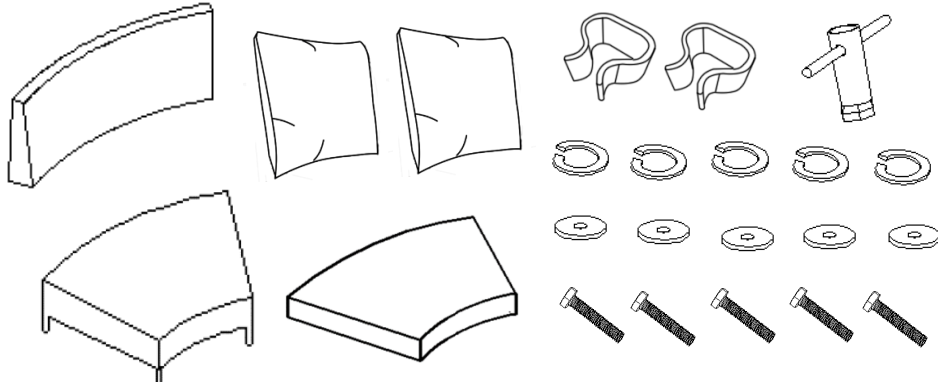
Label	Picture	Description	QTY
①		Box Wrench	1
②		Bolt (M8*45mm)	5
③		Spring Washer	5
④		Washer	5
⑤		Clip	2

Assembly Preparation

<p>Before Beginning Assembly:</p>	
-----------------------------------	--

-  • Read instructions, cover to cover-
-  • Have 2 adults on hand for assembly-
-  • Do not assemble on flooring or carpet-
-  • Assemble on a clean non-marring surface (packing foam)-
-  • Save all packaging until finished-

Assembly Steps

Overview

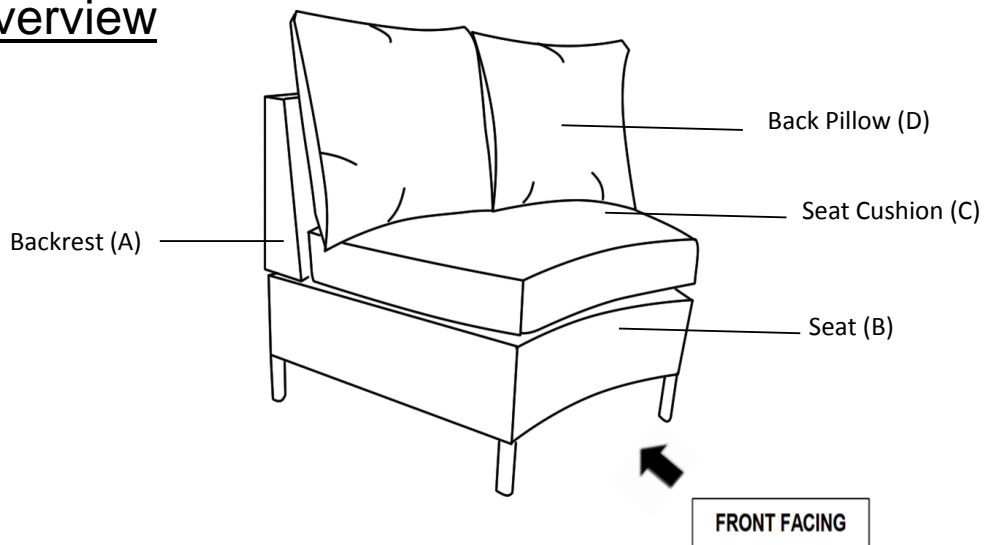

This Sofa has multiple parts and may require up to 30 minutes to assemble. To give you an overview of the Sofa parts, the above picture is to help you put the various parts into perspective. Please read through the instructions below to familiarise yourself with the parts and steps before assembly.

Step 1

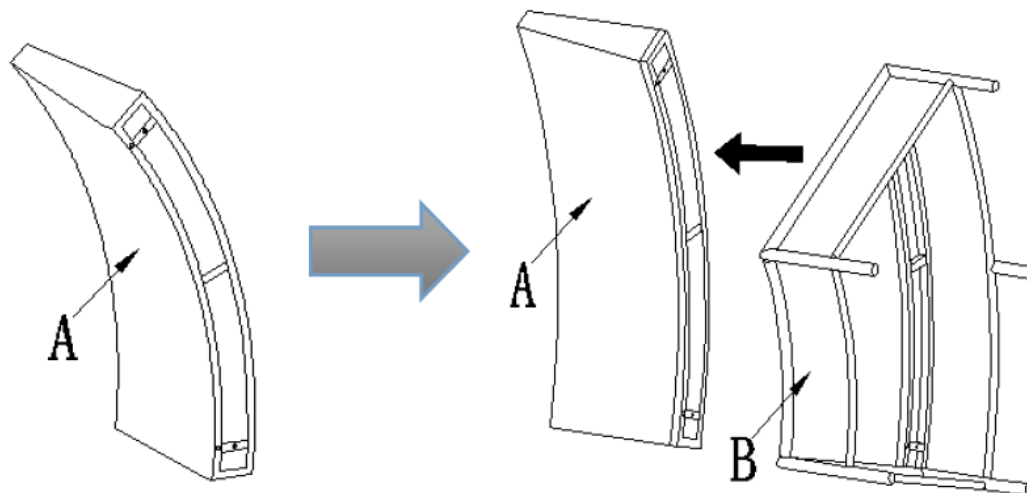

Open the carton and place all the parts onto a clean, non-marring surface. Place the Backrest(A) on its side, then align the Seat(B) to the Backrest(A) as pictured above.

This step should have a partner to accomplish together.

Step 2

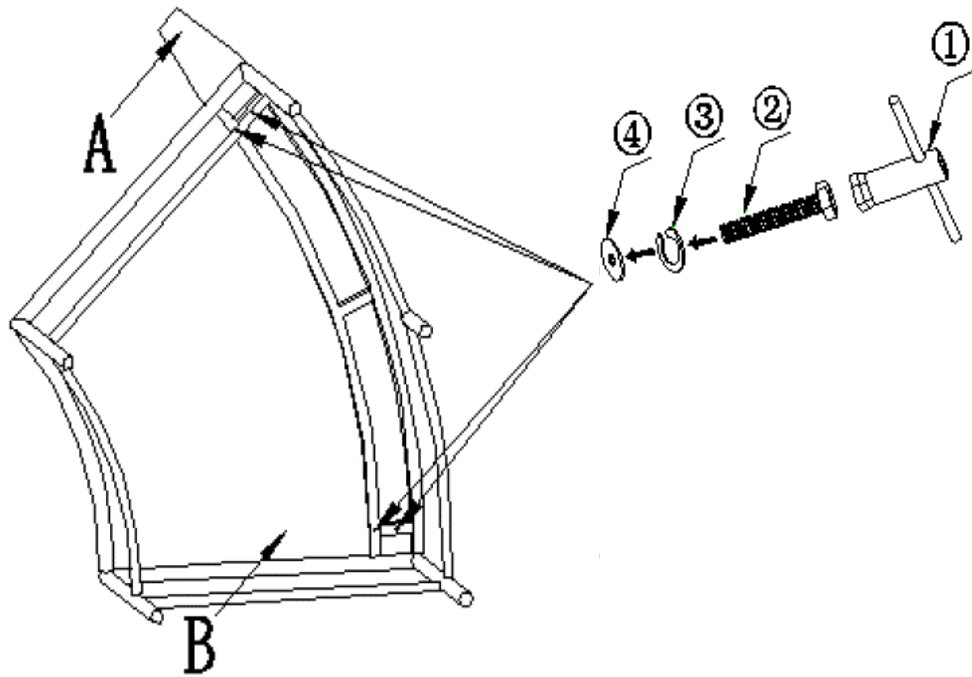

Attach Backrest(A) to Seat(B) using Bolts(2), Spring Washers(3), and Washers(4) with Box Wrench(1).

Tighten Bolts fully in a sequential manner after all Bolts are in place.

Step 3

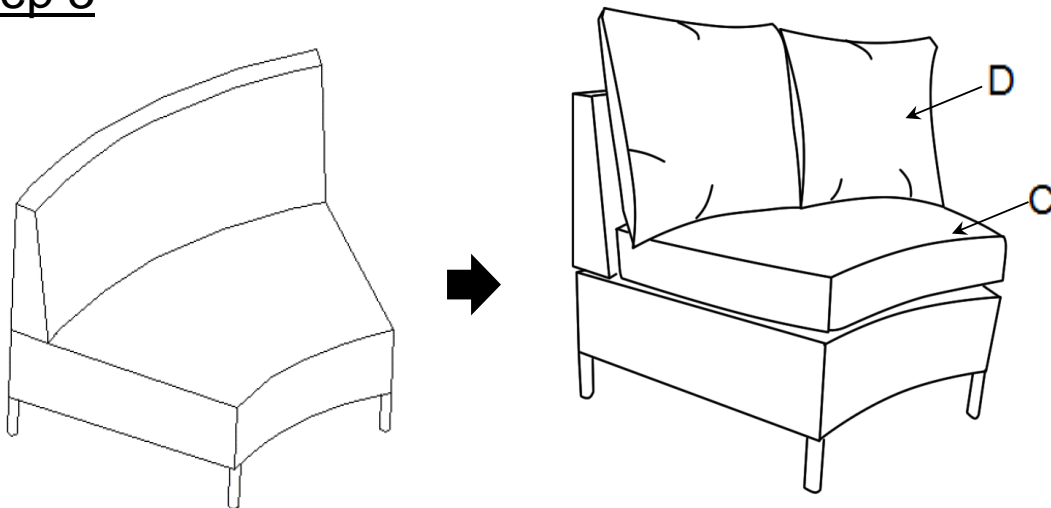

Stand the Sofa upright.

Put the Seat Cushion(C) & Back Pillow(D) on the Sofa.

Your Sofa is ready for use.

This Sofa can only be used on a flat, level surface.



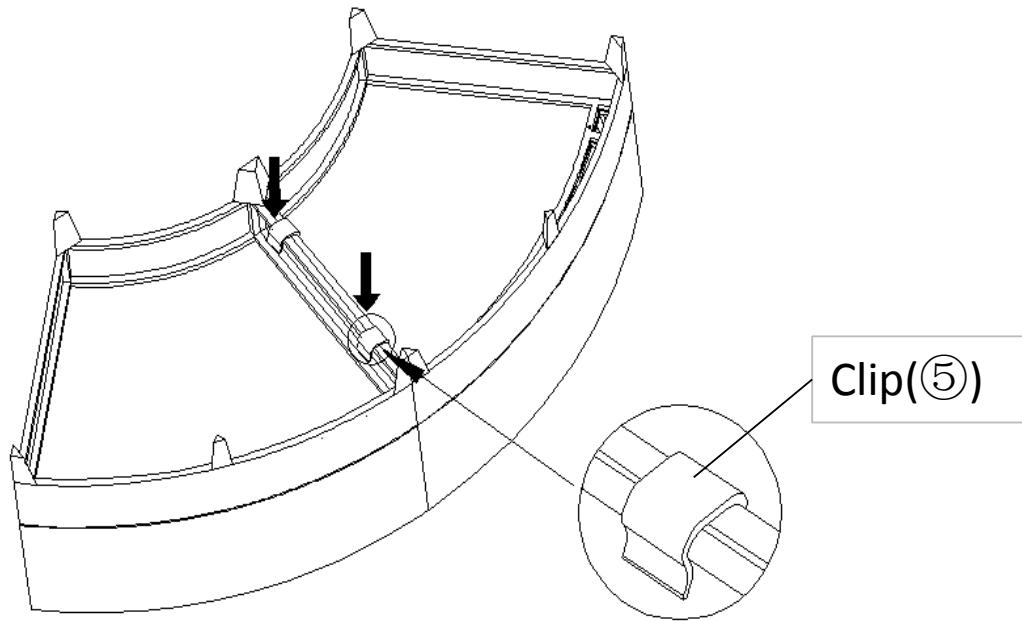

















Additional Hardware :



In the event that you should purchase more than one piece of this Sofa, the Connector Clips(5) can be used to link up the Sofas to achieve a Sectional Sofa.

Simply place the Sofas together and firmly push the Connector Clip(5) down until it locks into place.

Care & Maintenance

-   ● Do not put hot items directly on furniture surface
 -   ● Do not clean furniture with harsh cleansers or polish.
 -   ● To obtain the longest lifespan of your outdoor products, minimizing exposure to direct sunlight is recommended.
 -   ● Children should not climb or jump on the furniture.
 -   ● Do not write on furniture without a padded barrier to protect the surface.
 -   ● To obtain the longest lifespan of your outdoor products, avoid extended and lengthy exposure to rain, snow, and direct sunshine. Whenever possible cover the product and /or place under patio or awnings.
 -   ● Not for commercial use. For residential use only .
 -   ● Stains may be removed with mild soap solution and damp cloth.
 -   ● Keep away from sources of ignition.
-
-   ● Dust and pick-up spills using a clean, non-colored, lint-free cloth.