

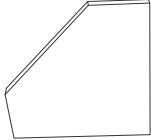

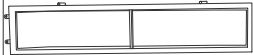



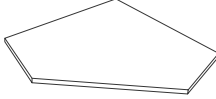

ASSEMBLY INSTRUCTION

(DON'T FULLY TIGHTEN THE SCREWS BEFORE FINISHING ASSEMBLY)

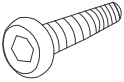
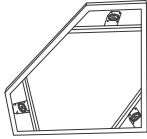
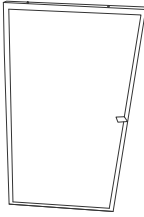
COMPONENTS:

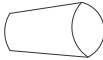
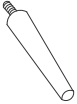
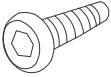
| | | | | | | |
|--|---|---|--|---|--|--|
| A) 1PC  | E) 1PC  | G) 1PC  | I) 1PC  | K) 1PC  | M) 1PC  | |
| B) 20PCS  | F) 1PC  | H) 1PC  | J) 1PC  | L) 1PC  | N) 3PCS  | |
| C) 4PCS  | D) 1PC  | | | | | |

STEP1

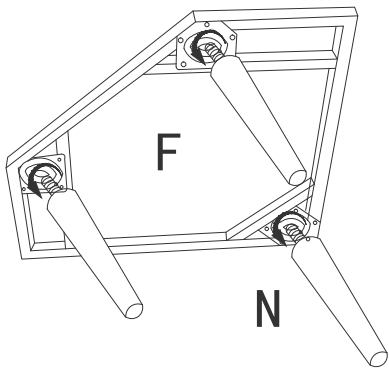

STEP2

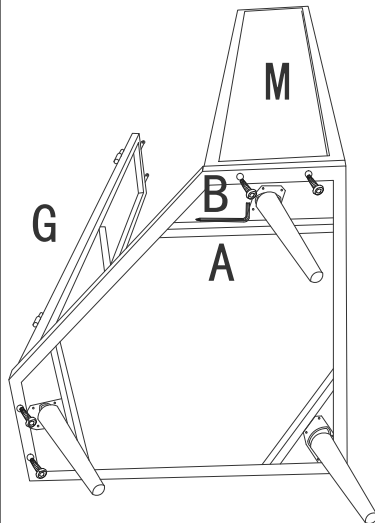

STEP3

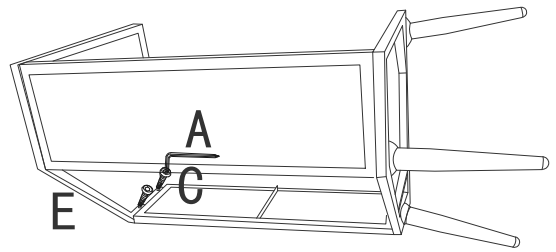

STEP4

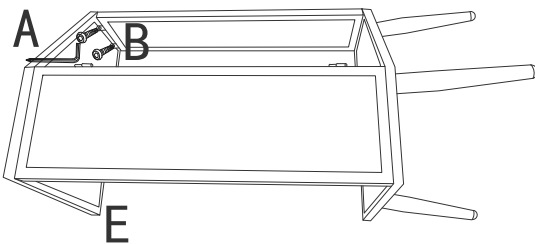

STEP5

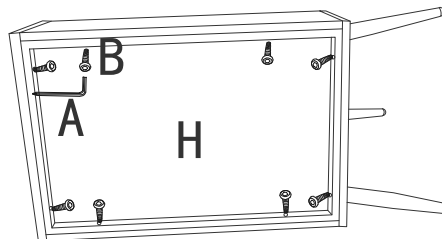

STEP6

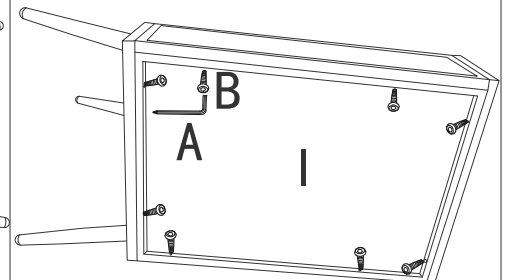

ASSEMBLY INSTRUCTION

(DON'T FULLY TIGHTEN THE SCREWS BEFORE FINISHING ASSEMBLY)

COMPONENTS:

STEP7

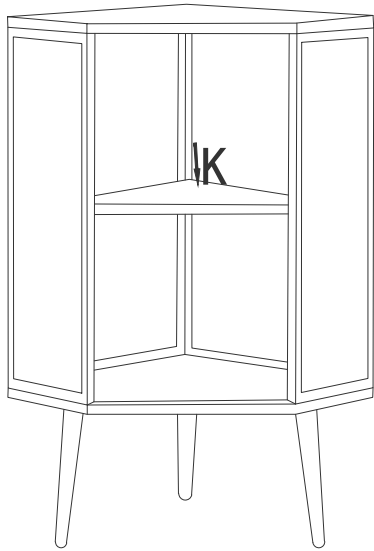

STEP8

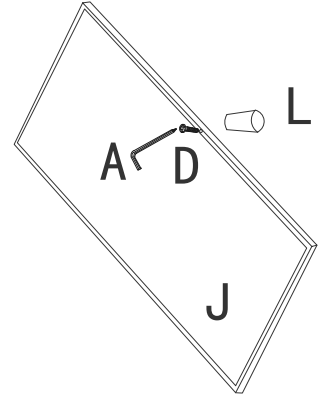

STEP9

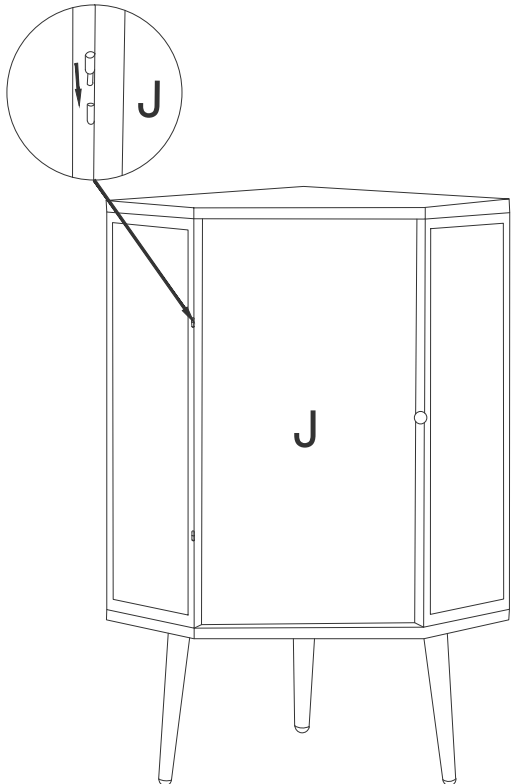

STEP10

