

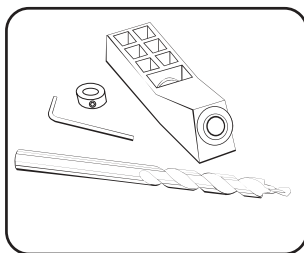

# **POCKET HOLE SYSTEMS™**

## ***Instruction Manual***



**Mini Kreg Jig®**  
(Models MKJ and MKJ Kit)

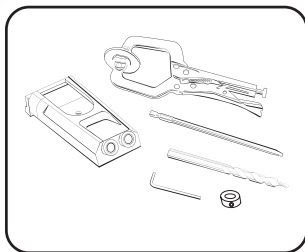

**Rocket™ Jig**  
(Models R1 and R2)  
US Pat. # 5,676,500

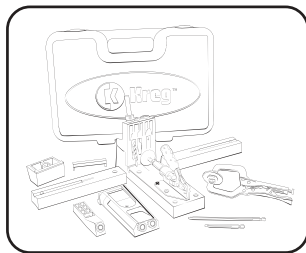

**Kreg Jig® ProPack**  
(Models K2000 and K2000-PP)  
US Pat. # 6,481,937

<i>Warnings and Cautions</i>	2
<i>Parts Identification</i>	3-4
<i>"Quick-start guide" to building your first Pocket Hole joint</i>	5-6
<i>The K2000 Kreg Jig®</i>	7-10
<i>The Rocket™ Jig</i>	11-12
<i>The Mini Kreg Jig®</i>	13-14
<i>Selecting the correct Pocket Hole screw</i>	15-18
<i>Joinery Guide</i>	
<i>Face Frames</i>	19-20
<i>Leg and Rail</i>	21-22
<i>Miters</i>	23-24
<i>Angles and Curves</i>	25-26
<i>Edgebanding</i>	27
<i>Edgejoining</i>	28
<i>Plugging a Pocket Hole</i>	29
<i>FAQ's</i>	30-33
<i>Warranty and Contact Information</i>	34

Thank you for your purchase! Kreg Tool Company is proud to manufacture top quality tools and accessories that are surpassed only by our commitment to customer service. If after reviewing this manual you still have a question or concern that you would like addressed please visit our website at [www.kregtool.com](http://www.kregtool.com), call 800-447-8638 or email [customerservice@kregtool.com](mailto:customerservice@kregtool.com). This manual covers the basics of pocket hole joinery including the Mini Kreg Jig®, Rocket™ Jig and the K2000 Kreg Jig®. In addition, a joinery guide located towards the back of the manual details the basics for producing a variety of wood joints utilizing pocket hole joinery.

KREG offers various educational materials to help you get the most out of your pocket hole tools. Over 15 different Pocket Hole project plans are available as well as the following video titles.

*The Pocket Hole Solution to Cabinetmaking (bookset also available)*

*The Pocket Hole Solution to Tables*

*The Pocket Hole Solution to Building Your Own Router Table*

*Pocket Hole Tips and Techniques*

## Warnings and Cautions

**CAUTION!** : *Handle drill bit carefully - Like any cutting tool, flutes of drill bit are extremely sharp.*

*Never hold a pocket hole jig by hand while drilling holes. Always secure jig and workpiece to an immovable object before drilling.*

*Always check drilling depth in scrap material before producing final pocket holes and driving screws.*

*Make sure material is securely clamped into jig before drilling.*

*Always allow drill bit to reach full speed before plunging into the workpiece.*

# Parts Identification

**K** – indicates what is included in package



Mini Kreg Jig®  
(MKJ)



Mini Kreg Jig® Kit  
(MKJ KIT)



Rocket™ Jig  
(R1)



3/8" Step Drill Bit  
(KJD)



3" - #2 Square Driver Bit  
(D3)



6" - #2 Square Driver Bit  
(D6)

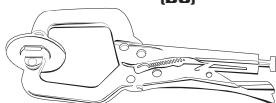

Standard Face Clamp  
(SFC)



Allen Wrench - 1/8"  
(AW18)



Depth Collar  
(KJDC)



75 Pack 1-1/4" Coarse Screws  
(SML-C125)



75 Pack 1-1/4" Fine Screws  
(SML-F125)



25 Pack 1-1/4" Fine Screws  
(SML-F125)

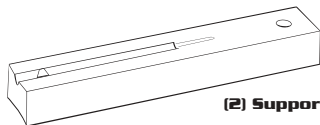

(2) Support Wings



Plastic Carrying Case  
(K2000 Case)

	<b>K</b>	
	<b>K</b>	
	<b>K</b>	























**Rocket™ Jig Kit**  
(R2)



**K2000 Kreg Jig®**  
(K2000)



**Kreg Jig® ProPack**  
(K2000-PP)

## Three Steps to Your First Pocket Hole Joint

Ready to jump in and start building? Here is a quick-start guide to creating your first pocket hole joint.

### Before you start... a few Pocket Hole Joinery Facts

- You only need to drill a pocket hole into **ONE** of the workpieces to be joined. No pre-drilling of the second workpiece is required with the use of self-tapping screws.
- The step drill bit forms both a pocket hole for the screw head and a guide hole for the screw shank in one motion.
- Gluing the joint is optional.
- Simply clamp the two workpieces to be joined to hold flush alignment and drive the screw.

1

### STEP 1 - Set the drilling depth.

(this example assumes using 3/4" thick material)

**(CAUTION! Drill bit flutes are extremely sharp! Handle with care.)**

The first step in creating a pocket hole joint is to set the drilling depth of your drill bit. Drilling depth is adjusted by changing the location of the depth collar on the shank of the drill bit. For joining 3/4" thick test pieces, place the depth collar onto the shank of the drill bit. Use a tape measure to position the depth collar 3-1/2" from the **STEP** of the drill bit. Tighten the depth collar in this position with the allen wrench provided.

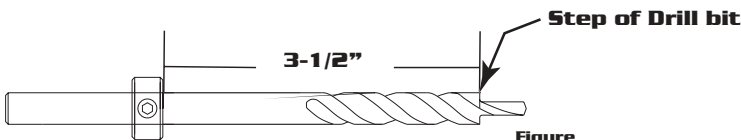

TIP

Setting the depth collar closer to the **STEP** of the drill bit will result in less screw travel into the second workpiece, moving the depth collar further from the **STEP** of the drill bit will result in more screw travel.

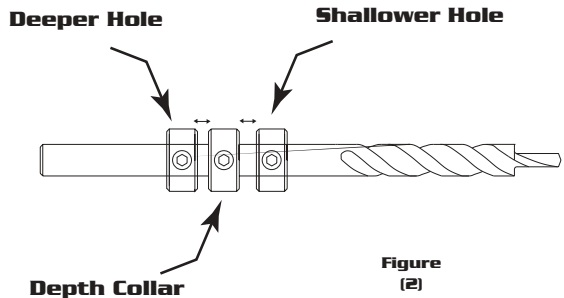

## STEP 2 - Prepare workpieces and drill the pocket holes.

Prepare materials by squaring the pieces to be joined on all edges. Place the drill bit into your drill and tighten securely. Place one workpiece to be joined onto the base of the K2000 Kreg Jig® as shown in Figure 3. Adjust the clamping pressure of the toggle clamp by turning the plastic pad to firmly hold the workpiece into the jig. Next, place the first 1-1/2" of the drill bit into any one of the three drill guides making sure that the tip does not come in contact with the workpiece. Bring the drill bit up to full speed and slowly plunge the drill bit into the drill guide until the depth collar reaches the top of the guide as shown in Figure 4. Remove drill bit and repeat the process in a second drill guide. Once drilling is complete, unclamp and remove workpiece from jig, gently tapping the workpiece to remove any remaining wood chips from the holes you have just created.

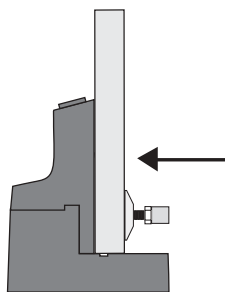

Figure (3)

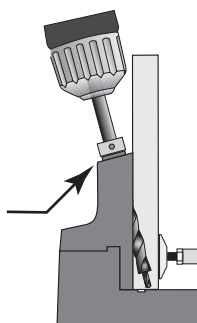

Figure (4)

## STEP 3 - Drive screws to secure the joint.

At this time, choose the correct screw length for your application. If you are joining 3/4" material to 3/4" material, a 1-1/4" length screw is suggested. Add glue to the joint line if desired. If you are joining the two pieces in a flat plane, such as a frame, position the large pad of the KREG Face Clamp™ over the joint line and clamp with firm pressure to hold them perfectly flush.

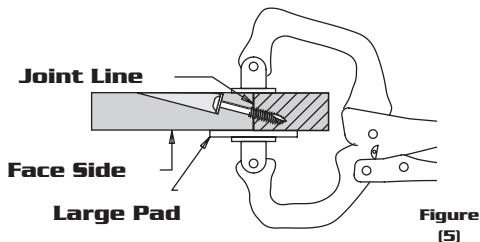
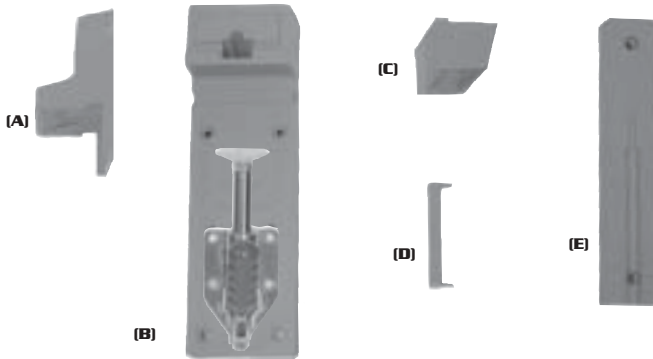

Figure (5)

Place the self-tapping screws down into the pocket hole and drive with a cordless drill until tight. Your joint should be tight, flush and extremely strong. If you encounter any problems, consult our FAQ section that begins on page 30.

## Setting up – K2000 Kreg Jig®

The K2000 Kreg Jig® consists of 5 main components: the upright (A), base (B), K2000 riser block (C), step block (D) and two identical support wings (ProPack only) (E).



Before drilling any holes you must first assemble the 1/4" hex nut into the base of the jig. Turn the jig over so that the toggle clamp faces away from you, next place the 1/4" hex nut loosely into the hex recess on the base of the jig. Finally, place the blue plastic nut retainer over the ribs of the opening and press into place to capture the hex nut (you may need to tap the retainer with a rubber mallet to fully seat it into position).

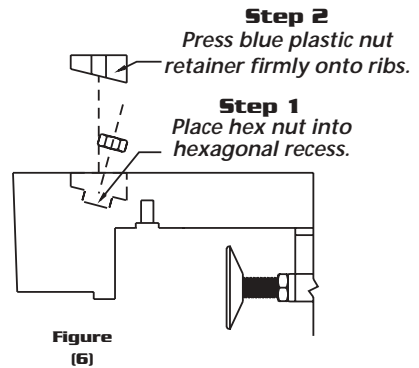

Figure (6)

### What size of board should I mount my K2000 to?

Mounting the K2000 Kreg Jig® to a piece of scrap wood is a good way to ready it for use and allow it to be easily removed from your work area to hang on a wall or shelf. We recommend cutting a 3/4" thick piece of plywood to approximately 13" X 24". This will allow you to space the support wings about 1" from each edge of the jig as shown FIG 7. The K2000 Kreg Jig® can also be mounted directly to a workbench.

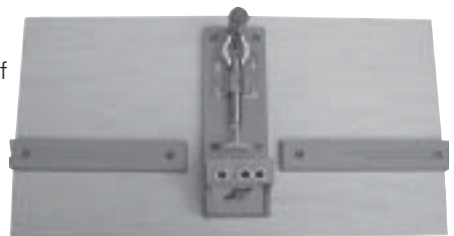

Figure (7)



The K2000 Kreg Jig® is designed with standard settings that allow one to easily join 1/2", 3/4" and 1-1/2" thick material. These three material thicknesses account for approximately 90 percent of the materials commonly used today in woodworking. If your material thickness falls between one of the standard settings, for example 1-1/4" stock, simply use the setting closest to your material thickness or build your own spacer block as shown on page 10.

1/2

### To join 1/2" thick material.

1. Attach upright to base of jig with short T-bolt provided.
2. Press step block into groove on the base of the jig.
3. Set depth collar to 3-5/16" from the **STEP** of the drill bit.
4. Rest material on step block, adjust toggle pressure and clamp into place.
5. Drill pocket hole. Use 1" screw to join 1/2" to another 1/2" thick workpiece.

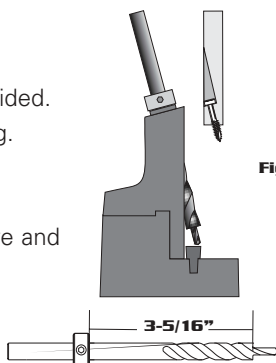

Figure (8)

3/4

### To join 3/4" thick material.

1. Attach upright to base of jig with short T-bolt provided.
2. Set depth collar to 3-1/2" from the **STEP** of the drill bit.
3. Rest material on base of jig, adjust toggle pressure and clamp into place.
4. Drill pocket hole. Use 1-1/4" screw to join 3/4" to another 3/4" thick workpiece.

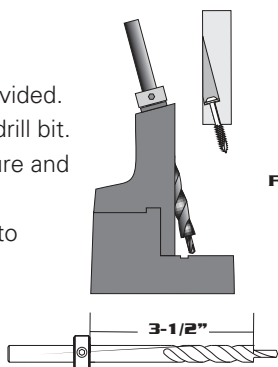

Figure (9)

1.5

### To join 1-1/2" thick material.

1. Attach riser block and upright to base of jig with long T-bolt provided.
2. Set depth collar to 4-1/4" from the **STEP** of the drill bit.
3. Rest material on base of jig, adjust toggle pressure and clamp into place.
4. Drill pocket hole. Use 2-1/2" screw to join 1-1/2" to another 1-1/2" thick workpiece.

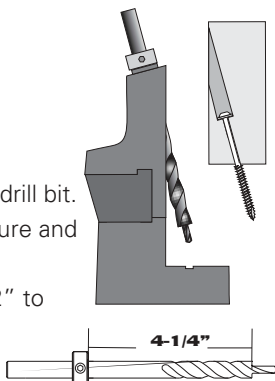

Figure (10)

**Adjusting the K2000 Kreg Jig® for Material Width**

Spacing pocket holes across the width of a workpiece is important in maximizing the strength of a joint. When framing most woodworking projects, it is recommended to place two pocket holes across the width of a rail to keep the workpiece from twisting once it has been assembled. The patented three-drill guide fixed spacing of the K2000 makes it extremely easy to place two pocket holes in a workpiece without having to unclamp and move the workpiece to drill the second hole. A real timesaver when working with a variety of wood widths. We recommend using the drill guide spacings indicated below for each rail width. For very wide pieces such as panels, we recommend placing a pocket hole every 6-8 inches across the length of the panel. Use any of the three drill guides to form the pocket on panels.

B-C

[ USE B & C SPACING  
ON 1-1/4" TO 1-3/4"  
MATERIAL ]

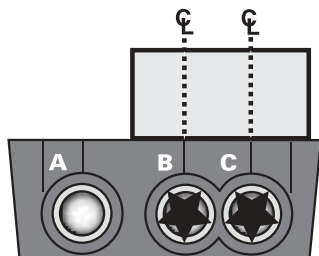

Figure  
(11)

A-B

[ USE A & B SPACING  
ON 1-3/4" TO 2-3/4"  
MATERIAL ]

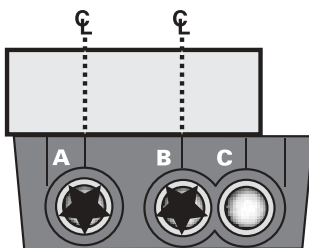

Figure  
(12)

A-C

[ USE A & C SPACING  
ON 2-3/4" TO 3-3/4"  
MATERIAL ]

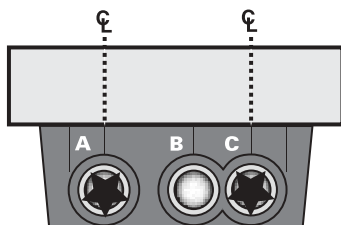
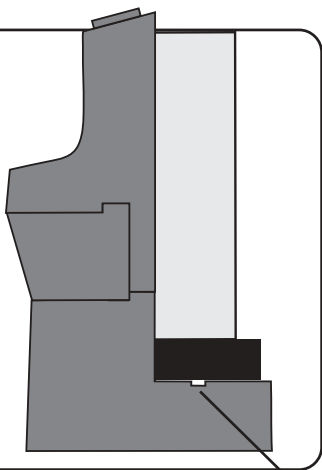

Figure  
(13)

**TIP**

**Pocket Hole Placement Tip!**

Although the K2000 Kreg Jig® is designed to work with three of the most common material thicknesses, a homemade spacer can always be added to the base of the jig to position a pocket hole in any thickness of material. Just remember that a 1/8" change in spacer height will move the exit point of the screw 1/24" on the workpiece. Always check the amount of screw travel in a scrap piece of material.



**Spacer**

**Using the K2000 Kreg Jig® portably.**

What happens when you want to drill pocket holes in a large 4' x 8' sheet of plywood? No need to try and manhandle the large piece into an upright position, just simply lay the plywood onto a workbench with the last 12" or so overhanging the edge of the workbench. Detach the K2000 Kreg Jig® from its mounted position and clamp it directly to the edge of the plywood as shown in FIG 14.

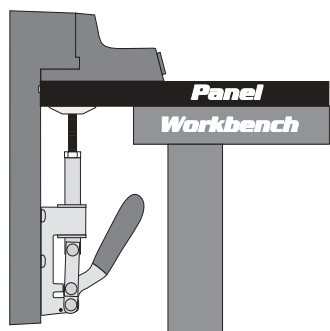
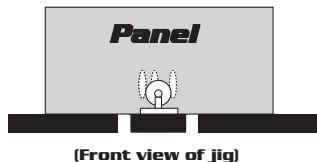

**Figure (14)**

**How to use the Support Wings.**

The Kreg Jig® ProPack includes two identical support wings that serve two purposes.

1. When placed in-line with the base of the jig they hold large panels perpendicular to the drill guides to assure accurate pocket hole placement.



**(Front view of jig)**

2. They feature depth collar set-up gauges that help to quickly set drilling depths for various material thicknesses. (Always set the **STEP** of the drill bit to the mark on wing for accurate depth).

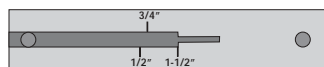

**(Top view of support wing)**

# Setting up the Rocket™ Jig

The Rocket Jig consists of 3 main components; the upright (A), base plate (B) and Rocket riser block (C). Two (2) 3/4" screws and two (2) 2-1/2" screws are included to assemble the 3 components in different configurations for drilling.

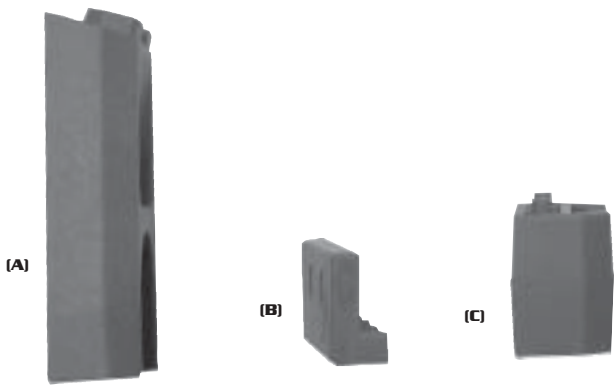

## Rocket™ Sliding Base Plate

The Rocket™ Jig utilizes a sliding base plate which allows the Kreg Face Clamp™ to slide into the recess on the back of the jig and secure it to the workpiece while drilling the pocket holes. The Face Clamp™ can then be removed and used to assemble the joint as shown below. In addition the Rocket™ Jig features a mounting hole that allows you to temporarily attach the tool to any workpiece in any location by simply driving a screw. A nice feature in situations where pocket holes could normally not be used because of a clamping obstacle.

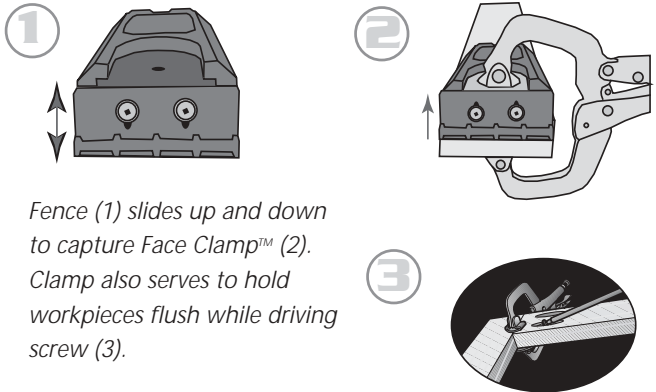

Fence (1) slides up and down to capture Face Clamp™ (2). Clamp also serves to hold workpieces flush while driving screw (3).

The Rocket™ jig is similar to the K2000 Kreg Jig® in that it allows you to maximize joint strength across a wide range of material dimensions by adding modular blocks to the base of the jig. These blocks adjust the exit point of the screw to easily work with 1/2", 3/4" and 1-1/2" thick material.

1/2"

### To join 1/2" thick material.

1. Attach base plate to upright with step facing up and towards the drill guides as shown at right. Use the 3/4" screws provided to tighten so the base plate slides freely.
2. Set depth collar to 3-5/16" from the **STEP** of the drill bit.
3. Secure workpiece to a stationary object such as a workbench. Place jig on workpiece referencing off of the step. Clamp jig securely to workpiece with Face Clamp™.
4. Drill pocket hole. Use a 1" screw to join 1/2" to another 1/2" thick workpiece.

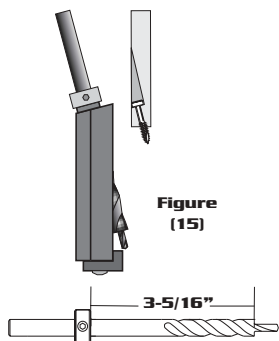

Figure (15)

3/4"

### To join 3/4" thick material.

1. Attach base plate to upright with step facing down and towards the drill guides as shown at right. Tighten the 3/4" screws provided so base plate slides freely.
2. Set depth collar to 3-1/2" from the **STEP** of the drill bit.
3. Secure workpiece to a stationary object such as a workbench. Place jig onto workpiece referencing off of the base plate. Clamp material to jig with Face Clamp™ or similar clamp.
4. Drill pocket hole. Use 1-1/4" screw to join 3/4" to another 3/4" thick workpiece.

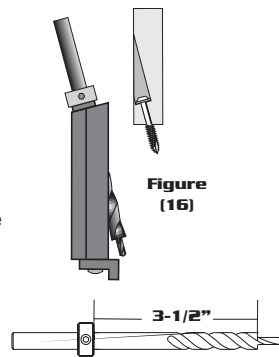

Figure (16)

1.5"

### To join 1-1/2" thick material.

1. Attach riser block and base plate to upright with step of base plate facing down and towards the drill guides as shown at right. Tighten the pieces using the 2-1/2" screws provided so that the base plate still slides freely.
2. Set depth collar to 4-1/4" from the **STEP** of the drill bit.
3. Secure workpiece to a stationary object such as a workbench. Place jig onto the workpiece referencing off of the base plate, clamp material to jig with Face Clamp™.
4. Drill pocket hole. Use 2-1/2" screw to join 1-1/2" to another 1-1/2" thick workpiece.

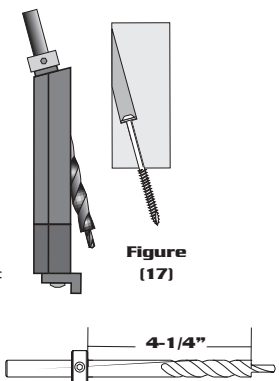
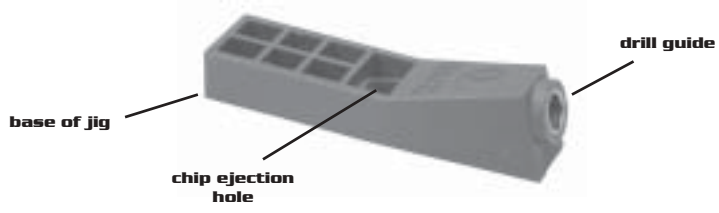

Figure (17)

# Setting up the Mini Kreg Jig®

The single drill guide Mini Kreg Jig® is our most positionable pocket hole tool. The jig is designed without an alignment fence which allows it to be clamped at virtually any angle or orientation to the edge of a workpiece. Great in situations where the project is already assembled and in need of an extra pocket hole or in repair applications such as tightening a chair or table leg to the leg.



### Plug Setting Feature

The Mini Kreg Jig® features a recess on the bottom of the tool that is helpful in seating pocket hole plugs. Simply start the plug into the pocket hole and push into position with the base of the tool. Saves wear and tear on your hands!

Figure (18)

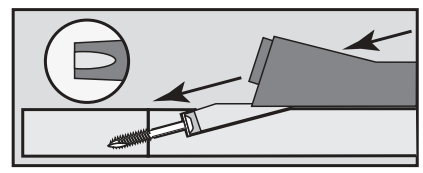

Setting a plug with the Mini Kreg Jig®

### TIP

*The Mini Kreg Jig® comes in handy in repair applications and space constrained areas. One of the most popular uses of the jig is to tighten a wobbly chair or table leg as shown in the images at right without having to spend time re-gluing, clamping, etc.*

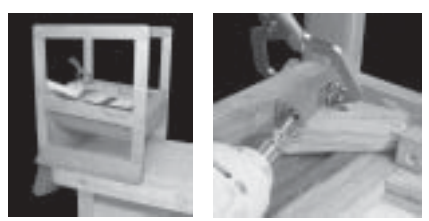

## Using the Mini Kreg Jig®

Positioning the Mini Kreg Jig® to center a screw in various material thicknesses is accomplished by setting the base of the jig a given distance from the edge of the workpiece. (Be sure to clamp the jig to the workpiece before drilling)

1/2

### To join 1/2" thick material.

1. Clamp the workpiece to be drilled to a stationary object such as a workbench.
2. Set depth collar to 3-5/16" from the **STEP** of the drill bit.
3. Position the base of the jig 3/8" over the edge of the workpiece as shown at right. Clamp jig to material with Face Clamp™.
4. Drill pocket hole. Use 1" screw to join 1/2" to another 1/2" thick workpiece.

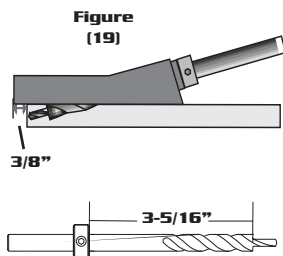

3/4

### To join 3/4" thick material.

1. Clamp the workpiece to be drilled to a stationary object such as a workbench.
2. Set depth collar to 3-1/2" from the **STEP** of the drill bit.
3. Position the base of the jig flush with the edge of the workpiece as shown at right. Clamp jig to material with Face Clamp™.
4. Drill pocket hole. Use 1-1/4" screw to join 3/4" to another 3/4" thick workpiece.

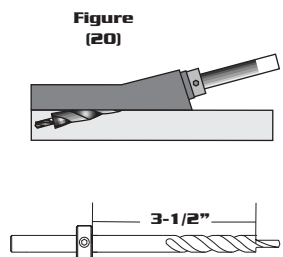

1.5

### To join 1-1/2" thick material.

1. Clamp the workpiece to be drilled to a stationary object such as a workbench.
2. Set depth collar to 4-1/4" from the **STEP** of the drill bit.
3. Measure and set the base of the jig back 1-1/4" from the edge of the workpiece as shown at right. Clamp jig to material with Face Clamp™.
4. Drill pocket hole. Use 2-1/2" screw to join 1-1/2" to another 1-1/2" thick workpiece.

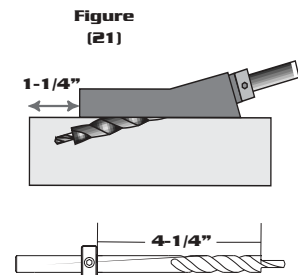

## Selecting the Correct Screw

*KREG self-tapping screws are specially designed for pocket hole joinery. They feature a self-tapping auger point that eliminates pre-drilling and a flat head that seats flushly in the bottom of the pocket hole. All of our screws utilize a #2 square drive recess. The deep recess of the square drive provides positive driver engagement to reduce cam-out. Like every KREG product, our screws are manufactured from the highest quality materials. To manufacture a virtually unbreakable screw, industrial quality steel is first case-hardened and then coated with a dri-lube finish which reduces driving torque and gives them their bronze appearance. Many of our screw types are available in a weather resistant coating that is approximately 10 times more corrosion resistant than a standard zinc plated screw.*

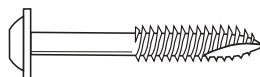

### Choosing the right screw...

We offer three thread types, two head styles and four different lengths to handle nearly all pocket hole applications. The characteristics for choosing the screw for your project are detailed below.

### Thread Types

A fine-thread screw is used any time you're driving the screw into a hardwood (i.e., oak, maple, walnut, cherry, hickory, etc.) The coarse-thread screw has a larger thread diameter and provides greater holding power when driving a screw into soft material such as plywood, particle board, MDF, melamine, and pine. We also offer a Hi-Lo thread type which consists of two separate threads, one higher than the other that serves as a general purpose screw in medium hardwoods like poplar. The Hi-Lo screw is only offered in the 1-1/4" length.

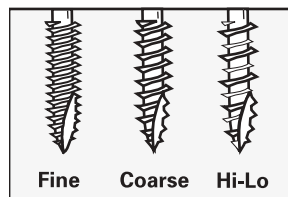

Figure (22)



## Head Styles

The washer head (SML) screw is our most popular head style as it provides the largest amount of surface area to seat firmly in the bottom of the pocket. Available in both fine or coarse thread, this head style is highly recommended if the material the pocket is drilled into is soft such as plywood or pine. The large washer head assures that the screw is not overdriven in the bottom of the pocket.

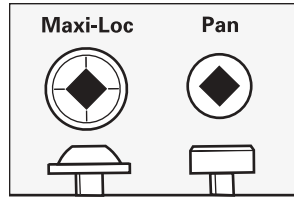

Figure (23)

The second available head style is the pan head (SPS). The pan head is slightly smaller in both head and shank diameter than the washer head screw and is a good alternative to the washer head screw if both mating workpieces are made of extremely hard woods. The pan head style is also of benefit in the 1" length as it allows one to join 1/2" stock and easily seat the screw head below flush.

## Screw Length

There are four thread lengths most commonly used in pocket hole joinery; 1", 1-1/4", 1-1/2" and 2-1/2". Choosing the correct screw length depends on the setting of your jig and the depth at which you drill the pocket hole. Many times you will be joining 3/4" material to 3/4" material, 1/2" material to 1/2" or 1-1/2" material to 1-1/2" material. The chart below helps you select the screw to use in these situations.

Figure (24)	Material Thicknesses Being Joined		
	1/2" to 1/2"	3/4" to 3/4"	1-1/2" to 1-1/2"
Hardwoods (Oak, Maple, Walnut, etc.)	*SPS-F1 SPS-F1 (W)	*SML-F125 SML-F125(W) SML-F150 SPS-F125 SPS-F125(W) SPS-F150	*SML-C250(W) SML-C250
Softwoods, (plywood, MDF, pine, etc.)	*SPS-C1 SML-C1	*SML-C125 SML-HL125 SML-C125(W) SML-C150 SML-C150(W)	*SML-C250(W) SML-C250

\* - denotes preferred screw type

(W) - denotes weather resistant coating

KEY	<p>SML = WASHER HD. SPS = PAN HD.</p> <p>F = FINE C = COARSE HL = HI- LO</p> <p>1 = 1" 125 = 1-1/4" 150 = 1-1/2" 250 = 2-1/2"</p>
-----	---

# Screw Penetration by Jig Setting

This chart illustrates the amount of screw penetration that will occur into the second workpiece in a given position of any Kreg Jig®.

**\*\*Always test in scrap material before driving final screws)\*\***

**1/2" Setting** - (1/2" material setting of any Kreg Jig®)  
Depth Collar set to 3-5/16" from the step of the drill bit.

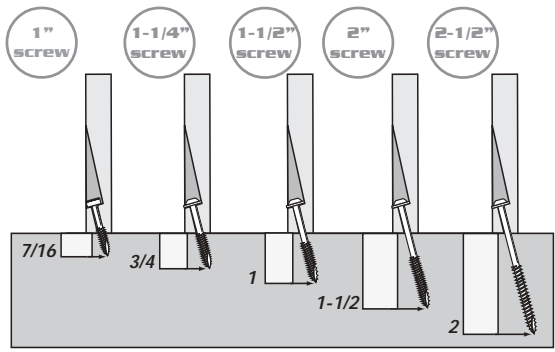

Figure (25)

**3/4" Setting** - (3/4" material setting of any Kreg Jig®)  
Depth Collar set to 3-1/2" from the step of the drill bit.

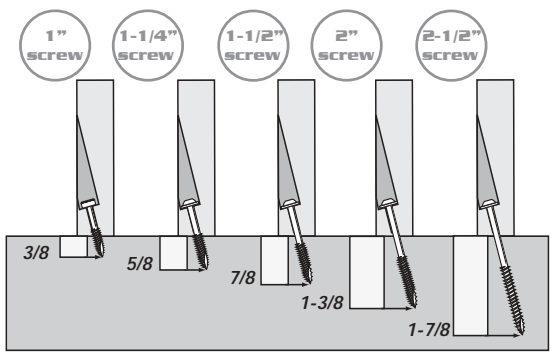

Figure (26)

**1-1/2" Setting** - (1-1/2" material setting of any Kreg Jig®)  
Depth Collar set to 4-1/4" from the step of the drill bit.

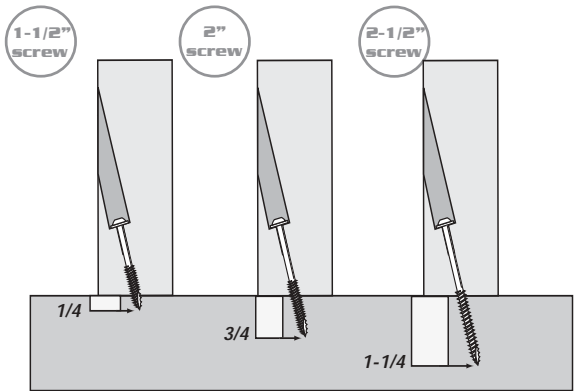

Figure (27)

### **What screw type (thread) should I use in hardwoods, softwoods?**

It is recommended to use a fine thread screw in hardwoods such as oak, maple, walnut, cherry, hickory, etc. Use a coarse thread screw in softer materials such as pine, plywood, melamine, MDF and particle board.

### **What screw length should I be using?**

As a general rule, when joining 3/4" stock to 3/4" stock you will use a 1-1/4" screw. When joining 1/2" to 1/2" material use a 1" screw, and to join 1-1/2" to 1-1/2" material use a 2-1/2" screw. A good way to test the amount of screw penetration into your second workpiece is to take a scrap piece of material that is the same thickness as the stock you will be actually joining and drill a pocket hole to the desired depth. Run a screw into the scrap piece. Now hold the scrap piece up to the second workpiece to visually verify penetration depth. Adjust for deeper or shallower thread penetration by changing the setting of the jig, moving the depth collar or using a different screw length. Refer back to the chart on the previous page for more screw penetration information.

### **My wood is splitting when driving the self-tapping screws.**

The first thing to check is the hardness of the material you're working with and the thread pitch of the screw. We always recommend using a fine thread screw in hardwoods such as oak, maple, hickory, cherry, walnut and a coarse thread screw in plywood, particle board, MDF, melamine, pine, etc. If you are already using a fine thread screw in hardwoods and are still having trouble, you may want to try our SPS-F125 or SPS-F150 screw. These screws have a slightly smaller shank size than the washer head screws (SML-F###). Lastly, whenever you encounter problems with materials splitting it is advised to slow down the speed of the driver.

### **Heads are breaking off when driving the screws.**

Not all self-tapping pocket hole screws are created equal. Our screws are designed with a larger head than most common self-tapping screws making them much more likely to strip-out before the head of the screw breaks off. If you are having problems with the head breaking off in a box of KREG Pocket Hole Screws please let us know so we may make it right with you.

### **What screw should I use in 1/2" plywood?**

This is normally a drawer box assembly question. We recommend using the SPS-C1 screw. This is a pan head coarse thread screw. The pan head is smaller than the washer head screw and more easily seats below the surface of the 1/2" material. The coarse thread provides maximum holding power in plywood.

Frames are common to many types of woodworking projects from cabinets to entertainment centers, doors and more.

The thread that ties all of these applications together is that the workpieces are assembled in a flat plane.

Frames are commonly assembled from material as thin as 1/2" up to 2" thick. For cabinets, 3/4" thick material is the standard. The goal is to always use the setting of the Kreg Jig® that will allow you to place a pocket hole so that the screw will exit the mid-point of your material (ie. for 3/4" thick stock, you will want the screw to exit at 3/8" by using the 3/4" setting of the jig)



### Face Frame Components

**A. Rail** – Horizontal members of a face frame. Pocket holes are always placed into the rail so that the screw will be driven into the stile across the grain.

**B. Stile** – Vertical members of a face frame. Stiles capture the rail, that is, they run all the way from top to bottom and the rails fit in between.

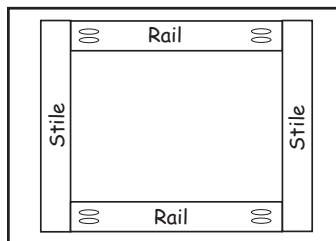

### Standard Face Frame Dimensions

A typical face frame measures 31-1/2" tall by approximately 24" wide when assembled. You can just as easily build a face frame to custom dimensions such as 31-1/2" tall by 48" wide with pocket hole joinery. Rail and stile widths typically range from 1-1/2" to 2-1/2" wide.

### Steps to Building a Face Frame

#### 1. Plane wood to thickness, rip to width and cut square to length.

Planing your wood to the same thickness assures that you will produce flush frames without a great deal of sanding once assembled. Cutting your materials accurately will greatly affect overall squareness as a pocket hole joint will pull the workpieces into alignment with the cut edge. (An untrue cut will be pulled into untrue alignment!)

## 2. Layout and mark your workpieces.

We recommend that you layout your cut workpieces on a workbench and mark each piece on the side that will receive the pocket holes. Measure corner to corner for square.

## 3. Drill pocket holes in both ends of rails.

Prepare the jig you will be using to center the screw in the material thickness being joined and set your depth collar accordingly (see jig instructions). You will want to place at least two pocket holes across the backside of the rail to make sure that it will not twist once assembled.

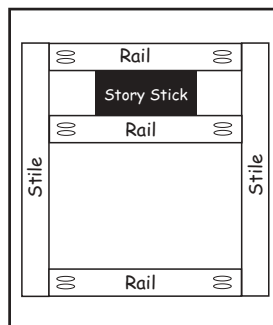

## 4. Position rails into alignment with reference marks on stile.

After the pocket holes have been drilled into the rails, place the workpieces into final alignment on a workbench or assembly grid. If your face frame will have a drawer bank, a good way to reference the size of the opening is to cut a story stick to size that will allow you to consistently and accurately place the intermediate rail.

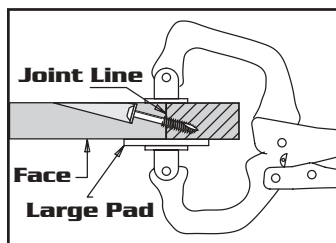

## 5. Clamp over joint line and drive screws.

No pre-drilling is required of the stile as long as you are using a self-tapping wood screw. Add glue to the joint line at this time if desired. Place the KREG Face Clamp or Bench Clamp on the joint line to hold the rail and stile perfectly flush as the screws are driven.



*Occasionally in very hard or dry material you may split the very top or bottom of a rail when driving a screw. To combat this try cheating the pocket hole on the rail so they are further from the edge of the stile. Another tip is to use a #6 shank size screw such as the SPS-F125 as opposed to the standard SML-F125 which is a #7. Another option is to use only one pocket hole per rail end if necessary.*

The Leg and Rail joint is a standard with table and chair assembly. Design options include either a set-back or flush rail. Use corner braces or a gusset to stiffen the joint. Pocket holes can also be drilled upwards into the rail to attach the table top at a later time.



### Leg and Rail Components

- A. Leg** – The main vertical support that extends all the way to the floor. Can be turned, square, rectangular or tapered.
- B. Rail** – Horizontal members that are screwed into the Leg.
- C. Gusset or corner brace** – Squaring / support blocks that reinforce the joint.

### Standard Leg and Rail Dimensions

Tables and chairs come in various sizes but all incorporate a Leg and Rail connection. Legs can be purchased pre-turned, as furniture squares or laminated from thinner pieces of stock. Typical finished leg sizes range from 1-1/2" to 6" square. Rail widths will vary according to the size of the leg and overall length of the table or chair. 3/4" thick rails are very common in coffee tables, end tables and sofa tables while thicker rails may be found on dining tables.

### Steps to Building a Leg and Rail Joint

#### 1. Buy or prepare legs for assembly.

One of the most economical ways to construct legs for coffee and end tables is by simply laminating two pieces of 3/4" stock together. Plane your material to the same thickness, rip square, clamp and glue overnight. Once dried, trim and cut to final length.

#### 2. Drill pocket holes into end of rail.

Normally two or three pocket holes across a 3" rail is sufficient. If you are planning on attaching the table or chair top through the rail it is recommended to drill the pocket holes upward into the rail at this time before final assembly to the legs.

### **Set-back Rail -**

A rail that is set-back from the edge of the leg to highlight a reveal is a very common way to dress up a table or chair and give the design depth and sophistication. This set-back is very easy to achieve with pocket hole joinery.

Cut a piece of material to the thickness of your desired set-back (1/4" plywood works well). Secure the leg to a workbench with a clamp. Butt the 1/4" plywood, or desired material, up against the leg at the location to be joined. Set the rail onto the plywood so it is raised off the workbench, clamp if desired and drive the screws.

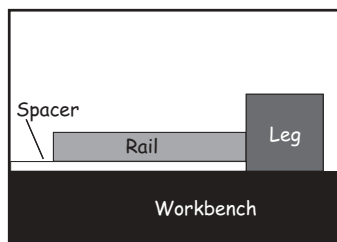

### **Flush Rail -**

This is the simplest form of a leg and rail connection where the rail is attached perfectly flush to the edge of the leg.

Secure the leg to a flat workbench with a clamp. Butt the rail up against the leg at the location to be joined making sure the top edge of the rail is flush with the top of the leg. Clamp the rail to the workbench if desired and drive the screws.

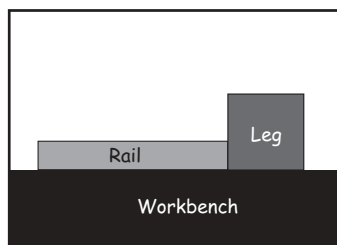

### **Gusset Supports -**

A great way to add strength and square up a corner.

On a typical table with a 2" square leg and a 1/4" set-back rail you will want to first create a right triangle gusset with a 6-8" hypotenuse. Next cut a 1" by 1" square out of the corner. Take the finished gusset and place a pocket hole perpendicular to the short legs of the right triangle so that the screw will be driven directly into the rails (make sure to check the amount of screw penetration in a scrap workpiece before final assembly). You can also place a pocket hole into the corner of the gusset with the Mini Kreg Jig® to further tie it into the leg.

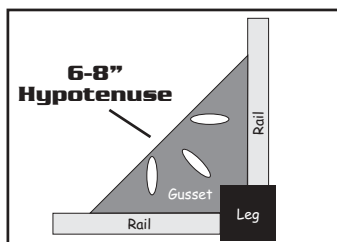

## Mitered Joints

*This section relates to mitered joints that are assembled in a flat plane such as a picture frame. This is probably one of the most challenging types of joints to produce with pocket hole joinery. Understanding how the orientation of the pocket hole and the width of the stock being joined varies will allow you to join frames more easily.*



### Miter Components

**A. Miter toe** – The outside point of a mitered workpiece.

**B. Miter heel** – The inside corner of a mitered workpiece.

**C. Rabbet** – This is typically a 3/8" wide by 1/2" deep L-shaped groove set into the edge of the frame that allows the backing material to be inserted.

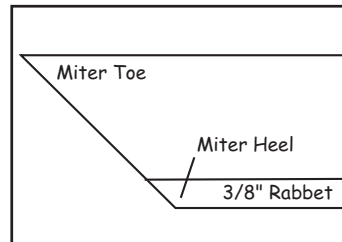

### Standard Miter Dimensions

A miter cut refers to anything other than a 90 degree cut. Two 45 degree miter cuts when assembled create a 90 degree joint, while two 30 degree angles will produce a 60 degree joint. To calculate the angles needed to make a hexagon, octagon, etc. simply take 360 degrees and divide it by the number of sides multiplied by two (ie. For an octagon take  $360 / (8 * 2) = 22.5$  degrees

Triangle	60 degrees	Heptagon	25.7 degrees
Square	45 degrees	Octagon	22.5 degrees
Pentagon	36 degrees	Nonagon	20 degrees
Hexagon	30 degrees	Decagon	18 degrees

Frames are typically made from 3/4" thick stock. Material width of frame members can range from 1-1/2" wide to 5" wide and beyond. One thing to keep in mind with pocket hole joinery is that the wider the frame members, the easier they are to join. Many frames also incorporate a standard 3/8" wide by 1/2" deep rabbet into the inside edge of the frame that serves to allow the glass, picture and backing material to be secured.



## Steps to Building a Miter joint

**1. Plane material to uniform thickness, rip to width and rout rabbet if desired.**

**2. Cut desired miter on workpiece and position to drill pocket holes.**

There are a few different ways to join mitered pieces with pocket hole joinery. This example below focuses on joining two 45 degree mitered pieces by placing two pocket holes across the workpiece perpendicular to the edge of the miter as shown in the image at right. The workpieces are 3" wide with a 3/8" rabbet along the inside edge.

**a.** Position one workpiece so that the edge of the miter rests entirely on the base of the jig and the drill guides will not interfere with the edge of the board or the rabbet as shown at right. On this 3" wide piece, use the A-C setting of the K2000 Kreg Jig® or a 1-1/2" center to center pocket hole spacing.

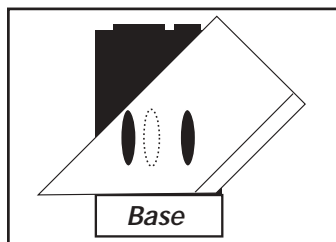

**b.** If your workpiece is less than 2" in width, you may need to raise the heel of the miter off of the base of the jig slightly in order to get the entire impression of the pocket hole on the backside of the workpiece. Adjust drilling depth and screw length accordingly in this situation.

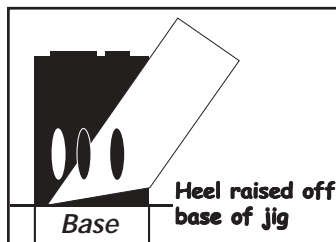

**3. Clamp and drive screws.**

You can use many different styles of clamps to hold the workpieces flush while the screws are driven. If you will be assembling a number of miter joints you may want to produce an assembly fixture to help hold the toes of the miters in perfect alignment. The fixture consists of a piece of plywood that has two hardwood pieces attached to it to form a perfect 90 degree angle. You can add an overhead clamp to this fixture to produce consistent clamping results.

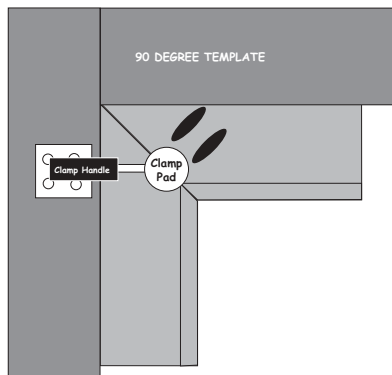

Angles and curves are a great application for pocket hole joinery. With other methods of joinery an angled joint must be held in alignment for a substantial amount of time with bar clamps. Uneven pressure along the joint line can result in bowing, gaps or misalignment. The pocket hole joint solves this by putting constant pressure along the joint line in the form of screws that pull the two flat surfaces tightly together.

A typical 45 degree angle such as what you might find on an angled cabinet face frame front is traditionally made by joining two 22-1/2 degree pieces. With pocket hole joinery this joint is constructed by cutting the entire 45 degrees on one workpiece and leaving the other piece as a 90 degree. These two workpieces are then aligned flush on their inside edges which leaves an overhang on the front side which can be taken off with a jointer, sander or hand plane once assembled (if you don't have a jointer, you can tip your table saw blade to 45 degrees, cut it close and then finish with a belt sander).

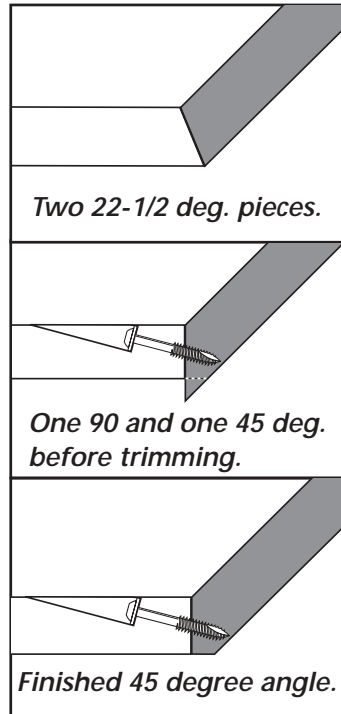

The result of this assembly method is that once the overhang is taken off the joint line is in effect "shifted" around the corner and hidden from view. The resulting solid wood corner is more resistant to wear and abuse because the mitered edges are no longer exposed on the edge. This same concept can be adapted to any angled joint application.

### Angle Components

- A. Angled Stile** – The workpiece that contains the entire desired angle cut on one edge.
- B. 90 degree Stile** – The second workpiece to be joined cut at a 90 degree angle on both edges.
- C. Assembly Jig** – A homemade fixture you will want to build that will help hold the inside edges of the two stiles aligned while the screws are being driven.

## Steps to Building an Angled Joint

**1. Plane stiles to same thickness, rip to width and cut square to length. Place desired angle on inside edge of one stile.**

**2. Build an assembly jig from scrap stock.**

We recommend that you first cut a plywood base 8" by 12". Next laminate two 3/4" x 4" x 12" hardwood pieces together with glue and then cut the block on an angle that will complement your desired assembly angle. Mount this angled piece to the plywood. Lastly, take your workpieces to be assembled, align them on their inside edges and measure the overhang that

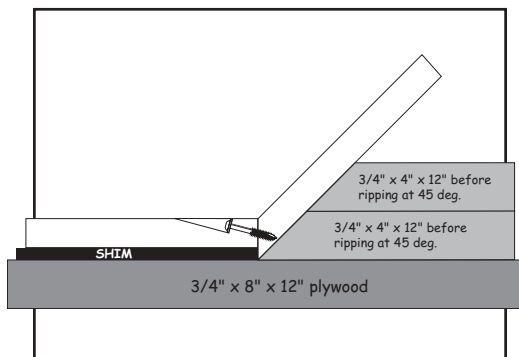

occurs. Make a shim the same height as the overhang measurement and attach this to the plywood base so that the edge butts up with the angled piece.

**3. Drill pocket holes into the edge of the 90 degree stile.**

Prepare the pocket hole jig you will be using to center the screw in the material thickness being joined and set your depth collar accordingly (see jig instructions). We recommend that you place pocket holes every 6-8 inches along the length of the stile. Test the drill depth and screw penetration in scrap workpieces that are the same thickness as your actual stock before final assembly. If the screw tip protrudes too far into the second workpiece you can simply set the depth collar closer to the step of the drill bit to create a shallower hole.

**4. Position stiles and drive screws.**

Apply glue at this time if desired. Work from one end as you slide the stiles across the assembly jig you have created. Press down onto the angled stile as you assemble to create a uniform overhang.

**5. Remove overhang from the front edge.**

Remove the overhang from the front edge of the workpieces with a jointer, sander or hand plane once assembled (if you don't have a jointer, you can tip our table saw blade to 45 degrees, cut it close and then finish with a belt sander).

Edgebanding, or placing a solid wood edge piece onto plywood or melamine to hide the unfinished edge is a great application for pocket hole joinery. Typically used for countertops, tabletops and shelves. In the past this process would be completed by either brad nailing the solid wood onto the plywood which would require time consuming filling and sanding of the brad holes, or simply gluing the solid wood onto the plywood and holding it in place overnight with bar clamps. Using pocket holes placed into the underside of the plywood to secure the hardwood creates an extremely fast and strong joint resulting from the large amount of clamping pressure exerted by the self-tapping screws.



### Edgebanding Components

- A. Edgebanding** — Typically a piece approximately 1" x 1-1/2" solid wood cut to correspond with the dimensions of the countertop/shelf. Often has a routed profile to soften the edges and add visual appeal.
- B. Plywood / Melamine** – (3/4" thick)

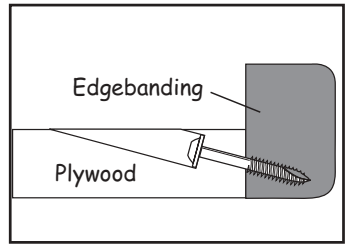

### Steps to assemble Edgebanding

- 1. Rip edgebanding to size. Rout desired profile. Cut to length.**  
Rip the solid wood piece to size making sure that all edges are square and true. Rout profile onto the stock at this time. Cut to length and dri-fit to plywood or melamine before assembling.
- 2. Drill pocket holes into plywood.**  
We recommend that you place pocket holes every 6-8 inches along the length of the plywood for adequate holding power.
- 3. Drive screws to assemble edgebanding.**  
Apply glue at this time before assembly. A great way to assemble edgebanding for a perfectly flush fit is to firmly clamp the solid wood piece down to a flat surface. Then slide the ply material into position and drive a fine thread self-tapping screw. Make sure that you test the amount of screw travel in scrap pieces before final assembly.

Edgejoining, or assembling workpieces edge to edge such as for a solid wood tabletop is easily accomplished with pocket hole joinery. In traditional edgejoining, the workpieces are only glued together and then pipe clamped overnight to allow for the glue to set-up. With pocket hole joinery one simply glues and screws to assemble one layer at a time. This process can be immediately followed by sanding and trimming to size without delay.



## Standard Dimensions

Materials to be edgejoined are typically solid wood. The general rule of thumb is to not edgejoin a board that is wider than 5" to avoid any cupping or bowing that could occur with changes in moisture levels. It is recommended to alternate the growth rings of the individual boards being joined to head off any potential problems.



(Alternating grain direction)

## Steps to Edgejoin a Tabletop

### 1. Plane wood to same thickness. Rip to width and joint edges.

It is important to plane your wood to the same thickness to assure a flush top that requires minimal sanding. Once your boards are ripped to length, it is recommended to joint the edges of the board to create a tight joint line.

### 2. Drill pocket holes into edge of boards.

Layout your boards on a workbench. Alternate grain direction and choose the best face on each board. Layout pocket hole placement approximately every 6-8 inches across the length of the board with pencil lines (note you will not have to drill pocket holes into the first board in the sequence).

### 3. Clamp flush and drive screws.

On the first board, place a Face Clamp™ on the joint line directly over the pocket hole. Make sure that the large pad of the clamp is on the face side of the joint line to keep the workpieces perfectly flush. Assemble one screw at a time, moving the clamp directly over each pocket hole while assembling.

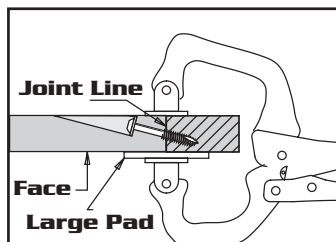

## Plugging a Pocket Hole

Normally pocket holes are placed on the backside or underside of a project where they are hidden from view. From time to time however, you may find the need to place one in a visible location. In this event, KREG manufactures solid wood pocket hole plugs that can be glued in over the head of the screw and sanded flush to conceal the hole. These plugs are available in a variety of wood species.

### Anatomy of a Pocket Hole Plug

Plugs are cut at an angle so that they sit perfectly flush on the top of the screw head when fully inserted. A small amount of plug will remain above flush and will need to be either trimmed off with a hand saw or sanded.

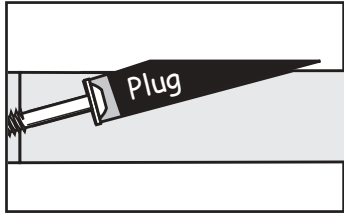

### Steps to Plug a Pocket Hole

#### 1. Drill hole to adequate depth and drive screw to secure joint.

One of the most frequently asked questions we receive is why does the plug not fully cover the pocket hole? Normally this is caused by not drilling the pocket hole deep enough to allow the plug to fully close the hole. Our normal suggestion is to set the depth collar on the drill bit approximately 1/8" further from the step of the drill bit to insure that the screw head will be deep enough into the pocket.

#### 2. Glue and press into place.

Place a fair amount of glue into the bottom of the pocket and then also around the perimeter of the plug itself. Press into place and wipe away excess glue. The Mini Kreg Jig® contains a recess on its' underside that can be used to firmly seat the plug into place.

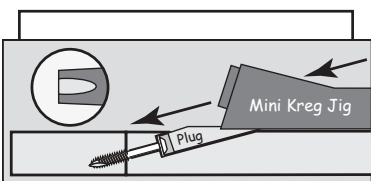

**Pressing a plug into place.**

#### 3. Trim or sand off excess plug.

Once the glue has setup, plugs can be trimmed or sanded off. Softwoods such as pine and basswood can often be made flush with an orbital sander while hardwoods such as oak and maple will most likely require trimming with a flush cut handsaw before final sanding. We have found that a laminate trimmer fitted with a bull-nose bit and a 45 degree base also works well if you will be trimming a number of plugs.

### **Why do I need to use a 2,000+ rpm drill to make the pocket holes? What brand do you recommend?**

A drill that is rated at 2,000 RPM or above is considered a woodworking drill. RPM's below that are normally seen in metal-working drills. The higher the RPM, the cleaner the hole and the longer the drill bit lasts. A 1,500 RPM drill will do the trick, but you will see slightly more wear on the bit over time. Most of the major tool manufacturers produce a drill above 2,000 RPM.

### **Do I need to drill all the way through the edge of the workpiece?**

No. We recommend setting the depth collar so that the tip of your drill bit rests approximately 1/8" from the base of the jig for 3/4" material. Why you ask? By not drilling all the way through the edge you won't have to deal with the possibility of having a burr that you will need to remove before joining your pieces. The self-tapping tip of the pocket hole screw will easily drill through the last 1/8" of an inch and drill its own hole into the second workpiece, drawing the pieces tight without having to pre-drill.

### **Do I need to drill a pilot hole into the second workpiece?**

No. The self-tapping tip of the pocket hole screw accomplishes this task for you. Even in very hard woods like hickory and maple no pre-drilling is required which saves an immense amount of assembly time.

### **Can I use pocket holes in melamine and MDF?**

Yes. They are usually a little more finicky than simple hardwoods so here are a few suggestions that we find helpful...

1. Make sure you're using a sharp drill bit.
2. SLOW DOWN! Use a slower feed rate while both drilling the pocket hole and driving the screws.
3. Set the clutch setting on your driver to a light setting to avoid overdriving the screw.
4. Use a coarse thread, self-tapping screw with a washer head for maximum holding power.
5. Try to place pocket holes at least an inch from the end of your workpiece. (The workpiece may split if the screw is driven too close to the edge)

**What is the recommended pocket hole spacing across a panel?**

We suggest that you place pocket holes every 6-8 inches across the length of a workpiece for adequate strength. Feel free to place them closer or further apart as the application warrants.

**I am experiencing wood movement as I screw my joint together. How can I eliminate this?**

First and foremost, the use of our Face Clamps will eliminate most wood movement while driving a screw. A good rule to use whenever attempting to assemble a pocket hole joint is that the screw will tend to pull the workpieces away from the side the pocket hole is placed on. Therefore, a simple solution is to always clamp a stop (clamp, scrap workpiece, workbench) on the opposite side of the pocket holes. By doing this, you will be able to consistently produce perfectly flush joints.

Another trick that seems to work well if you're experiencing movement mainly caused by the lubricity of glue on the joint line is to first dry fit your workpieces and drive one or two screws, then disassemble, apply glue to the workpieces and re-assemble.

**I am afraid to use pocket holes because I am worried about wood expanding and contracting with changes in the seasons. What do you recommend?**

There are a couple of easy ways to compensate for this type of wood movement. Let's assume an example of attaching a rail or apron to a solid tabletop. First, set your depth collar on the drill bit so you barely drill through the edge of the rail or apron. This will create a larger pilot hole for the screw shank and will create the effect of a "floating top". Secondly, drive the screw into the top until tightened, then back off 1/4 of a turn. This will allow for plenty of expansion and contraction of the wood.



## **How strong is a pocket hole joint compared to a mortise and tenon joint?**

This is a question we get asked quite often. An independent lab completed testing a few years back that showed that a pocket hole joint failed at 707 pounds when subjected to a shear load while a mortise and tenon joint failed at 453 pounds (approximately 56% stronger). Pocket hole joints are tremendously strong for a couple of reasons. **1)** The use of a mechanical fastener (screw) is significantly stronger than the material around it (wood), and **2)** The amount of direct clamping force placed on the joint by driving the screw combined with today's glue technology makes for a sensationally strong bond. A second question we get asked from time to time is in what applications are pocket hole joints appropriate. This is commonly asked when the project being built is a swing set, deck, or bunk beds. Although pocket hole joints are exceptionally strong, the rule of thumb is to ***never use a pocket hole joint in place of a structural bolt, hanger or fastening device.***

## **The pocket hole plugs sit well over flush when placed in the bottom of the pocket hole. Is this normal? What is the best way to sand plugs flush?**

Yes, this is normal. The depth that the plug seats into the bottom of the hole depends on the depth of the hole that is drilled. We must make the plugs with a certain tolerance of plug length to allow for varying hole depths. As a general rule, the deeper you drill the hole, the less plug you will need to sand off. There are a couple of different ways to trim plugs. If you will be trimming very few plugs, a flush cut hand saw followed by a light sanding works very well. If you will be trimming many plugs we recommend using a laminate trimmer outfitted with a bull nose bit. Trim off the majority of the plug, and then finish with a light sanding. See page 30 for more details.

## **The pocket hole plugs are too large for the hole, what can I do to make them fit?**

As odd as it may sound, a good way to shrink plugs is to place them in the microwave for a few seconds. This normally removes enough moisture to allow easy installation.

## **Should I use glue with pocket hole joinery?**

Glue is not required for pocket hole joinery, but we normally recommend using glue if you never foresee a need to take your project apart. With pocket hole joinery, you only need a thin coat of glue to get an extremely strong bond because of the immense amount of clamping pressure applied on the joint line by the self-tapping screws. Glue squeeze-out as a result, should be minimized.

**How can I get the longest life out of my drill bit?**

We suggest following a few simple guidelines to get the longest life out of your drill bit.

- 1. Use a corded drill rated at 2,000 rpm or above (this is normally characterized as a woodworking drill, a metal-working drill is usually rated under 1,500 rpm).
- 2. Place the bit into the drill guide before starting the drill.
- 3. Make sure the drill is up to full rpm before plunging it into the workpiece. Sharpen the bit before it becomes so dull it breaks. In oak, this averages about every 2,500 pocket hole.

**How many holes can I expect to drill before sharpening my drill bit?**

You can expect to drill between 2,000 and 3,000 holes with your KJD drill bit when working with oak material. Drill bit life directly correlates to material composition.

**Can the Kreg drill bit be sharpened?**

Yes, we have a factory sharpening service for KREG bits only. KREG drill bits have "Kreg" stamped into the shank of the bit. We recommend sharpening the Kreg Jig® KJD bit every 2,500 holes and the DKDB (machine) bit every 8,000 holes. Package the bit securely and send it along with a check to the address at the bottom of the page.

Sharpening rates are as follows...

***In the continental U.S.A. –***

\$4.00 for the 1st bit and \$2.00 for each additional bit

***In Canada, Hawaii, Alaska and Puerto Rico –***

\$6.00 for the 1st bit and \$2.00 for each additional bit



***Kreg Tool Co.  
 201 Campus Drive  
 Huxley, IA 50124  
 Attn: Drill Sharpening***

### **What type of warranty do the pocket hole jigs carry?**

We are confident that you will enjoy your KREG products. The Mini Kreg Jig®, Rocket™ Jig and K2000 Kreg Jig® all carry a lifetime warranty on their hardened steel drill guides when used with the KREG KJD drill bit. All of our tools also carry a 30-day complete satisfaction guarantee. If for any reason you are not completely satisfied within 30 days of purchase return the product along with your proof of purchase to the location you purchased the product from.

### **Are drill bits covered with a warranty?**

No. Drill bits are not covered with any type of warranty. We are extremely confident that with due care our drill bits will exceed your expectations. If you are dissatisfied with the performance of your bit (ie. the bit broke on the 5th drilled pocket hole) please review the guidelines for extending drill bit life and contact us if you still have a concern and we will do our best to accommodate you.

### **Contact Information**

Feel free to contact us with any questions, comments, concerns, or product suggestions. Send via email [customerservice@kregtool.com](mailto:customerservice@kregtool.com) or mail to...

*Kreg Tool Company  
201 Campus Drive  
Huxley, IA 50124*

*800-447-8638  
515-597-2234  
(fax) 515-597-2354*

*website: [www.kregtool.com](http://www.kregtool.com)  
email: [customerservice@kregtool.com](mailto:customerservice@kregtool.com)*



**POCKET HOLE SYSTEMS™**

*Kreg Tool Company  
201 Campus Drive  
Huxley, IA 50124*

*Phone: 515-597-2234  
Toll Free: 800-447-8638  
Fax: 515-597-2234  
[www.kregtool.com](http://www.kregtool.com)*