



ZIPPITY

Easy Does It!

HUNTERSVILLE VINYL SCREEN 2-PACK (36" W X 45" H)

60 MIN

Approximate assembly time for 2 screens

If necessary, this screen can be trimmed down vertically to fit your custom space. Use a fine-toothed circular or hack saw. Rails will need to be re-spaced and configured accordingly.

Want to see a video on how to assemble this product?
Scan the QR code



ASSEMBLY INSTRUCTIONS ZP19036

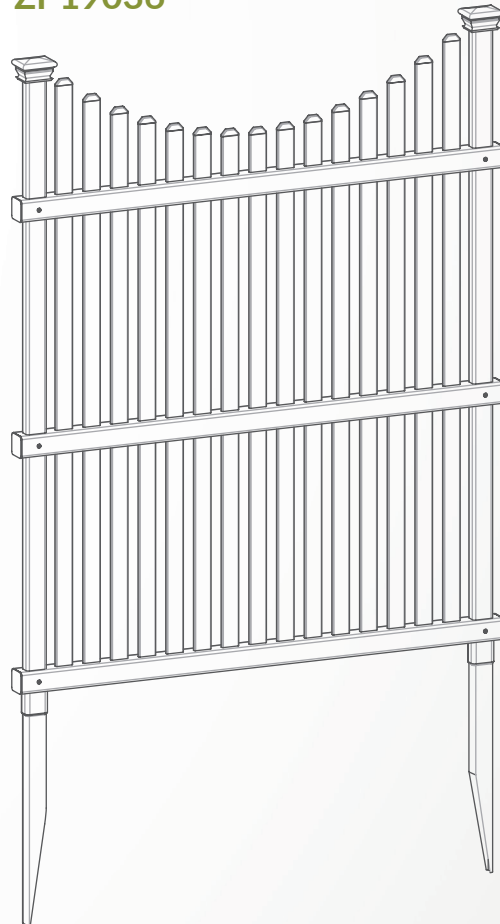

GENERAL INFORMATION



IMPORTANT

- + Check the inside of the larger pieces in your box for other materials packed inside.
- + When assembling components, place on a non-abrasive surface (i.e. shipping box) to avoid scratching.
- + We recommend an area approximately 5'x 8' for unobstructed assembling.
- + You should not need to use excessive force when assembling components.

MISSING OR DAMAGED PARTS?

VISIT OUR WEBSITE FIRST, SO WE CAN HELP YOU RIGHT AWAY!

Although great care has been taken to ensure proper packaging and handling of this product, occasionally problems occur. If you discover any missing, damaged or defective parts, please visit our website to order replacement parts. If you experience any further trouble with your product, please contact our customer service department.

 parts.nychbrands.com

 support@zippity-outdoor.com

 **704-892-5222 / 877-234-6196**

Customer service agents are available to take calls weekdays from 8am-5pm EST. If you call outside of business hours, please leave a voicemail.

To help you quickly and accurately, please have reference item number **ZP19036** and the specific part name which can be found on page 4. It is helpful if you can provide the batch lot which is a stamped number on the end of the box.

NEED ASSEMBLY HELP?

If you are having problems with the assembly or installation of this product, we are happy to assist you with the process, **so please give us a call at 704-892-5222 / 877-234-6196.**

NEED TO RETURN?

If for some reason you need to return this product, please allow us to help resolve your issues first. If you still decide to return the product, **you will need to initiate the return from the company you originally purchased from.**

Detailed Product Dimensions & Specifications

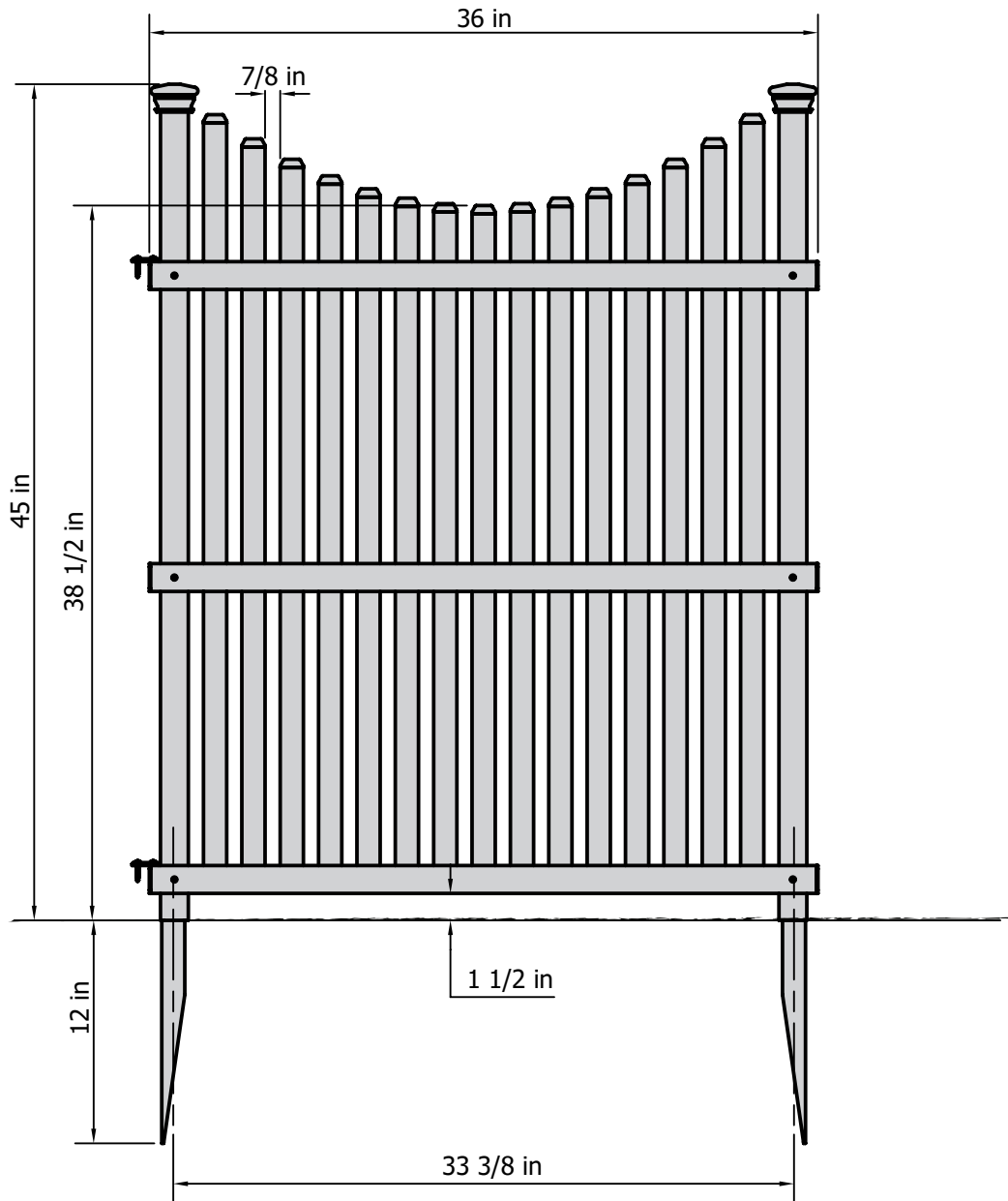

STEP 1: LAY OUT MATERIALS

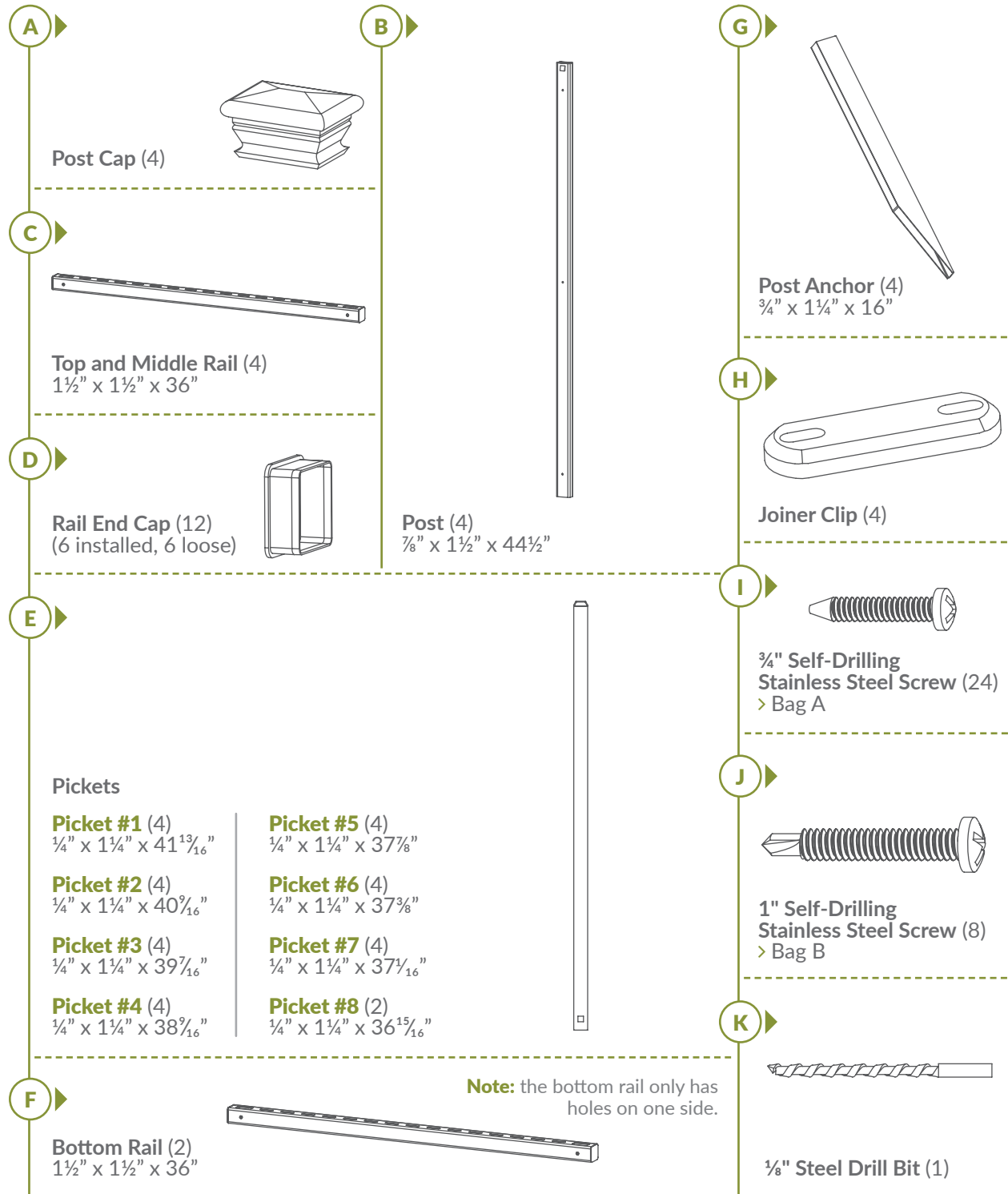

STEP 2: ASSEMBLE SCREEN FRAME

STEP 2.1

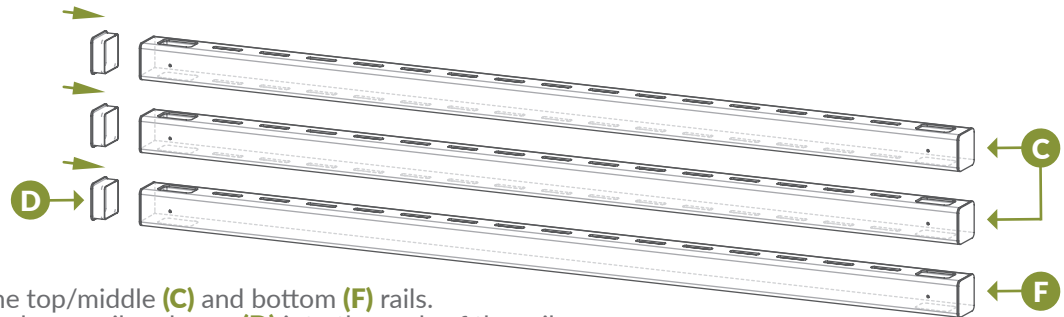

► Identify the top/middle (C) and bottom (F) rails.
Fit the three loose rail end caps (D) into the ends of the rails.

STEP 2.2

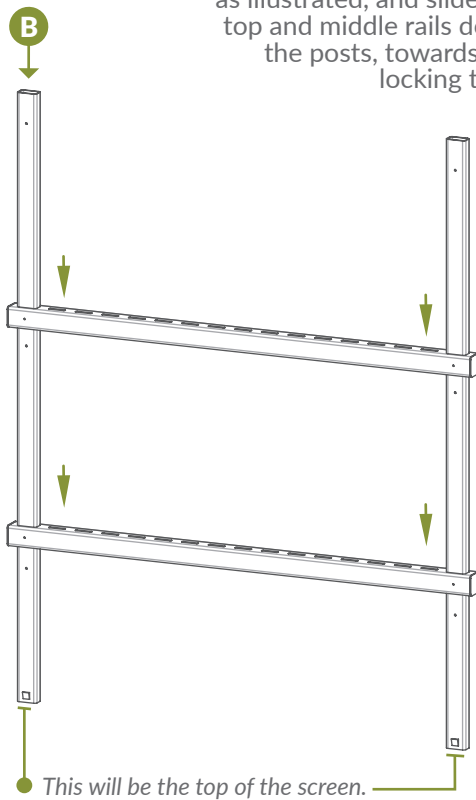

► Position the two posts (B) as illustrated, and slide the top and middle rails down the posts, towards the locking tabs.

● This will be the top of the screen.

Tip: shine a flashlight down the end of the posts to help identify alignment of pre-drilled holes.

STEP 2.3

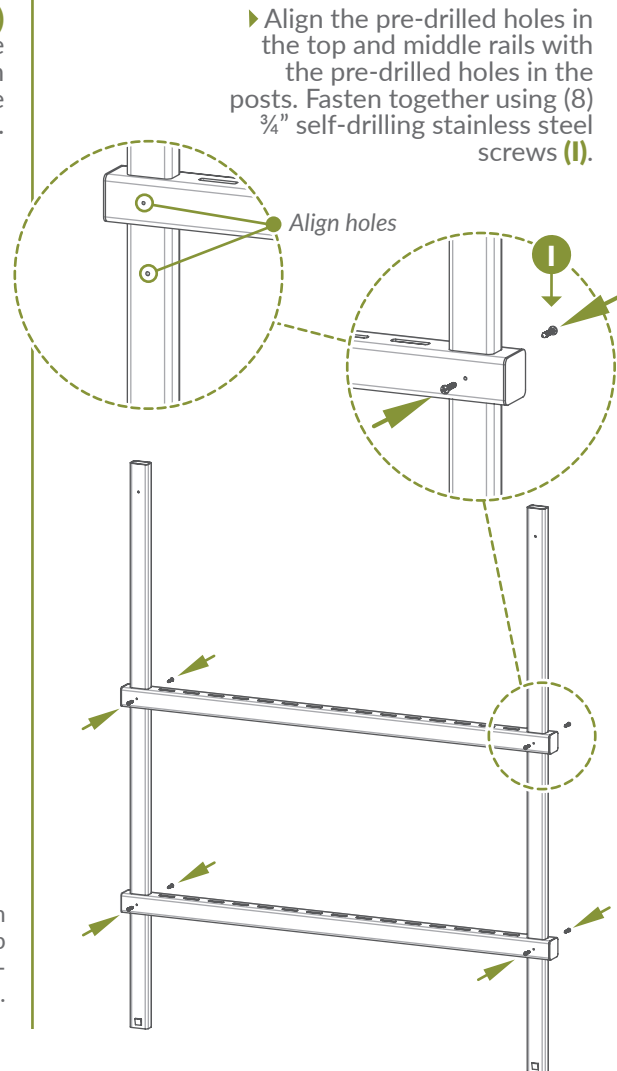

► Align the pre-drilled holes in the top and middle rails with the pre-drilled holes in the posts. Fasten together using (8) 3/4" self-drilling stainless steel screws (I).

Align holes

STEP 3: ASSEMBLE FENCE PANEL

STEP 3.1 ▶

1. Slide the bottom rail over the post, aligning the pre-drilled holes on the bottom rail with the holes on the post.
2. Insert the Post Anchors (G) 6" into the bottom of the post. 10" of post anchor should be visible.
3. Use the 1/8" drill bit (K) to drill (4) total holes in the post anchor through the pre-drilled holes in the bottom rail.
4. Drive (4) 3/4" self-drilling stainless steel screws into the pre-drilled holes in the bottom rail.

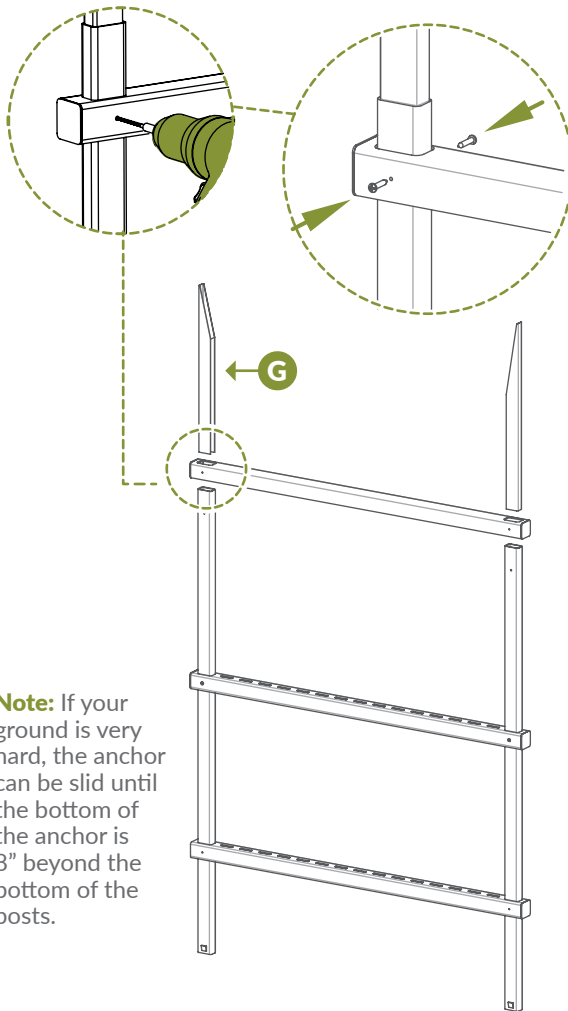

Note: If your ground is very hard, the anchor can be slid until the bottom of the anchor is 8" beyond the bottom of the posts.

STEP 3.2 ▶

- ▶ One by one, guide the numbered pickets (E) through the top and middle rails until the pickets lock into place in the bottom rail.

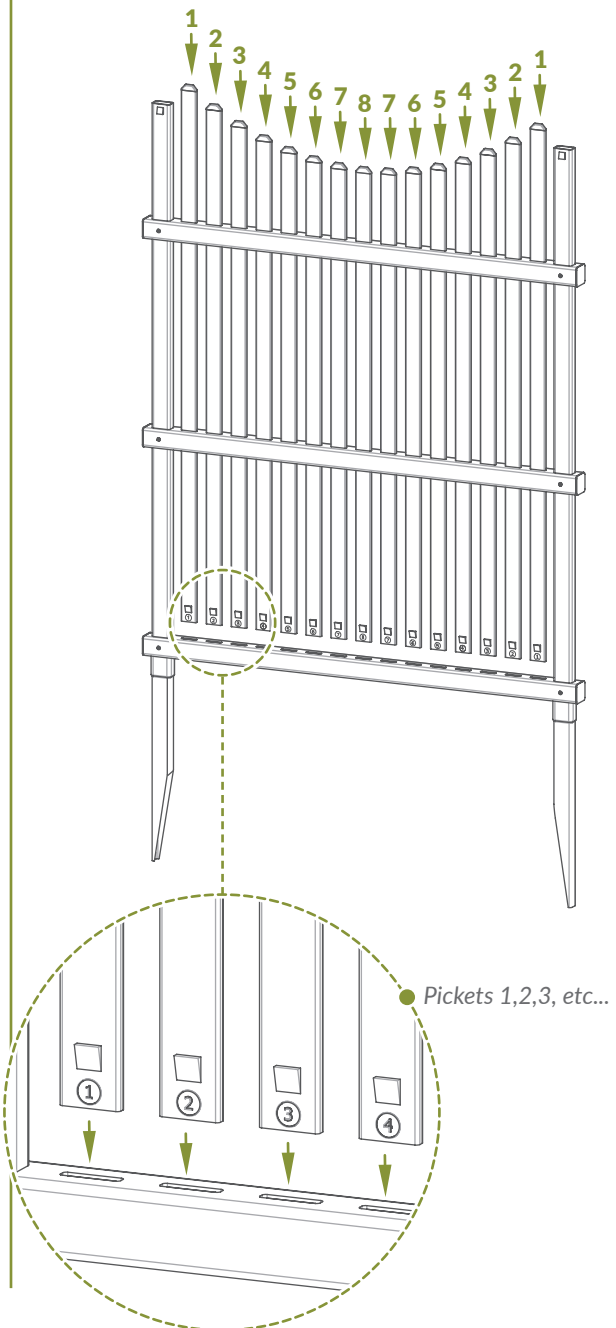

STEP 3.3 ▶

- ▶ Repeat steps 1 through 3 for your second screen.

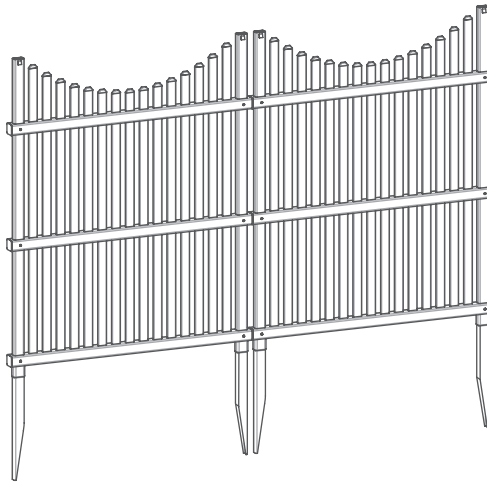
**STEP 4: INSTALL SCREEN INTO GROUND****STEP 4.1** ▶

- ▶ Move the screen to its final location, and identify the location of the posts.

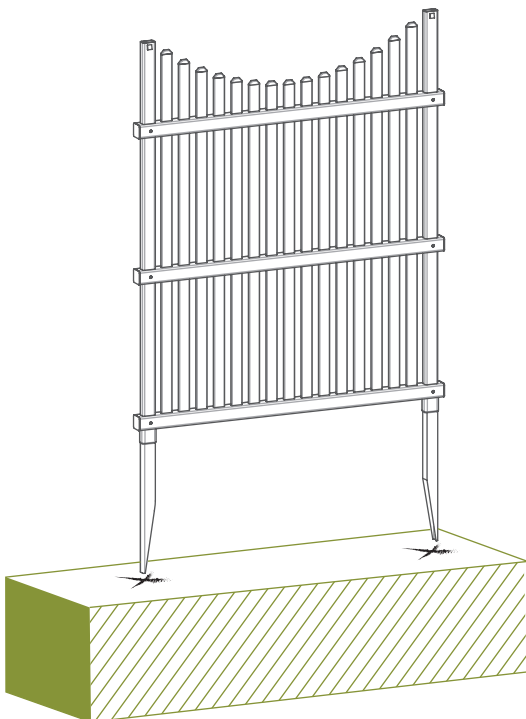
**STEP 4.2** ▶

- ▶ Attempt to push the unit into the ground as illustrated. All 10" of the post anchors should be inserted into the ground, so that they are no longer visible.

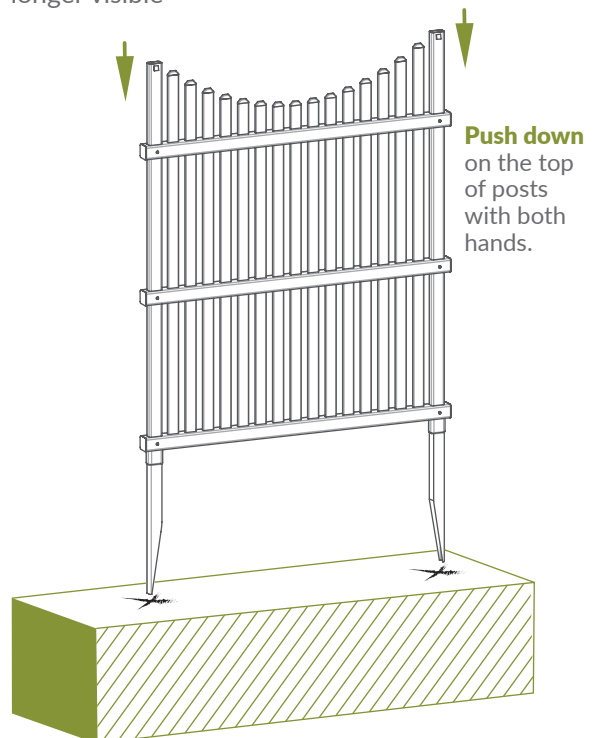

STEP 4.3 ▶

▶ **Step 4.3 is only to be completed if the ground is too hard:**

1. Loosen the top 6" or 7" of the ground with a claw hammer as illustrated.
2. Add water to loosen soil.
3. Use a block of wood to protect the top of the post, and gently hammer the post into the ground.

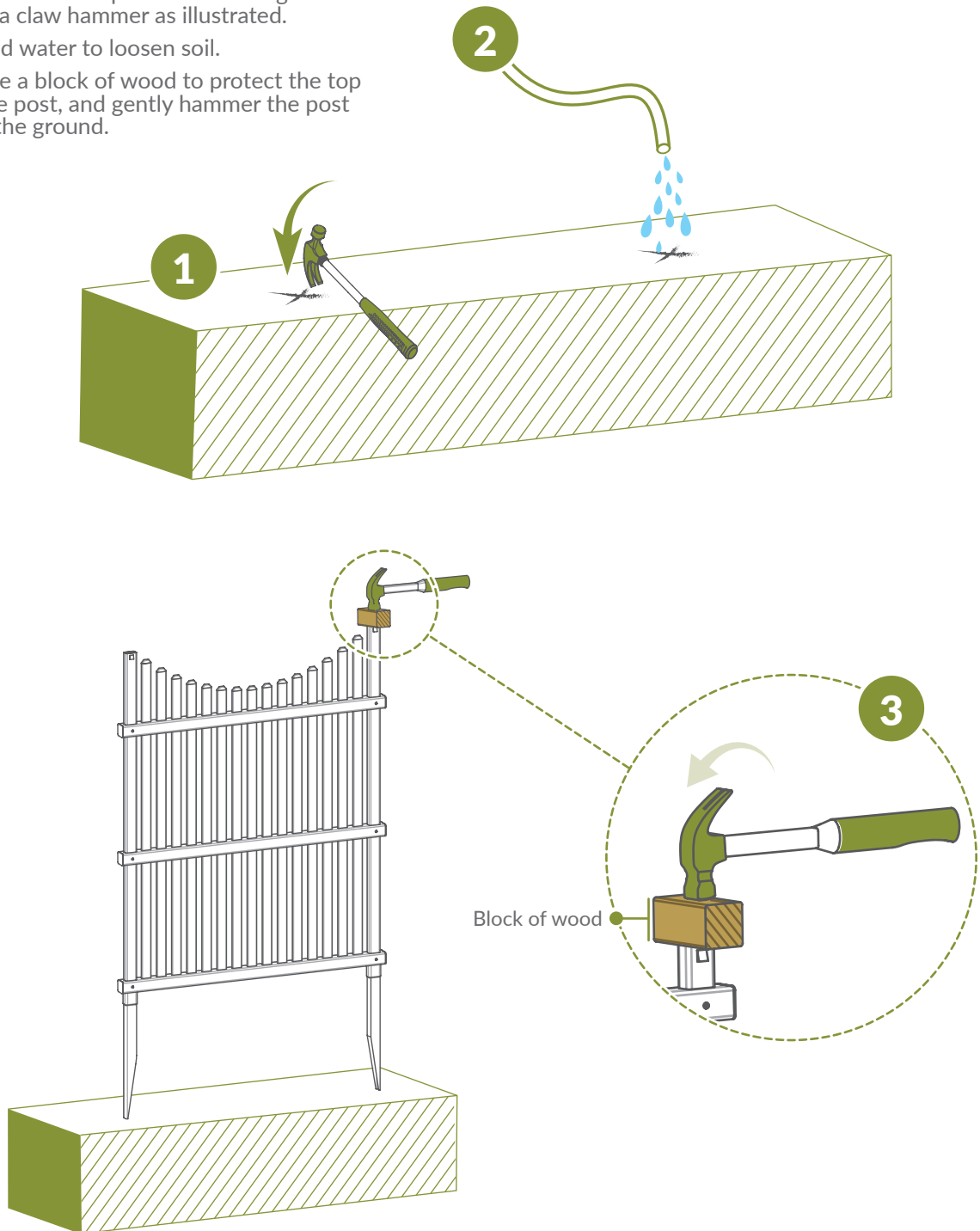

STEP 4.4 ▶

▶ Level the screen as necessary, then backfill and compact the excavated dirt.

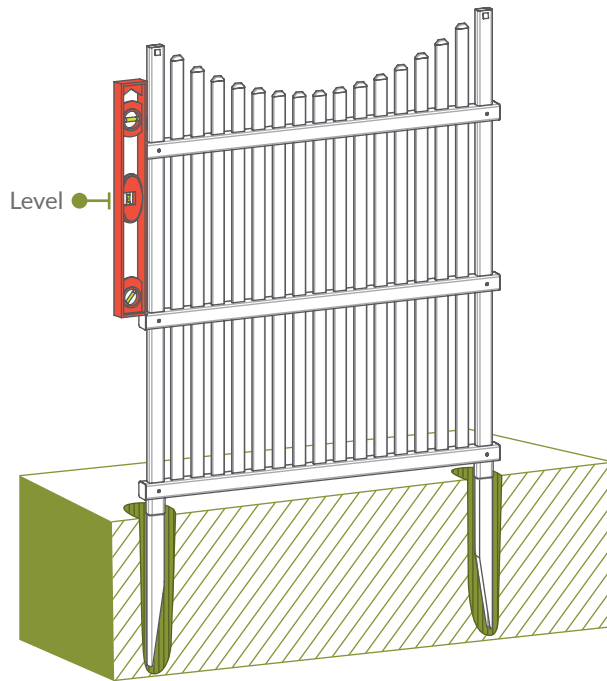
**STEP 4.5** ▶

▶ If your ground is really hard, you may need to dig a hole large enough to accommodate one post from each screen into the same hole. Backfill and compact dirt.

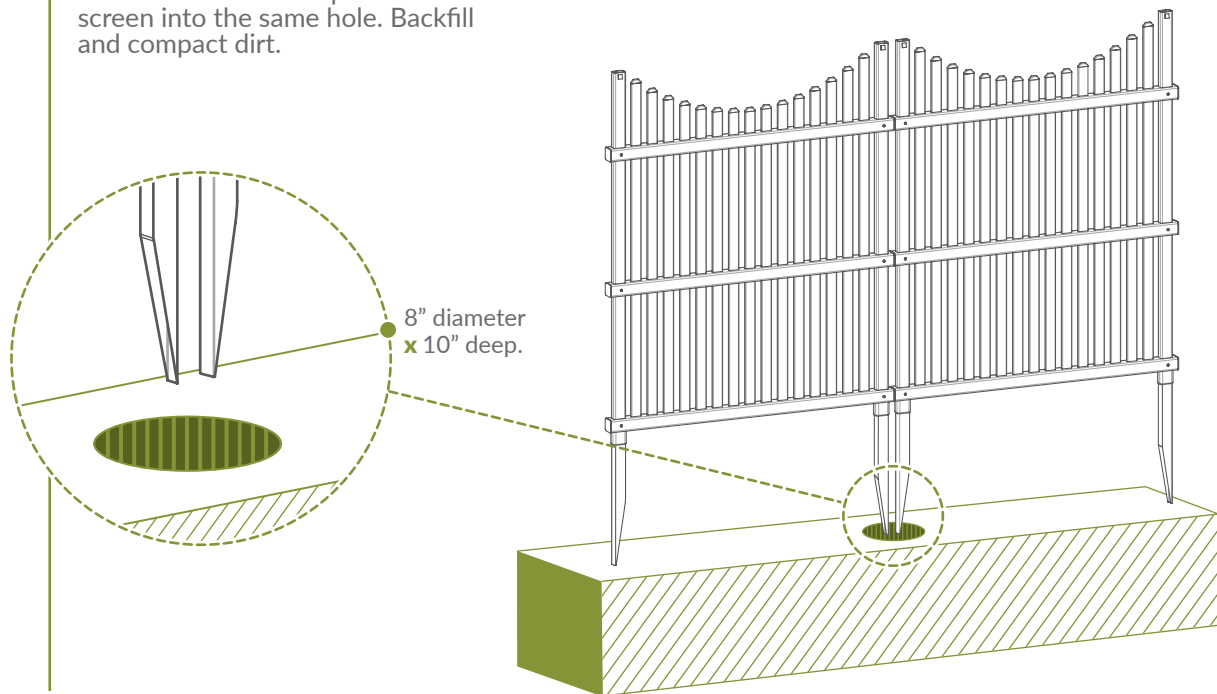

STEP 5: FASTEN JOINER CLIPS

STEP 5.1

▶ Fasten screens together by using (2) joiner clips (H) and (4) 1" self-drilling stainless steel screws (J) as illustrated.

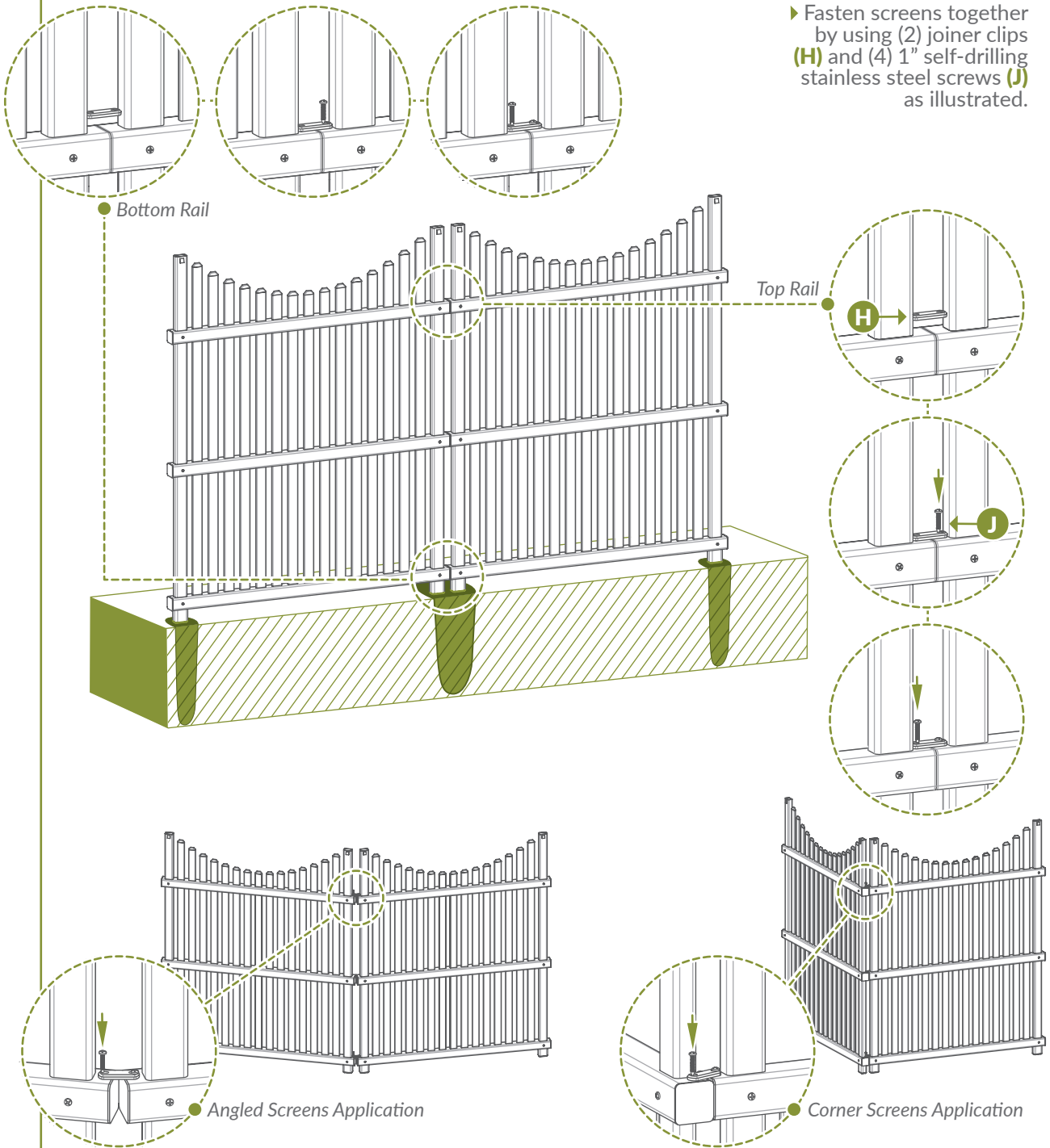

STEP 6: FASTEN POST CAPS

STEP 6.1 ▶

▶ Push the post caps (A) down over the posts to lock into place.

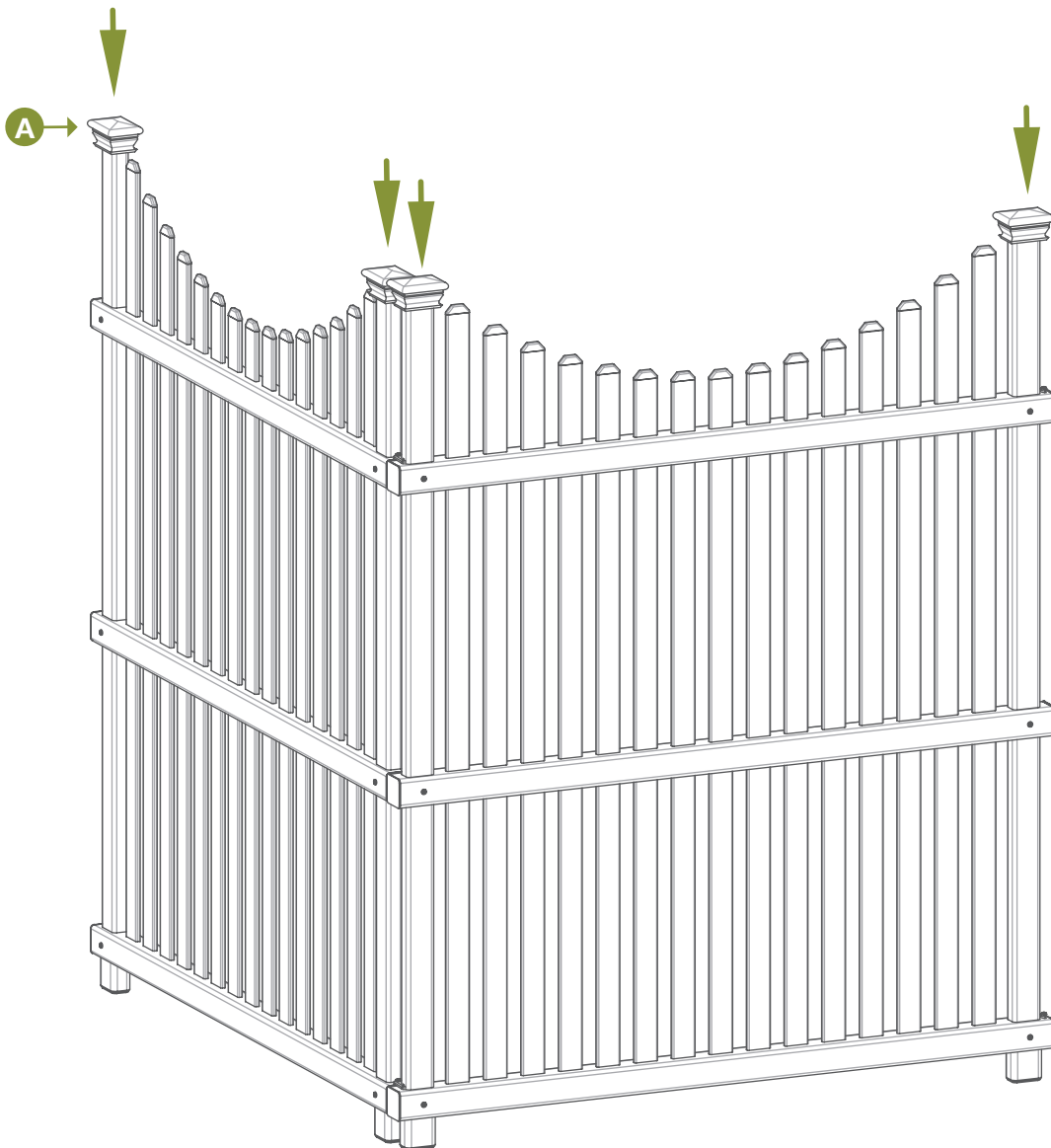



ZIPPITY

Easy Does It!



6935 Reames Rd. Ste. K.
Charlotte, NC 28216



support@zippity-outdoor.com

704-892-5222
877-234-6196



WWW.ZIPPITY-OUTDOOR.COM