

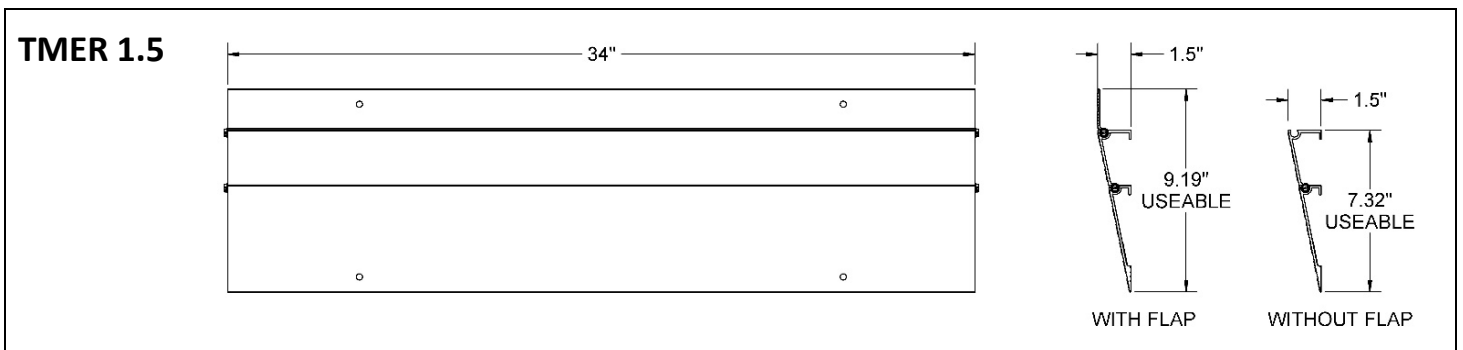

TRANSITIONS® Modular Entry Ramp Technical Specifications

MODEL	TMER 1	TMER 1.5	TMER 2	TMER 3	TMER 4	TMER 5	TMER 6
HEIGHT & USAGE GUIDELINES (RISE)	.75" – 1.25"	1.25" – 1.75"	1.75" – 2.25"	2.75" – 3.25"	3.75" – 4.25"	4.75" – 5.25"	5.75" – 6.25"
USABLE SIZE (L x W)	W/FLAP 6.67" x 34"	W/FLAP 9.19" x 34"	W/FLAP 11.67" x 34"	W/FLAP 16.64" x 34"	W/FLAP 21.64" x 34"	W/FLAP 26.64" x 34"	W/FLAP 31.64" x 34"
	W/O FLAP 4.82" x 34"	W/O FLAP 7.32" x 34"	W/O FLAP 9.80" x 34"	W/O FLAP 14.77" x 34"	W/O FLAP 19.77" x 34"	W/O FLAP 24.77" x 34"	W/O FLAP 29.77" x 34"
FLAP DIMS (L x W)	1.79" x 34"	1.79" x 34"	1.79" x 34"	1.79" x 34"	1.79" x 34"	1.79" x 34"	1.79" x 34"
WEIGHT	3 lbs.	5 lbs.	5.5 lbs.	8 lbs.	11 lbs.	15 lbs.	20 lbs.
WEIGHT CAPACITY (DO NOT EXCEED)	700 lbs.	700 lbs.	700 lbs.	700 lbs.	700 lbs.	700 lbs.	700 lbs.
MADE OF ALUMINUM	✓	✓	✓	✓	✓	✓	✓
SLIP-RESISTANT SURFACE	✓	✓	✓	✓	✓	✓	✓
FOR WHEELCHAIRS & SCOOTERS	✓	✓	✓	✓	✓	✓	✓
WARRANTY	Lifetime Limited	Lifetime Limited	Lifetime Limited	Lifetime Limited	Lifetime Limited	Lifetime Limited	Lifetime Limited
COUNTRY OF ORIGIN	USA	USA	USA	USA	USA	USA	USA

- Weights and dimensions are approximate and subject to change.
- If using with mobility equipment, refer to your mobility equipment's owner guide for acceptable usage, including proper slope/incline, chair direction, etc.; never exceed its recommendations.

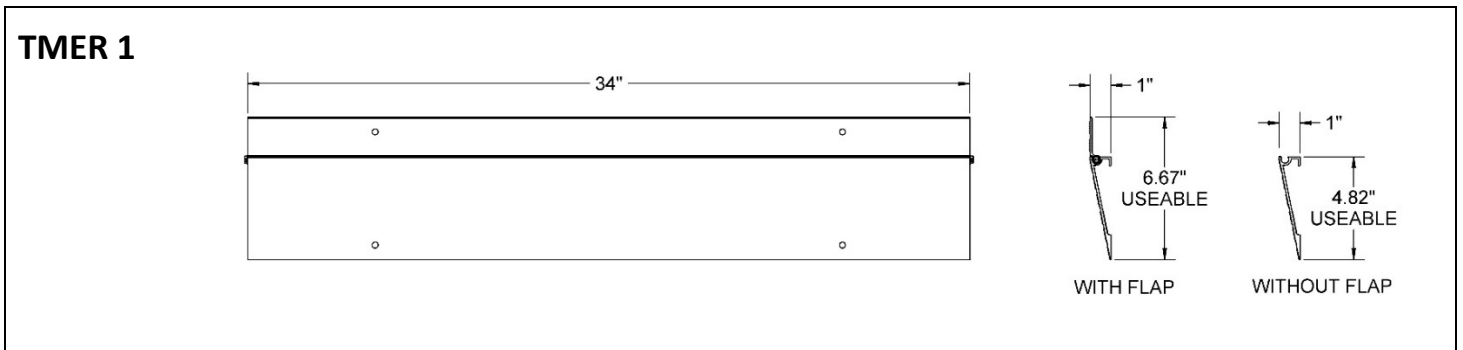



TRANSITIONS® Modular Entry Ramp Technical Specifications

TMER 2

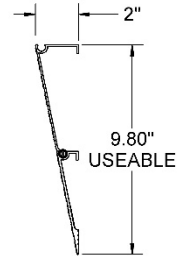
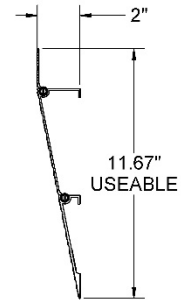
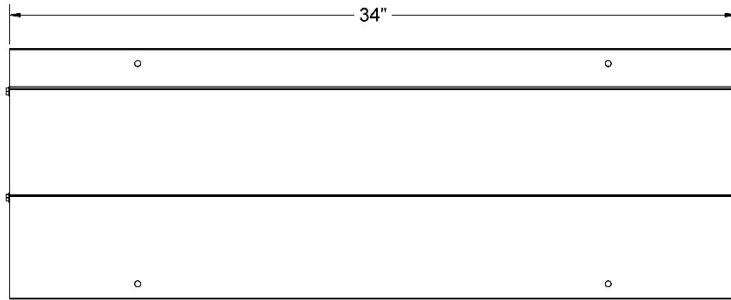

WITH FLAP

WITHOUT FLAP

TMER 3

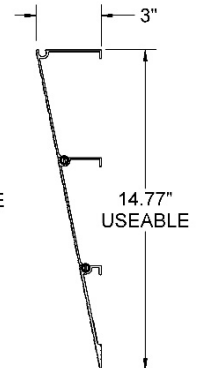
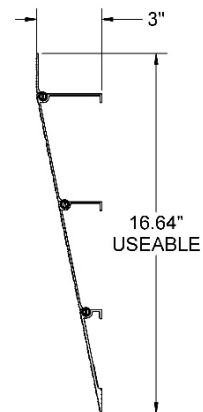
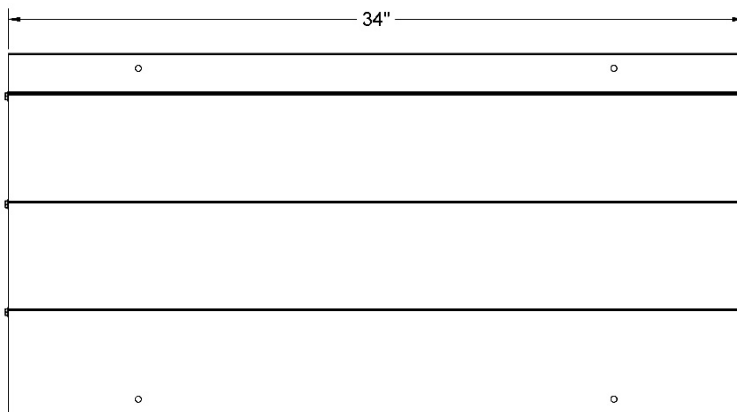

WITH FLAP

WITHOUT FLAP

TMER 4

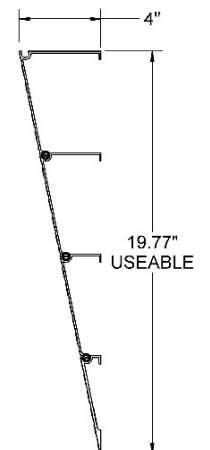
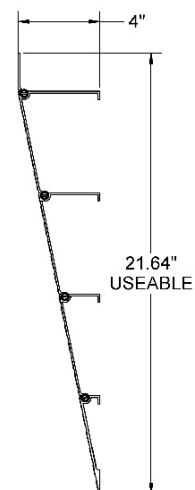
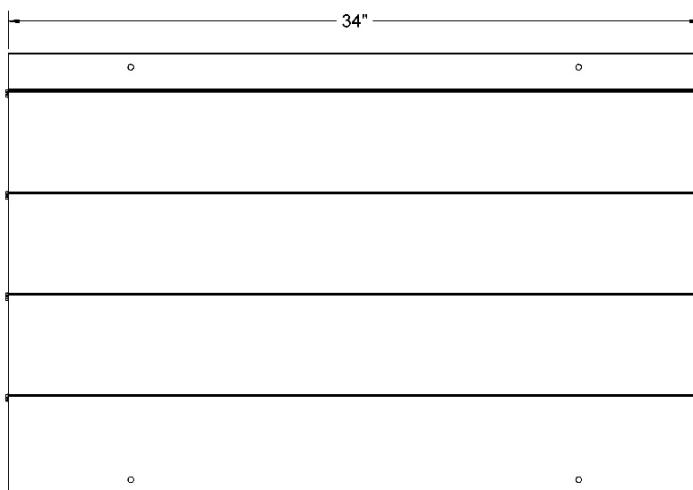

WITH FLAP

WITHOUT FLAP



TRANSITIONS® Modular Entry Ramp Technical Specifications

TMER 5

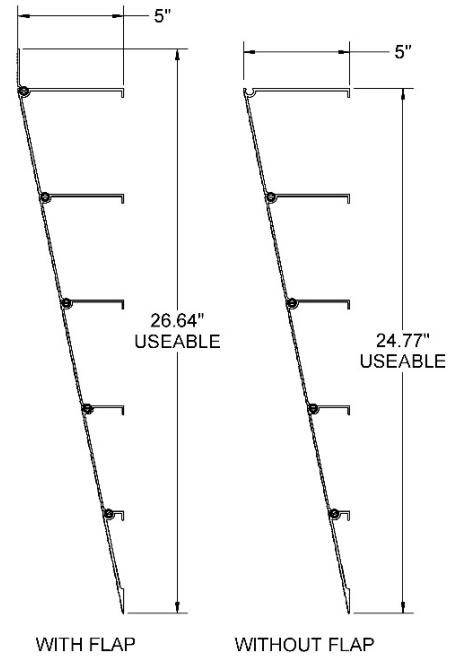
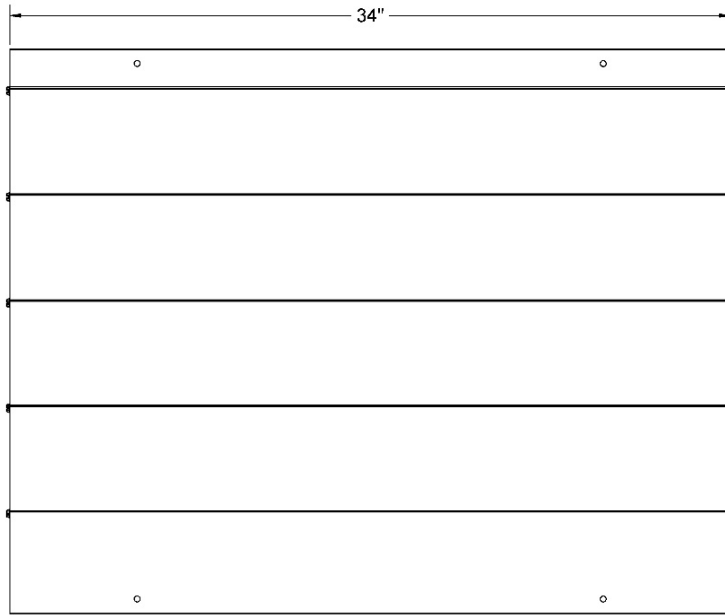

TMER 6

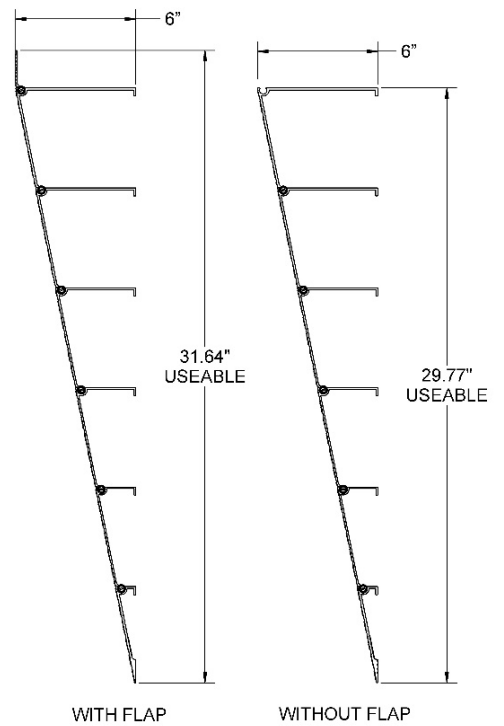
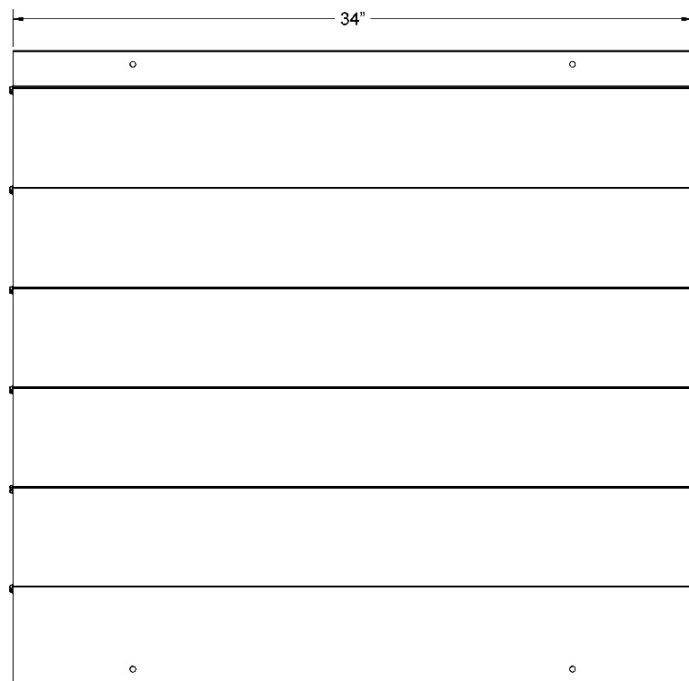



TRANSITIONS® Modular Entry Ramp Technical Specifications

TYPICAL ANCHOR PATTERN

