

Features

- 21-inch minimum base cabinet width (top-mount applications).
- 24-inch minimum base cabinet width (under-mount applications).
- Acid-resistant enamel finish.
- Single bowl.
- Top-mount or under-mount.
- 20-7/8" (530 mm) x 20-7/8" (530 mm) (top-mount)

Material

- KOHLER® enameled cast iron.

Recommended Accessories

- K-6539 Drainboard with Sink Rack
- K-6377 Sponge Caddy
- K-6378 Kitchen Brush Caddy
- K-6379 Kitchen Squeegee
- K-6382 Disinfecting Wipes Dispenser
- K-6383 Soap Dispenser
- K-8618 Paper Towel Holder
- K-8619 Flexible Kitchen Mat
- K-8624 Dish Scraper
- K-3192 Sink Rack
- K-5184 Sink Rack

Optional Accessories

- K-8801 Sink Strainer

Components

Product includes:

- 52047 Clamp Accessory Pack, 4 Ea.



Codes/Standards















ASME A112.19.1/CSA B45.2

KOHLER® Enameled Cast Iron Kitchen Sink Lifetime Limited Warranty

See website for detailed warranty information.

Available Color/Finishes

Color tiles intended for reference only.

Color	Code	Description
	0	White
	FF	Sea Salt™
	96	Biscuit
	47	Almond
	FD	Cane Sugar™
	NY	Dune
	95	Ice™ Grey
	G9	Sandbar
	K4	Cashmere
	FT	Basalt
	58	Thunder™ Grey
	20	Suede
	KA	Black 'n Tan
	FP	Caviar
	7	Black Black™

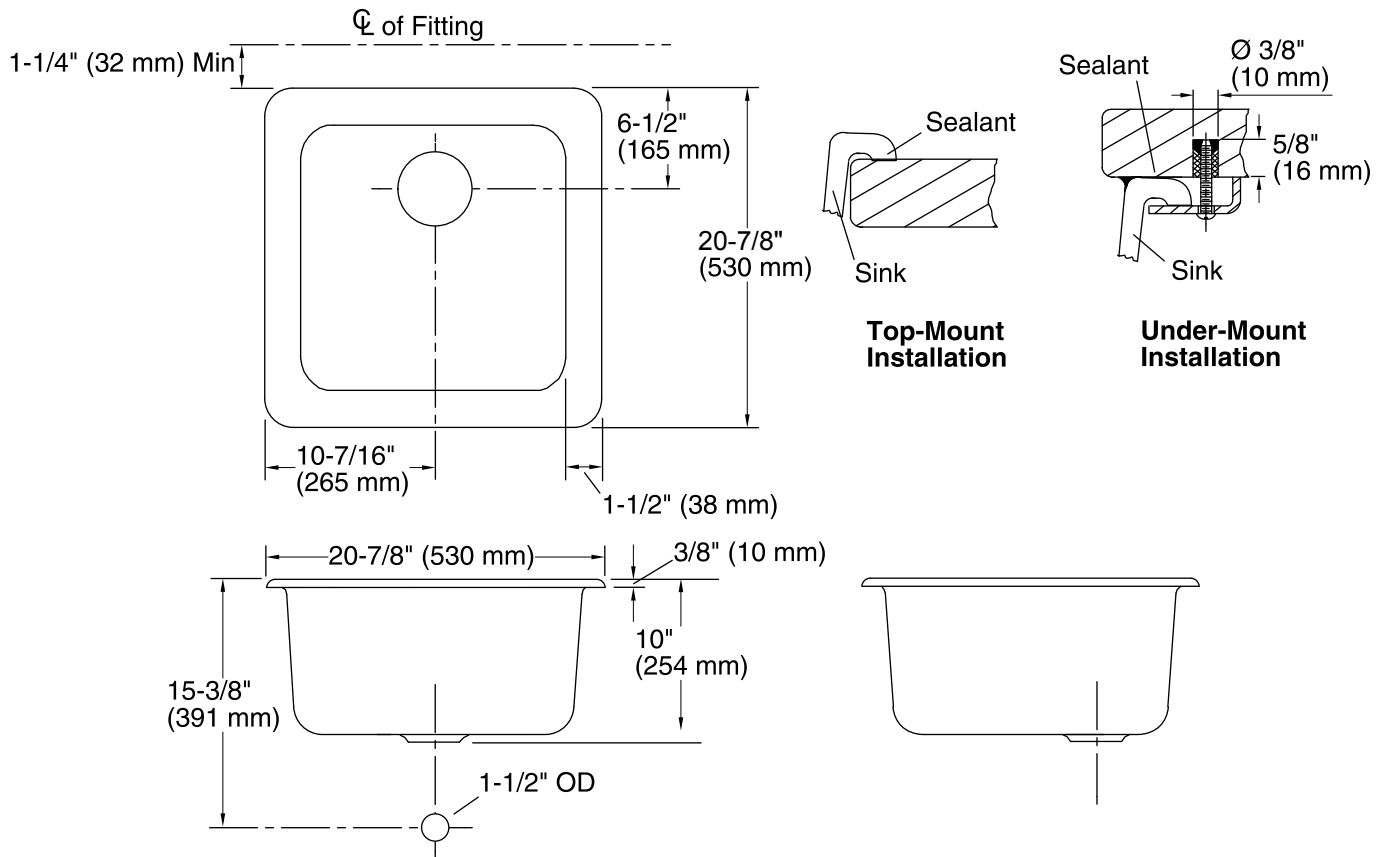

Technical Information

All product dimensions are nominal.

Bowl configuration:	Single
Installation:	Top-mount, Under-mount
Bowl area:	Length: 18" (457 mm) Width: 18" (457 mm) Bowl depth: 9-1/2" (241 mm)
Drain hole:	3-7/8" (98 mm)
Template:	114335-7, required, included

Notes

Install this product according to the installation instructions.

Supplied bowl clamp assemblies require 1" (25 mm) minimum countertop thickness. Installer must supply hardware for thinner countertops.

For multiple bowl under-mount installations, a minimum distance of 3-3/8" (86 mm) is required between bowls. Countertop supplier to determine required support.