



# Power Washer Parts Manual

## Model 006855-0

### **NOTICE!**

The information in this manual is known to be accurate as of the date of release shown on the cover. However, engineering changes can occur without notice. To obtain the proper parts, please be sure to use the serial number of the unit being serviced when ordering from this manual. Always refer to any parts notes and changes before ordering. All other parts not shown in this manual can be found on Generac's exploded view drawings online on GENservice at [www.generac.com](http://www.generac.com).

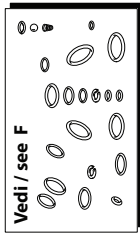
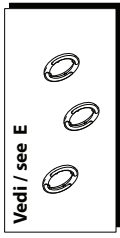

"D" VERSION

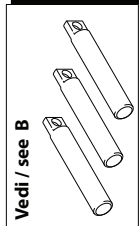
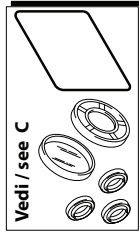
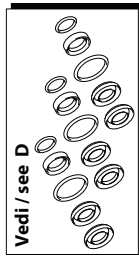
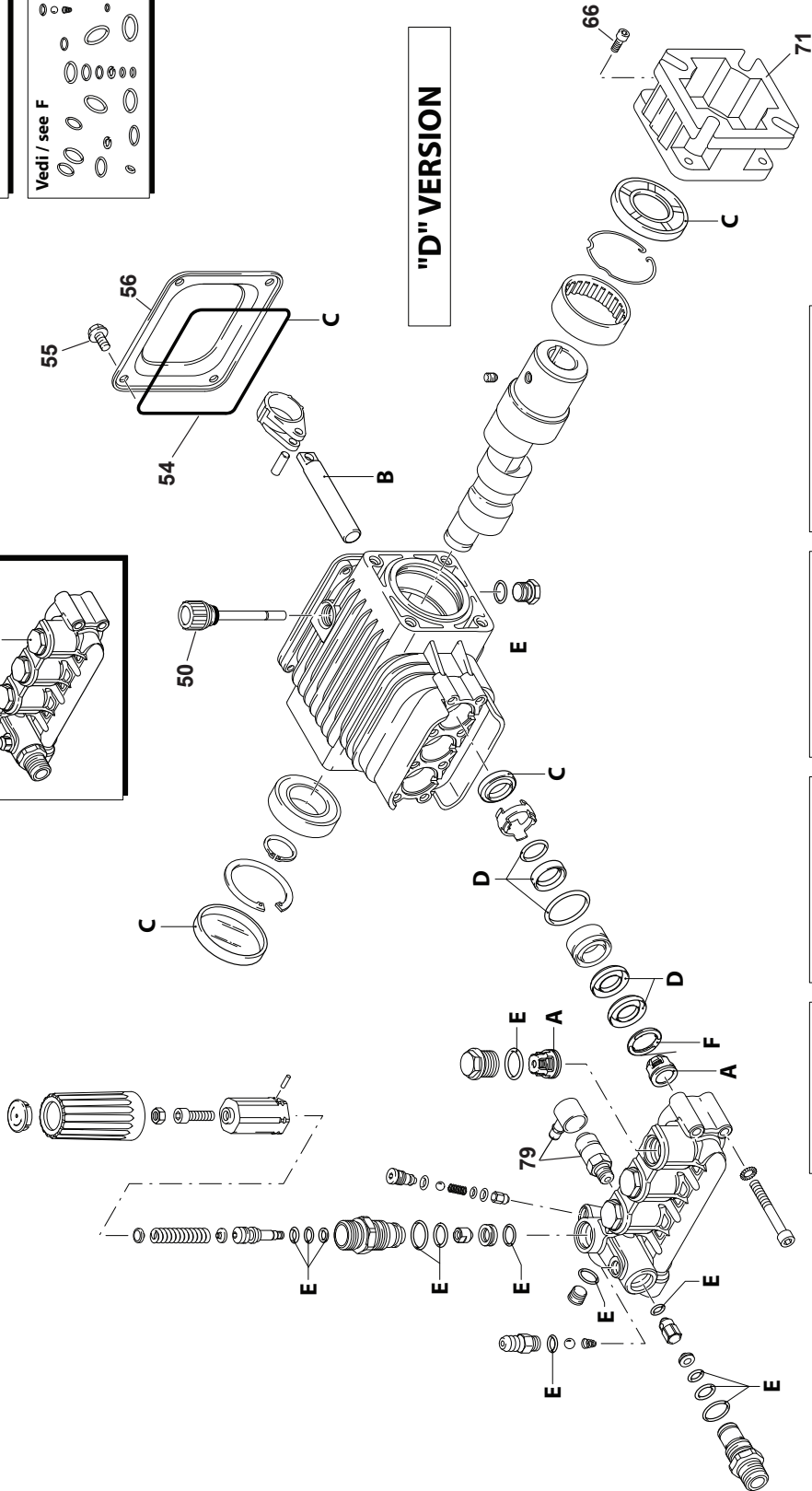
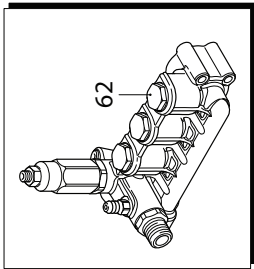

TYPE F25

# Power Washer Model 006855-0



ITEM	PART NO.	QTY.	DESCRIPTION
50	0H95660120	1	OIL CAP
54	0H95660121	1	GASKET
55	0H95660122	4	SCREW
56	0H95660123	1	REAR COVER
62	0K990201010	1	PUMP HEAD ASSEMBLY
66	0H95660125	4	SCREW
71	0J01720110	1	GAS ENGINE FLANGE
79	0H9570	1	THERMIC VALVE
<b>KIT NUMBERS</b>			
KIT A	0J04800118	1	VALVES
KIT B	0H95660111	1	PISTONS
KIT C	0k99020111	1	OIL SEALS
KIT D	0H95660113	1	WATER SEALS
KIT E	0H95660114	1	O-RINGS
KIT F	0H95660115	1	SUPPORT RINGS



# Power Washer Model 006855-0

©2015 Generac Power Systems, Inc. All rights reserved.  
Specifications are subject to change without notice  
No reproduction allowed in any form without prior written consent from Generac Power Systems, Inc.