

Item #1001220862

Model #NB33307

HAMPTON BAY[®]

USE AND CARE GUIDE

CADE 3-LIGHT VANITY FIXTURE

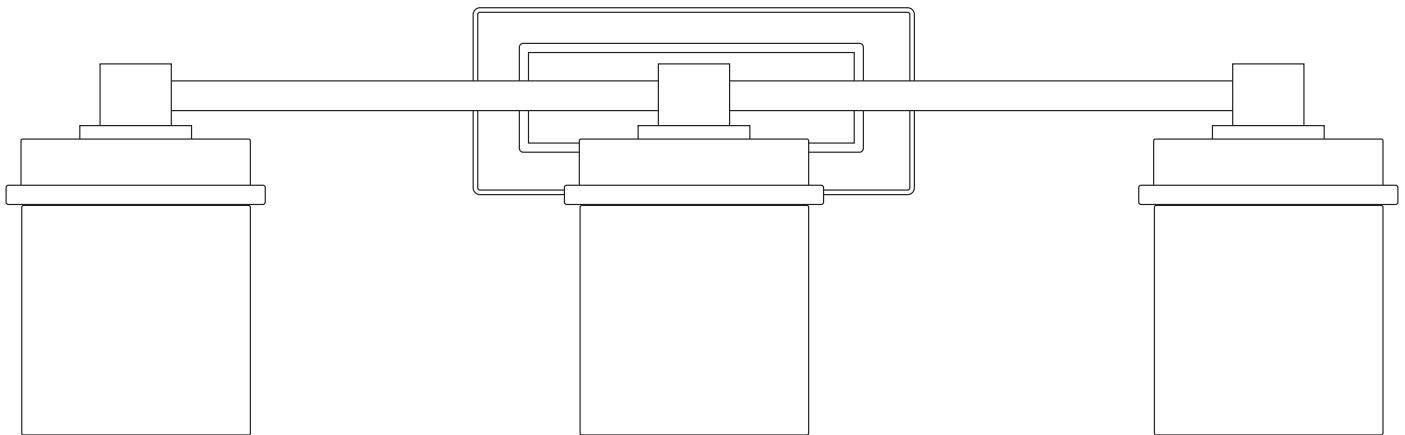

Questions, problems, missing parts? Before returning to the store,
call Hampton Bay Customer Service
8 a.m. - 7 p.m., EST, Monday – Friday, 9 a.m. – 6 p.m., EST, Saturday

1-855-HD-HAMPTON

HAMPTONBAY.COM

THANK YOU

We appreciate the trust and confidence you have placed in Hampton Bay through the purchase of this light fixture. We strive to continually create quality products designed to enhance your home. Visit us online to see our full line of products available for your home improvement needs. Thank you for choosing Hampton Bay!

Table of Contents

Table of Contents	2	Hardware Included	3
Safety Information	2	Package Contents	4
Warranty	2	Installation	5
Pre-Installation	3	Operation	6
Planning Installation	3	Care and Cleaning	6
Tools Required	3	Troubleshooting	6

Safety Information

- Consult a qualified electrician if you have any electrical questions.

 **CAUTION:** Inspect the wire insulation for any cuts, abrasions, or exposed copper that may have resulted during shipping. If there is a defect in the wire, do not attempt installation. Please call our Customer Service Team at 1-855-HD-HAMPTON.

 **WARNING:** Before starting installation of this fixture or removal of a previous fixture, disconnect the power by turning off the circuit breaker or by removing the fuse at the fuse box.

Warranty

The manufacturer warrants this lighting fixture to be free from defects in materials and workmanship for a period of two (2) years from date of purchase. This warranty applies only to the original consumer purchaser and only to products used in normal use and service. If this product is found to be defective, the manufacturer’s only obligation, and your exclusive remedy, is the repair or replacement of the product at the manufacturer’s discretion, provided that the product has not been damaged through misuse, abuse, accident, modifications, alterations, neglect, or mishandling. This warranty shall not apply to any product that is found to have been improperly installed, set-up, or used in any way not in accordance with the instructions supplied with the product. This warranty shall not apply to a failure of the product as a result of an accident, misuse, abuse, negligence, alteration, faulty installation, or any other failure not relating to faulty material or workmanship. This warranty shall not apply to the finish on any portion of the product, such as surface and/or weathering, as this is considered normal wear and tear. The manufacturer does not warrant and specially disclaims any warranty, whether express or implied, of fitness for a particular purpose, other than the warranty contained herein. The manufacturer specifically disclaims any liability and shall not be liable for any consequential or incidental loss or damage, including but not limited to any labor / expense costs involved in the replacement or repair of said product.

Contact the Customer Service Team at 1-855-HD-HAMPTON or visit www.HAMPTONBAY.com.

Pre-Installation

PLANNING INSTALLATION

- ❑ Read all instructions before installation.
- ❑ This fixture can be installed as an up-light or as a down-light.
- ❑ To avoid damaging this product, assemble it on a soft, non-abrasive surface, such as carpet or cardboard.
- ❑ Keep your receipt and these instructions for proof of purchase.

TOOLS REQUIRED

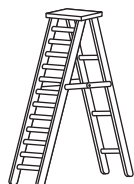

Ladder



Safety goggles



Electrical tape



Phillips screwdriver

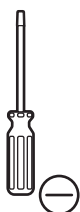

Flat blade screwdriver



Pliers



Wire strippers

HARDWARE INCLUDED



NOTE: Hardware not shown to actual size.

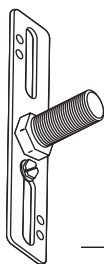

AA

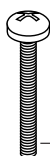

BB



CC

Part	Description	Quantity
AA	Mounting bracket	1
BB	Mounting screw	2
CC	Wire nut	3

Pre-Installation (continued)

PACKAGE CONTENTS

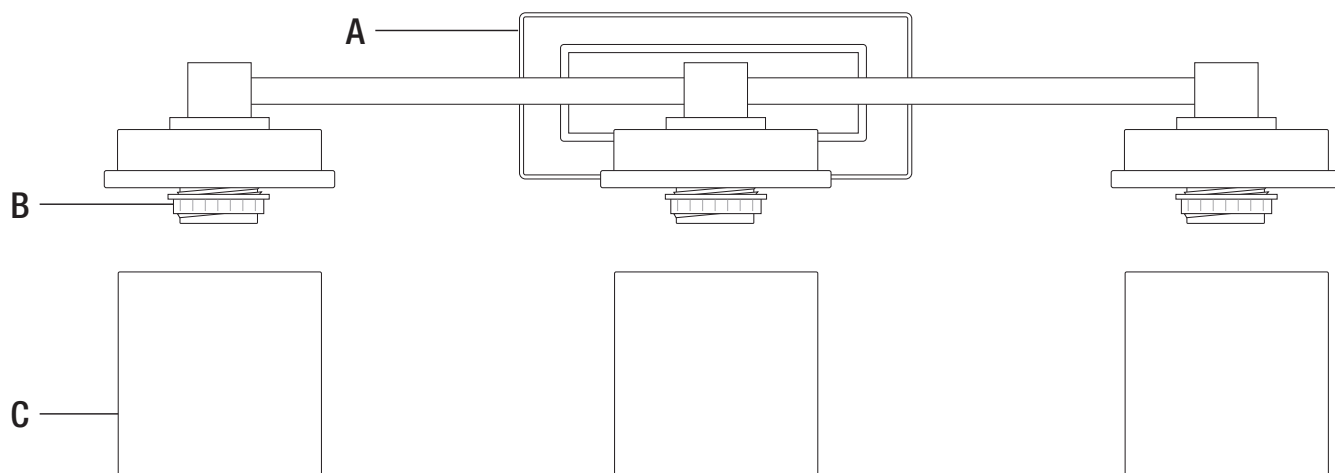

Part	Description	Quantity
A	Light fixture	1
B	Socket ring	3
C	Shade	3

Installation

1 Attaching the mounting bracket to the junction box

- Remove the preinstalled cap nut from the mounting unit (AA) and put it in a safe location.
- Attach mounting unit (AA) to the junction box (not included) with mounting screws (BB).



NOTE: The preinstalled support screws on the mounting unit (AA) should protrude out away from the junction box.

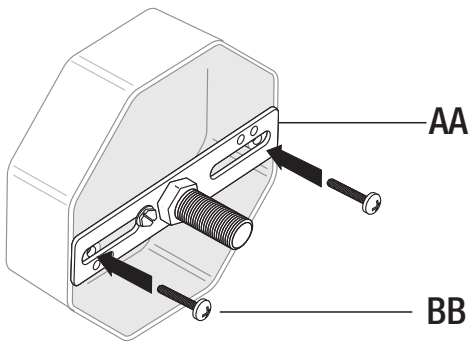

2 Making the electrical connections

- Connect the copper wire on the light fixture (A) to the mounting bracket (AA) by securing it with the preinstalled ground screw.
- Connect the black to black (power), the white to white (neutral) and copper wire to ground wire with the wire nuts (CC) and secure with electrical tape (not included).



NOTE: If the wires from the fixture are the same color, attach the side with markings or letters to the black (positive) wire and the other to the white (neutral) wire.

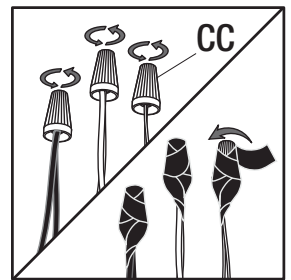
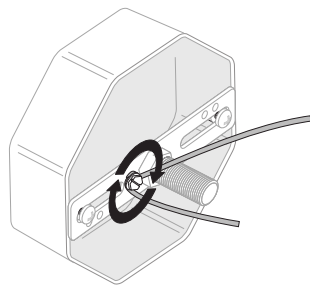

3 Securing the light fixture

- Secure the light fixture (A) to the junction box by placing it over the preinstalled pipe nipple on the mounting unit (AA) and securing with the previously removed cap nut.
- Remove the preinstalled socket ring (B), add shade (C) and re-secure the socket ring (B).



NOTE: Light fixture (A) can be installed with the socket facing either up or down.

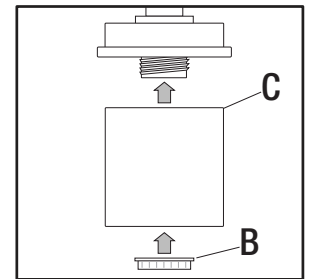
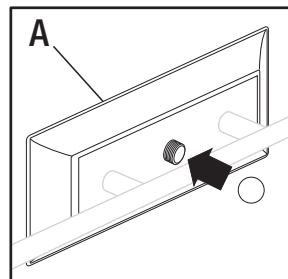

4 Installing the light bulbs

- Install three 60-watt max. medium- base incandescent bulbs or three 13-watt max. CFL bulbs (none included).

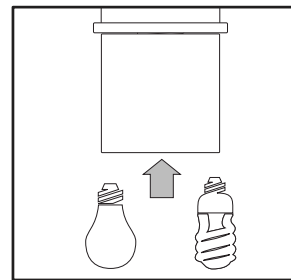

Operation

1 Secure the light fixture

- Turn the light switch on to activate the fixture.

Care and Cleaning

- Clean the lamp with a soft, dry cloth.
- Do not use any cleaners with chemicals, solvents, or harsh abrasives.

Troubleshooting

Problem	Possible Cause	Possible Cause
The bulb will not light.	The bulb is burned out.	Replace the light bulb.
	The power is off.	Ensure the power supply is On.
	There is a faulty wire connection.	Check the wiring.
	The circuit breaker is off.	Ensure the circuit breaker is in the ON position.
The fuse blows or circuit breaker trips when the light is turned on.	There are crossed wires or the power wire is grounding out.	Check the wire connections. Contact a qualified electrician or call the Customer Service Team at 1-855-HD-HAMPTON.

HAMPTON BAY[®]

Questions, problems, missing parts? Before returning to the store,
call Hampton Bay Customer Service
8 a.m. – 7 p.m., EST, Monday – Friday, 9 a.m. – 6 p.m., EST, Saturday

1-855-HD-HAMPTON

HAMPTONBAY.COM

Retain this manual for future use.