

**MALLORCA
66"x40" SQUARE ROUND DINING TABLE**

IMPORTANT: PLEASE READ COMPLETE INSTRUCTION SHEET PRIOR TO ASSEMBLY!

Identify all parts packed in carton against the parts list. Remove all protective materials, place parts on a nonabrasive surface to avoid scratching. If any parts are missing or damaged, DO NOT attempt to assemble. Please contact our customer service center (Monday-Friday 9:00 a.m.-5:00 p.m.CST) at 1-877-527-0313 or visit our website at www.homedepot.com.

STEP 1

Remove the glass and set aside vertically in a safe place until the table has been completely assembled. Turn the table rim (A) upside down. Attach 4 table legs (B) to the table rim (A) by inserting bolts (E) with metal washers (F) through the pre-drilled holes in the table rim and legs. Do not tighten the bolts.

STEP 2

Attach the leg connector bracket (C) to the table legs (B) by inserting bolts (E) with metal washers (F) through the pre-drilled holes in the leg connector bracket and legs. Tighten all bolts completely and cover them with plastic bolt caps (G). Important note: Each bolt should be tightened a few revolutions at a time, alternating between bolts in a cross corner (X) pattern. This will ensure your table is level by placing equal pressure on all bolt joints. Do not over tighten.







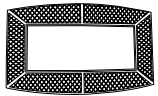

STEP 3

Turn the table in the upright position. Carefully place glass (D) into the table rim. Keep touch-up paint (I) for future use for both your table and chairs. Your table is now ready for use.

IMPORTANT:

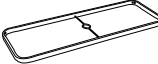
To avoid damage to your table:

- An umbrella base must be used at all times.
- Make sure the plastic umbrella safety ring is installed in the center of the table before you insert the umbrella pole through the table.
- Remove the umbrella from the table when not in use or in the event of wind, rain, hail, sleet, snow or any other inclement weather.
- In storing patio furniture, do not stack anything on glass, stone, or marble tabletops.
- Before storing, drain all water that may have accumulated in or around patio furniture frames. If not drained properly, water can cause freeze damage.
- Cover furniture with outdoor furniture covers when not in use.
- For safety reasons, do not sit or stand on the table.

Parts List							
A	TABLE RIM		1	F	METAL WASHER		12
B	TABLE LEG		4	G	PLASTIC BOLT CAP		12
C	LEG CONNECTOR BRACKET		1	H	ALLEN WRENCH		1
D	GLASS		1	I	TOUCH-UP PAINT		1
E	BOLT (M6X15)		12				

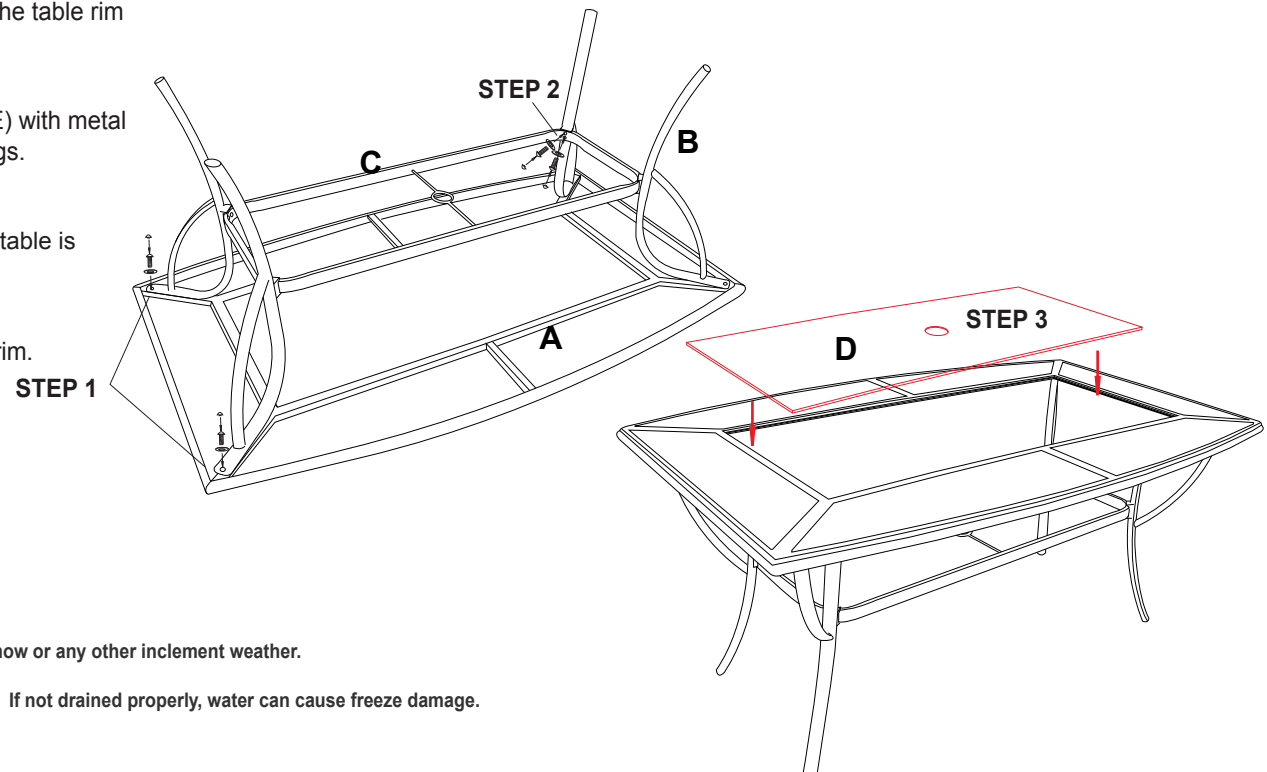

MALLORCA SWIVEL CHAIR WITH CUSHION

IMPORTANT: PLEASE READ COMPLETE INSTRUCTION SHEET PRIOR TO ASSEMBLY!
Identify all parts packed in carton against the parts list. Remove all protective materials, place parts on a nonabrasive surface to avoid scratching. If any parts are missing or damaged, DO NOT attempt to assemble. Please contact our customer service center (Monday-Friday 9:00 a.m.-5:00 p.m.CST) at 1-877-527-0313 or visit our website at www.homedepot.com.

Step 1

Place chair frame (A) upside down on a flat surface. Align T-rock (C) on chair frame (A).
NOTE: T-rock aligns on top of chair frame A crossbar. (FIG.1)

Step 2

Attach T-rock (C) to chair frame (A) with bolt (D) in the order of bolt (D), metal washer (F), rectangular steel plate (G), chair frame (A), T-rock (C), metal washer (F), nut (E). (FIG.2)
NOTE: Bolts are inserted from underneath seat (closest to seat fabric or straps) through crossbar into T-rock. One rectangular steel plate is used for each side in sequence as noted in Step 2, sentence one.

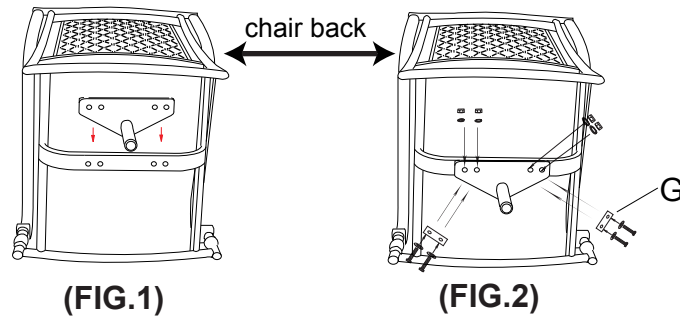

Step 3











Tighten all bolts (D) and nuts (E) by using hex wrenches (J).

Step 4

Cover all bolts and nuts with plastic bolt and nut caps (H&I).

Step 5

Insert the chair frame into the chair base by using a twisting motion as you insert. Place cushion on chair. Your chair is now ready for use.

Parts List							
A	CHAIR FRAME		2	F	METAL WASHER		16
B	CHAIR BASE		2	G	RECTANGULAR STEEL PLATE		4
C	T-ROCK		2	H	PLASTIC BOLT CAP		8
D	BOLT (M8x40)		8	I	PLASTIC NUT CAP		8
E	NUT		8	J	HEX WRENCH		2

