

Assembly Instructions

Caution: You must read this before you proceed

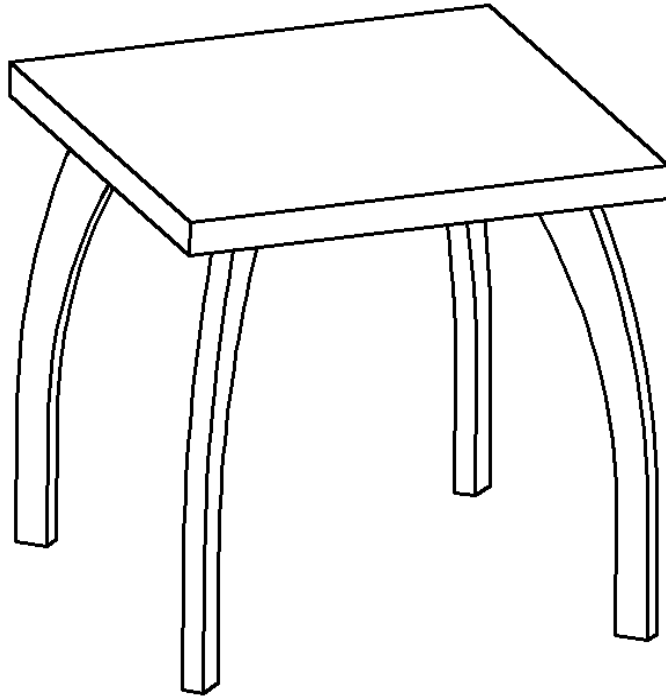

Table



Parts List

Label	Picture	Description	QTY
A	A line drawing of a square table top frame, showing the internal support structure.	Table Top	1
B	A line drawing of a single curved leg, showing its shape and the small feet at the base.	Leg	4

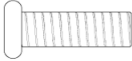
Hardware

Label	Picture	Description	QTY
①		Bolt Cover	9
②		Bolt M6*20mm	9
③		Washer	9
④		Allen Key	1

Assembly Preparation

Before Beginning Assembly:

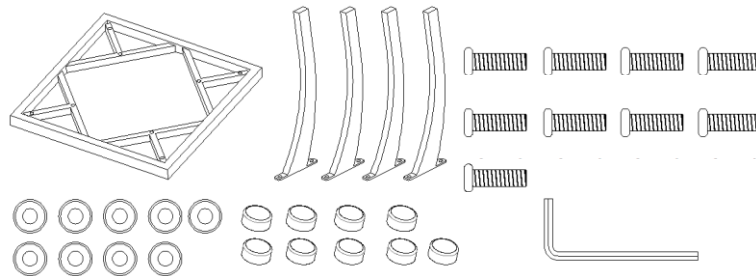

- Read instructions, cover to cover-



- Have 2 adults on hand for assembly-



- Do not assemble on flooring or carpet-



- Assemble on a clean non-marring surface (packing foam)-



- Save all packaging until finished-

Assembly Steps

Overview

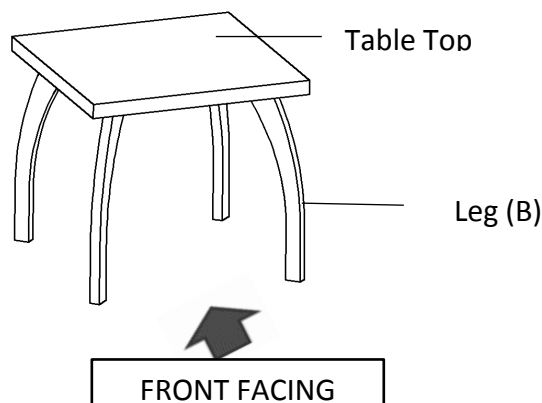

This Table has multiple parts and may require up to 30 minutes to assemble. To give you an overview of the Table parts, the above picture is to help you put the various parts into perspective. Please read through the instructions below to familiarise yourself with the parts and steps before assembly.

Step 1

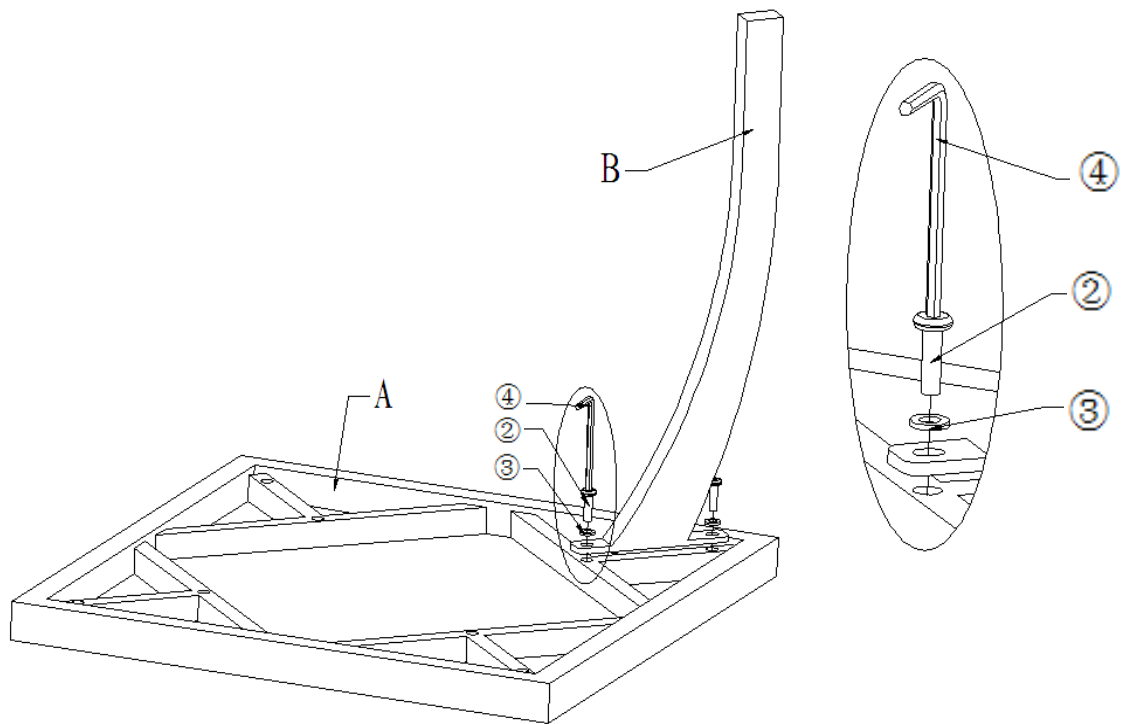

Open the carton and place all the parts onto a clean, non-marring surface.
Attach Leg(B) onto the Table Top(A) using Bolt(2) and Washer(3) with Allen Key(4).
Only loosely tighten Bolts.

Step 2

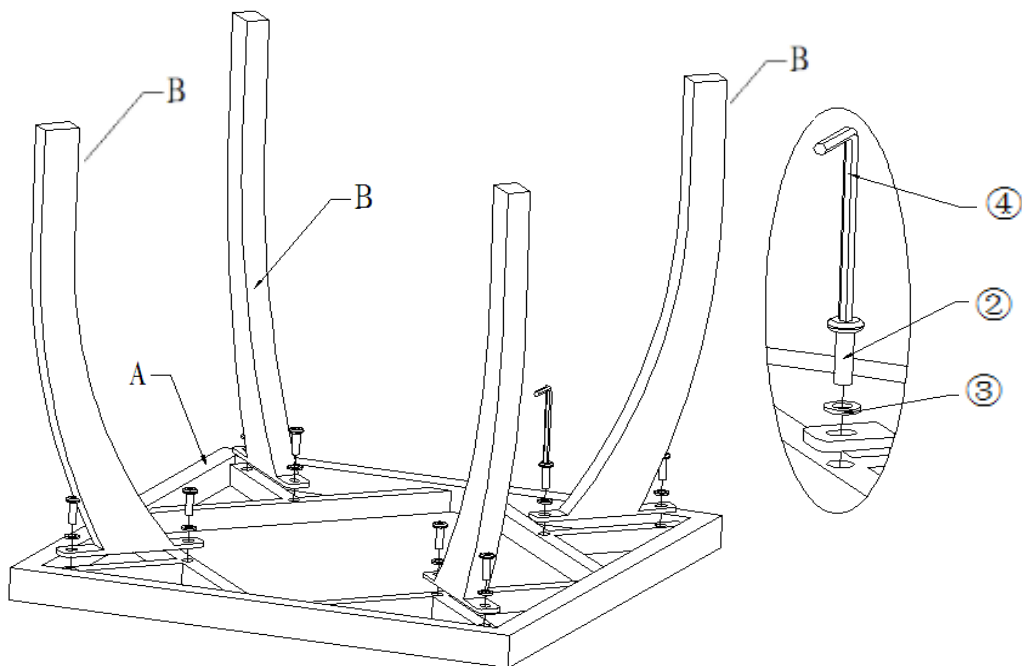

Repeat Step 1 with the remaining three Legs(B).
Only loosely tighten Bolts.

Step 3

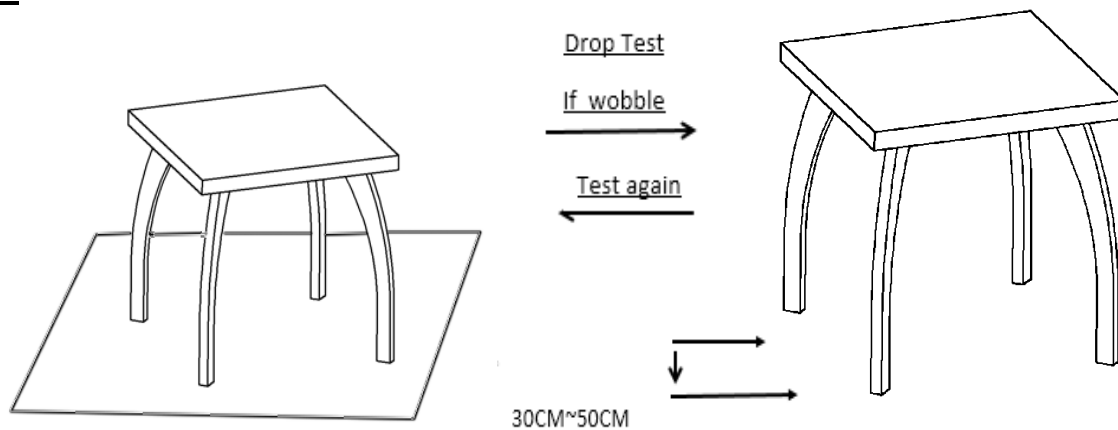

Stand the Table right way up. Place the Table on a LEVEL SURFACE to check for wobbles. If it wobbles, lift the table some 20cm to 30cm high from the ground. Keep your feet and toes well away from the drop zone. Drop the table freely and vertically with all four legs, hitting the ground, at the same time. This Drop Test will help to ensure that all Bolts and gaps reach full alignment status. Test again for evenness on a LEVEL SURFACE. If no wobbles are found, slowly and carefully, turn the Table facedown. Then, proceed to tighten all Bolts in a sequential manner.

When tightening the Bolts, tighten sequentially.

DO NOT tighten any Bolt fully and then towards the next one.

This could cause the frame to warp. If there are still wobbles, loosen the Bolts and execute the same drop test.

If the Table is not stable, it could lead to damage to the product.





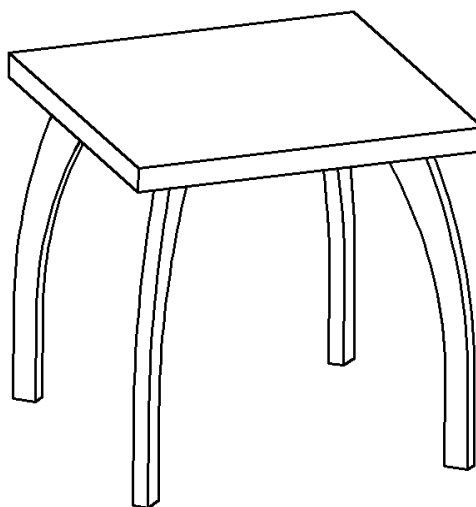

























Put the Bolt Covers(①) over all of the Bolts(②).

Step 4



Your Table is ready for use.
This Table can only be used on a flat, level surface.

Care & Maintenance

-    Do not put hot items directly on furniture surface
 -    Do not clean furniture with harsh cleansers or polish.
 -    To obtain the longest lifespan of your outdoor products, minimizing exposure to direct sunlight is recommended.
 -    Children should not climb or jump on the furniture.
 -    Do not write on furniture without a padded barrier to protect the surface.
 -    To obtain the longest lifespan of your outdoor products, avoid extended and lengthy exposure to rain, snow, and direct sunshine. Whenever possible cover the product and /or place under patio or awnings.
 -    Not for commercial use. For residential use only .
 -    Stains may be removed with mild soap solution and damp cloth.
 -    Keep away from sources of ignition.
-
-    Dust and pick-up spills using a clean, non-colored, lint-free cloth .

What is Proposition 65?

Proposition 65 is a California law that requires warning labels on products that may contain one of more than 800-plus chemicals or ingredients that the California Office of Environmental Health Hazard Assessment (OEHHA) has deemed to cause cancer or other reproductive toxicity. Chemicals and elements on this list include wood dust, brass, and other everyday substances, which can be found in very common household items, such as: lamps, tableware, jewelry, crystal glasses, electric cords, beauty products, automobiles, and furniture.

Why Did I Find a Proposition 65 Warning on My Home Goods Product?

We include Proposition 65 warnings on all of our products because there is always a chance that one of the 800-plus common chemicals and ingredients listed under this law could potentially be on our furniture or packing materials. We risk large fines under this law, if we don't include this warning.

Should I worry?

We realize you may be worried finding this warning on our products, but we want to reassure you that the hazardous exposure limits for any of these chemicals have never been found on furniture products that we've shipped to our customers. Additionally, this warning label is very common and can be found on almost every piece of furniture sold in the state of California.

Just How Common Are Proposition 65 Warnings?

Proposition 65 warnings have become so common in California that it is hard to take a trip to a local bank, grocery store, or restaurant without finding at least one warning. In fact, even the Disney Land Resort has a Proposition 65 warning:

