



APPLIANCES

INSPIRING THE WORLD'S KITCHEN



36 IN. DUAL FUEL
FREESTANDING RANGE
965 SERIES

F965 / F965NF

USER MANUAL & CARE GUIDE

IMPORTANT SAFETY INSTRUCTIONS

Carefully read the following Important information regarding installation safety and maintenance. Keep these instruction for future reference.

USER MANUAL

THANK YOU FOR YOUR PURCHASE

Thank you for your purchase. We know that you have many brands and products to choose from and we are honored to know that you have decided to take one of our products into your home and hope that you enjoy it.

COSMO appliances are designed according to the strictest safety and performance standard for the North American market. We follow the most advanced manufacturing philosophy. Each appliance leaves the factory after thorough quality inspection and testing. Our distributors and our service partners are ready to answer any questions you may have regarding how to install, use and care for your products. We hope that this manual will help you learn to use the product in the safest and most effective manner .

If you have any questions or concerns, please contact the dealer from whom you purchased it, or contact our Customer Support at:

1-888-784-3108.



TABLE OF CONTENTS

Safety Instructions	3-9
Ventilation Requirements	10-12
Gas Supply Requirements	13
Type of Gas	13-16
Electrical Requirements	17
Advance Preparation	18
Tools and Parts	18
Range Dimensions	19
Unpack Range	20
Install Leveling Feet and Back Panel	20
Install Anti-Tip Bracket (Model F965NF Only)	21-22
Install Anti-Tip Chain (Model F965 Only)	23
Installation Instructions	24
Gas Connection	24-27
Liquefied Petroleum (Propane) Gas Conversion	28-32
Electrical Connection	33-34
Power Cord Installation Instructions	35-39
Using the Cooktop	40
Flame Size	40
Proper Burner Adjustments	40
Location of the Burners	41
Placement of Burner Heads and Caps	41
Cooktop Using Pots and Pans	42
Setting Cooktop Controls	43
Oven Cooking	44
Setting Oven Clock and Timer	44
Setting Oven Controls	45-47
Cooking Instructions	48
Care and Cleaning	49-52
Solutions to Common Problems	53-56
Warranty and Service	57-58



IMPORTANT SAFETY INSTRUCTIONS

BEFORE YOU BEGIN:

Please Read all instructions completely and carefully.

Save these instructions for future references.

We have provided many important safety messages in this manual and on your appliance. Always read and obey all safety messages.



This is the safety alert symbol.

This symbol alerts you to potential hazards that can kill or hurt you and others.

All safety messages will follow the safety alert symbol and either the word "DANGER" or "WARNING."

These words mean:

DANGER

You can be killed or seriously injured if you don't immediately follow instructions.

WARNING

You can be killed or seriously injured if you don't follow instructions.

All safety messages will tell you what the potential hazard is, how to reduce the chance of injury, and what can happen if the instructions are not followed.

•  Remove all tape and packaging before using the appliance. Never allow children to play with packaging material. Do not remove the model/serial plate attached to the appliance.

•  Be sure your appliance is properly installed and grounded by a QUALIFIED TECHNICIAN in accordance with the National Fuel Gas Code ANSI Z223.1—latest edition in the United States, or in Canada CAN/CGA B149.1, and CAN/CGA B149.2, and the National Electrical Code ANSI/NFPA No. 70—latest edition in United States, or in Canada CSA Standard C22.1, Canadian Electrical Code, Part 1, and local code requirements. Install only as per installation instructions provided in the literature package for this appliance.

WARNING

If the information in this manual is not followed exactly, a fire or explosion may result causing property damage, personal injury or death.

• FOR YOUR SAFETY:

- Do not store or use gasoline or other flammable vapors and liquids in the vicinity of this or any other appliance.

• WHAT TO DO IF YOU SMELL GAS:

- Do not try to light any appliance.
- Do not touch any electrical switch; do not use any phone in your building.
- Immediately call your gas supplier from a neighbor's phone. Follow the gas supplier's instructions.
- If you cannot reach your gas supplier, call the fire department.

WARNING

- Gas leaks cannot always be detected by smell.
- Gas suppliers recommend that you use a gas detector approved by UL or CSA.
- For more information, contact your gas supplier.
- If a gas leak is detected, follow the "What to do if you smell gas" instructions.

In the State of Massachusetts, the following installation instructions apply:

- Installations and repairs must be performed by a qualified or licensed contractor, plumber, or gasfitter qualified or licensed by the State of Massachusetts.
- If using a ball valve, it shall be a T-handle type.
- A flexible gas connector, when used, must not exceed 3 feet.

•  Installation and service must be performed by a qualified installer, servicer or the gas supplier. Ask your dealer to recommend a qualified technician and an authorized repair service. Know how to shut off gas supply at the meter and disconnect the electrical power to the appliance at the circuit breaker or fuse box in case of an emergency.









- **⚠** Do not repair or replace any part of the appliance unless specifically recommended in the manuals. All other servicing should be done only by a qualified technician. This may reduce the risk of personal injury and damage to the appliance.
- **⚠** Proper Installation – The range, when installed, must be electrically grounded in accordance with local codes or, in the absence of local codes, with the *National Electrical Code, ANSI/NFPA 70*. In Canada, the range must be electrically grounded in accordance with Canadian Electrical Code. Be sure the range is properly installed and grounded by a qualified technician.
- **⚠** Disconnect power before servicing.
- **⚠** Never modify or alter the construction of the appliance by removing panels, wire covers or any other part of the product.
- **⚠** Injuries may result from the misuse of appliance doors or drawers such as stepping, leaning, or sitting on the doors or drawers.
- **⚠** Overhead range hoods, which operate by blowing a downward air flow on to a range, shall not be used in conjunction with gas ranges other than when the hood and range have been designed, tested and listed by an independent test laboratory for use in combination with each other.
- **⚠** Ensure that the room is well ventilated by keeping the air intakes open and in good working order or by installing an extractor hood with discharge pipe. If the appliance is used intensively for a long time the effectiveness of the ventilation will have to be increased, for example by opening a window or increasing the power of any electric extractor fan.
- **⚠** Flammable materials should not be stored on the appliance or near surface units. This includes paper, plastic and cloth items, such as cookbooks, plastic ware and towels, as well as flammable liquids. Do not store explosives, such as aerosol cans, on or near the appliance. Flammable materials may explode and result in fire or property damage.







- **⚠** Maintenance – Keep range area clear and free from combustible materials, gasoline, and other flammable vapors and liquids.
- **⚠** Storage in or on the Range – Flammable materials should not be stored in an oven or near surface units.

⚠ DANGER

Do not store items of interest to children in the cabinets above the appliance or on the backguard of a range. Children should not be left alone or unattended in the area where appliance is in use. Do not allow children to climb or play around the appliance. They should never be allowed to sit or stand on any part of the appliance. Children climbing on the appliance to reach items could be seriously injured.

- **⚠ DO NOT TOUCH THE COOKING SURFACE, THE BURNERS, GRATES OR ANY AREAS NEAR THEM.** Surface burners or appliance may be hot even though flames are not visible. Areas near surface burners or appliance may become hot enough to cause burns. During and after use, do not touch, or let clothing or other flammable materials touch these areas until they have had sufficient time to cool.
- **⚠** Do not wear loose-fitting or hanging garments while using the appliance. Do not let clothing or other flammable materials contact hot surfaces.
- **⚠** Smother grease fires with a pan lid, or use baking soda, a dry chemical or foam-type extinguisher.
- **⚠** Use an extinguisher **ONLY** if:
 - You know you have a Class A, B, C extinguisher, and you already know how to operate it.
 - The fire is small and contained in the area where it is started.
 - The fire department is being called.
 - You can fight the fire with your back to an exit.

-  When heating fat or grease, watch it closely. Fat or grease may catch fire if allowed to become too hot.
-  Use only dry potholders. Moist or damp potholders on hot surfaces may result in burns from steam. Do not let potholders touch hot heating elements, the flame or burners. Do not use a towel or other bulky cloth instead of a potholder.
-  Do not heat unopened food containers. Buildup of pressure may cause the container to burst and result in injury.
-  Stepping, leaning or sitting on this appliance can result in serious injuries and also cause damage to the appliance.
-  Never use this appliance as a space heater to heat or warm the room. Doing so may result in carbon monoxide poisoning and overheating of the oven.
-  Know which knob controls which cooktop burner. Visually check that the burner has lit. Then adjust the flame so it does not extend beyond the edge of the pots and pans.
-  Clean the appliance regularly to keep all parts free of grease that could catch fire. Exhaust fan ventilation hoods and grease filters should be kept clean. Do not allow grease to accumulate on hood or filter. Greasy deposits in the fan could catch fire. When cooking food turn the hood, fan on. Refer to hood manufacturer's instructions for cleaning.
-  Utensil handles should be turned inward and not extend over adjacent surface burners. To reduce the risk of burns, ignition of flammable materials, and spillage due to unintentional contact with the utensil, the handle of the utensil should be positioned so that it is turned inward, and does not extend over adjacent surface burners.
-  Never leave surface burners unattended at high heat settings. Boil overs cause smoke and greasy spillovers that may ignite, or a pan that has boiled dry may melt.

-  Do not use aluminum foil to line any part of the appliance. Use aluminum foil only to cover food during cooking. Improper installation of these liners may result in risk of electric shock or fire.
-  Only certain types of glass, glass/ceramic, ceramic, earthenware, or other glazed utensils are suitable for appliance service without breaking due to the sudden change in temperature. Check the manufacturer's recommendations for appliance use.
-  Do not use decorative surface burner covers. If a burner is accidentally turned on, the decorative cover will become hot and possibly melt. You will not be able to see that the burner is on. Burns will occur if the hot covers are touched. Damage may also be done to the range or burners because the covers may cause overheating. Air will be blocked from the burner and cause combustion problems.
-  Always use proper flame size. Adjust flame size so it does not extend beyond the edge of the utensil. The use of undersized utensils will expose a portion of the burner flame to direct contact and may result in ignition of clothing. Proper relationship of utensil to flame will also improve efficiency.
-  Top burner flame size should be adjusted so it does not extend beyond the edge of the cooking utensil.
-  Use the proper pan sizes. This appliance is equipped with surface units of different sizes. Select utensils having flat bottoms large enough to cover the surface unit. The use of undersized utensils will expose a portion of the surface heating unit to direct contact and may result in ignition of clothing. Proper relationship of utensil to the surface unit will also improve efficiency.
-  Do not use stove top grills on your gas appliance. If you use a stove top grill on a sealed gas burner, it will cause incomplete combustion and can result in exposure to carbon monoxide levels above allowable current standards. This can be hazardous to your health.

⚠ WARNING

TO REDUCE THE RISK OF TIPPING OF THE RANGE, THE RANGE MUST BE SECURED BY PROPERLY INSTALLED ANTI-TIP DEVICES. TO CHECK IF THE DEVICES ARE INSTALLED PROPERLY, SLIDE RANGE FORWARD, LOOK FOR ANTI-TIP DEVICE SECURELY ATTACHED TO WALL.

- ⚠ The range will not tip during normal use. However, the range can tip if you apply too much force or weight to the open door without having the anti-tip bracket fastened down properly.

⚠ DANGER

TIP OVER HAZARD



A child or adult can tip the range and be killed.

Connect anti-tip chain to wall.

Reconnect the anti-tip chain, if the range is moved.

See the installation instructions for details.

Failure to follow these instructions can result in death or serious burns to children and adults.

VENTILATION REQUIREMENTS

⚠ WARNING

The range should have proper ventilation in order to keep the unit operating properly and maintain the temperature of immediate surroundings within safe limits. Check your local building codes as they may vary from the general rules outlined in this guide. It is recommended that a hood be installed above the range that is rated no less than 400 CFM. This will provide adequate ventilation for this range. Mounting distance of your ventilation is outlined by the manufacturer of your hood and is dependent on the total BTU output of your range.

- ⚠ Observe all governing codes and ordinances. Do not obstruct flow of combustion and ventilation air.
- ⚠ It is the installer's responsibility to comply with installation clearances specified on the model/serial rating plate.
- ⚠ For proper operation of a gas appliance, the air necessary for the combustion of the gas must be able to flow into the room naturally. The air must flow into the room directly through openings in the outside walls. These openings must have an unobstructed cross-section not less than $2\text{m}^3/\text{h}$ for each kw of power (see total power in kw on the appliance).
- ⚠ This opening must be constructed so that it will not be obstructed from inside or outside, and not be constructed close to the floor. The opening is recommended to be on the side opposite to that on which the flue gases are discharged.
- ⚠ The range should be located for convenient use in the kitchen.
- ⚠ Recessed installations must provide complete enclosure of the sides and rear of the range.

- **⚠** To eliminate the risk of burns or fire by reaching over heated surface units, cabinet storage space located above the surface units should be avoided. If cabinet storage is to be provided, the risk can be reduced by installing a range hood or microwave hood combination with minimum 400 CFM that projects horizontally a minimum of 5" (12.7 cm) beyond the bottom of the cabinets. (See Figure 1)

- **⚠** If a range hood is installed above the appliance, maintain a 30" minimum clearance between cooking surface and bottom of range hood. The range hood must be connected directly to flues or to the outside. (See Figure 1)

- **⚠** All openings in the wall or floor where range is to be installed must be sealed.

- **⚠** Contact a qualified floor covering installer to check that the floor covering can withstand at least 200°F (93°C).

- **⚠** Use an insulated pad or ¼" (0.64 cm) plywood under range if installing range over carpeting.

- **⚠** Avoid placing cabinetry directly above the appliance when possible. If cabinetry is used above the cooking surface, use cabinets no more than 13" deep. Make sure the wall coverings, countertop and cabinets around the appliance can withstand heat up to 200° F (93°C) generated by the appliance. (See Figure 1)

- **⚠** Cabinet opening dimensions that are shown must be used. Given dimensions are minimum clearances. (See Figure 1)

- **⚠** Working areas adjacent to the range should have 18" minimum clearance between countertop and cabinet bottom. (See Figure 1)

- **⚠** The floor anti-tip bracket must be installed. To install the anti-tip bracket shipped with the range, see "Install Anti-Tip Bracket" section.

- **⚠** Grounded electrical supply is required. See "Electrical Requirements" section.

- **⚠** Proper gas supply connection must be available. See "Gas Supply Requirements" section.

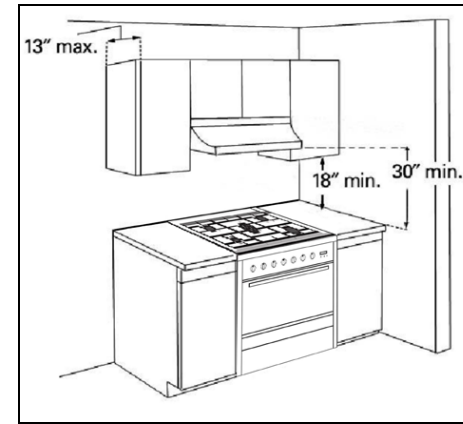

Figure 1

⚠ WARNING

To avoid damage to your cabinets, check with your builder or cabinet supplier to make sure that the materials used will not discolor, delaminate or sustain other damage. This oven has been designed in accordance with the requirements of UL and CSA International and complies with the maximum allowable wood cabinet temperatures of 194°F (90°C).

MOBILE HOME – ADDITIONAL INSTALLATION REQUIREMENTS

- **⚠** The installation of this range must conform to the Manufactured Home Construction and Safety Standard, Title 24 CFR, Part 3280 (formerly the Federal Standard for Mobile Home Construction and Safety, Title 24, HUD Part 280). When such standard is not applicable, use the Standard for Manufactured Home Installations, ANSI A225.1/NFPA 501A or with local codes.

In Canada, the installation of this range must conform with the current standards CAN/CSA-A240-latest edition, or with local codes.

MOBILE HOME INSTALLATIONS REQUIRE:

- **⚠** When this range is installed in a mobile home, it must be secured to the floor during transit. Any method of securing the range is adequate as long as it conforms to the standards listed above.

GAS SUPPLY REQUIREMENTS

⚠ DANGER

EXPLOSION HAZARD



Use a new CSA International approved gas supply line.

Install a shut-off valve.

Securely tighten all gas connections.

If connected to LP, have a qualified person make sure gas pressure does not exceed 14" (36 cm) water column.

Examples of a qualified person include:

- Licensed heating personnel
- Authorized gas company personnel
- Authorized service personnel

Failure to do so can result in death, explosion, or fire.

Type of Gas

NATURAL GAS:

- This range is designed for use with Natural gas or, after proper conversion, for use with LP gas.
- This range is factory set for use with Natural gas. The model/serial rating plate has information on the types of gas that can be used. If the types of gas listed do not include the type of gas

available, check with the local gas supplier.

LP GAS CONVERSION:

- Conversion must be done by a qualified service technician.
- No attempt shall be made to convert the appliance from the gas specified on the model/serial rating plate for use with a different gas without consulting the serving gas supplier.

⚠ WARNING

- ⚠ Observe all governing codes and ordinances.

IMPORTANT: This installation must conform with all local codes and ordinances. In the absence of local codes, installation must conform with American National Standard, National Fuel Gas Code ANSI Z223.1 - latest edition or CAN/CGA B149 - latest edition.

IMPORTANT: Leak testing of the range must be conducted according to the manufacturer's instructions.

GAS SUPPLY LINE:

- Provide a gas supply line of 3/4" (1.9 cm) rigid pipe to the range location. A smaller size pipe on longer runs may result in insufficient gas supply. Pipe-joint compounds that resist the action of LP gas must be used. Do not use TEFLON®† tape. With LP gas, piping or tubing size must be 1/2" (1.3 cm) minimum. Usually, LP gas suppliers determine the size and materials used in the system.

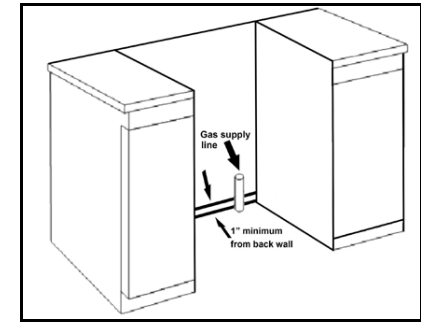

Figure 2

- Gas supply should be located near the opening for this appliance and be a minimum of 1" from the back wall. (See Figure 2)

FLEXIBLE METAL APPLIANCE CONNECTOR:

⚠ WARNING

Never reuse old flexible connectors. The use of old flexible connectors can cause gas leakage and personal injury. Always use new flexible connectors when installing a gas appliance. To reduce the possibility of gas leakage, apply Teflon tape or a thread compound approved for use with LP or Natural gases to all threaded connections.

- If local codes permit, a new CSA design-certified, 4 to 5 ft (122 to 152.4 cm) long, 1/2" (1.3 cm) or 3/4" (1.9 cm) I.D., flexible metal appliance connector may be used for connecting range to the gas supply line. (See Figure 3)

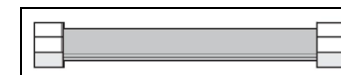

Figure 3

- A 1/2" (1.3 cm) male pipe thread is needed for connection to the female pipe threads of the inlet to the appliance pressure regulator.
- Do not kink or damage the flexible metal tubing when moving the range.

RIGID PIPE CONNECTION:

- The rigid pipe connection requires a combination of pipe fittings to obtain an in-line connection to the range. The rigid pipe must be level with the range connection. All strains must be removed from the supply and fuel lines so range will be level and in line. (See Figure 4)

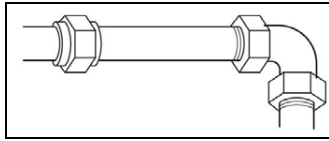

Figure 4

MUST INCLUDE A SHUTOFF VALVE:

- The supply line must be equipped with a manual shutoff valve. This valve should be located in the same room but external to the range in an easily accessible location. It should be in a location that allows ease of opening and closing. Do not block access to shutoff valve. The valve is for turning on or shutting off gas to the range. (See Figure 5)
- Be sure you know where and how to shut off the gas supply to the range.

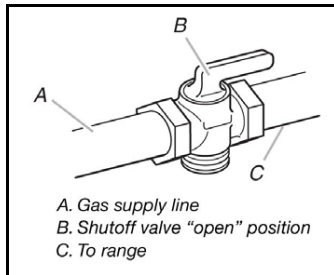

Figure 5

GAS PRESSURE REGULATOR:

- The pressure regulator must be connected in series with the manifold of the appliance and must remain in series with the supply line regardless the type of gas being used.
- For proper operation, the gas pressure regulator supplied with this range must be used. The inlet pressure to the regulator should be as follows:

NATURAL GAS

NATURAL GAS NOZZLES

BURNER	POSITION	NOZZLE DIAMETER	MINIMUM PRESSURE	MAXIMUM PRESSURE
Auxiliary	Front Right	1 x 1.10	4"	14"
Semi-Rapid	Rear Left & Right	2 x 1.29	4"	14"
Rapid	Front Left	1 x 1.45	4"	14"
Triple Ring	Center	5 x 0.99	4"	14"

LIQUID PETROLEUM (LP) GAS

LIQUID PERTROLEUM (LP) GAS NOZZLES

BURNER	POSITION	NOZZLE DIAMETER	MINIMUM PRESSURE	MAXIMUM PRESSURE
Auxiliary	Front Right	1 x 0.70	10"	14"
Semi-Rapid	Rear Left & Right	2 x 0.80	10"	14"
Rapid	Front Left	1 x 0.89	10"	14"
Triple Ring	Center	5 x 0.56	10"	14"

- Contact your local gas supplier if you are not sure about the inlet pressure.

BURNER INPUT REQUIREMENTS:

- Input ratings shown on the model/serial rating plate are for elevations up to 2,000 ft (609.6 m).
- For elevations above 2,000 ft (609.6 m), ratings are reduced at a rate of 4% for each 1,000 ft (304.8 m) above sea level (not applicable for Canada).

GAS SUPPLY PRESSURE TESTING:

Line pressure testing above ½ psi gauge (14" WCP):

- The range and its individual shutoff valve must be disconnected from the gas supply piping system during any pressure testing of that system at test pressures in excess of ½ psi (3.5 kPa).

Line pressure testing at ½ psi gauge (14" WCP) or lower:

- The range must be isolated from the gas supply piping system by closing its individual manual shutoff valve during any pressure testing of the gas supply piping system at test pressures equal to or less than ½ psi (3.5 kPa).

ELECTRICAL REQUIREMENTS

⚠ WARNING



Electrical Shock Hazard

Do not use an extension cord.

Failure to follow these instructions can result in death, fire, or electrical shock.

- ⚠ Any additions, changes or conversions required in order for this appliance to satisfactorily meet the application needs must be made by a qualified service technician in accordance with the manufacturer's instructions and all codes and requirements of the authority having jurisdiction. Failure to follow the instructions could result in serious injury or property damage. The qualified agency performing this work assumes responsibility for the conversion.

- ⚠ This appliance comes supplied with a power cord with a 4-prong plug. If you wish to replace the power cord, it must be installed by a qualified service technician. The plug must be a 4-prong, 3-phase plug that is designed specifically for freestanding ranges.

- ⚠ This appliance can be installed directly to the main (without a plug). To do so, follow

instructions in the "Electrical Connection" section. If you wish to install this appliance directly to the main (without a plug), it must be installed by a qualified service technician.

- ⚠ **DO NOT** operate this appliance using a 2-prong adapter or an extension cord. If a 2-prong wall receptacle is the only available outlet, it is the personal responsibility of the consumer to have it replaced with a properly grounded 4-prong wall receptacle installed by a qualified electrician.

- ⚠ Severe shock, or damage to the range may occur if the range is not installed by a qualified installer or electrician.

- ⚠ This appliance features a pilotless electric ignition for energy savings and reliability. It operates on a **220-240V/50-60Hz - 35 Amp** power supply.

- ⚠ A separate circuit, protected by a 15 amp time delay fuse or circuit breaker, is required.

- ⚠ For personal safety, the appliance must be properly grounded.

- ⚠ See the "Installation Instructions" packaged with this appliance for complete installation and grounding instructions.

ADVANCE PREPARATION

Tools and Parts

Gather the required tools and parts before starting installation.

Read and follow the instructions provided with any tools listed here.

- Tape measure
- Phillips screwdriver
- Flat blade screwdriver
- 1/8" flat blade screwdriver
- Level
- Hand or electric drill
- Wrench or pliers
- Pipe wrench
- 1 5/16" combination wrench
- Marker or pencil
- Pipe-joint compound resistant to LP gas
- 3/16" (4.8 mm) carbide-tipped masonry drill bit (for concrete/ceramic floors)
- Noncorrosive leak-detection solution

FOR LP/NATURAL GAS CONVERSIONS:

- 1/2" Combination wrench
- 1/4" (6 mm) nut driver
- 9/32" (7 mm) nut driver
- Masking tape

PARTS SUPPLIED:

Check that all parts are included.

- 5 - Burner caps
- 3 - Burner grates
- 2 - Oven racks
- 1 - Baking Tray
- 4 adjustable legs / rubber pegs
- Gas Pressure Regulator
- Anti-tip Device (explained on page 21)
- 2 plastic anchors
- 2 screws

The anti-tip device must be securely mounted to the wall.

PARTS NEEDED

Check local codes and consult gas supplier. Check existing gas supply and electrical supply. See "Electrical Requirements" and "Gas Supply Requirements" sections.

RANGE DIMENSIONS

• **⚠** Avoid placing cabinetry directly above the appliance when possible. If cabinetry is used above the cooking surface, use cabinets no more than 13" deep. Make sure the wall coverings, countertop and cabinets around the appliance can withstand heat up to 200° F (93°C) generated by the appliance. (See Figures 1 and 6)

• **⚠** Cabinet opening dimensions that are shown must be used. Given dimensions are minimum clearances. (See Figures 1 and 6)

• **⚠** Working areas adjacent to the range should have 18" minimum clearance between countertop and cabinet bottom. (See Figures 1 and 6)

Figure 6

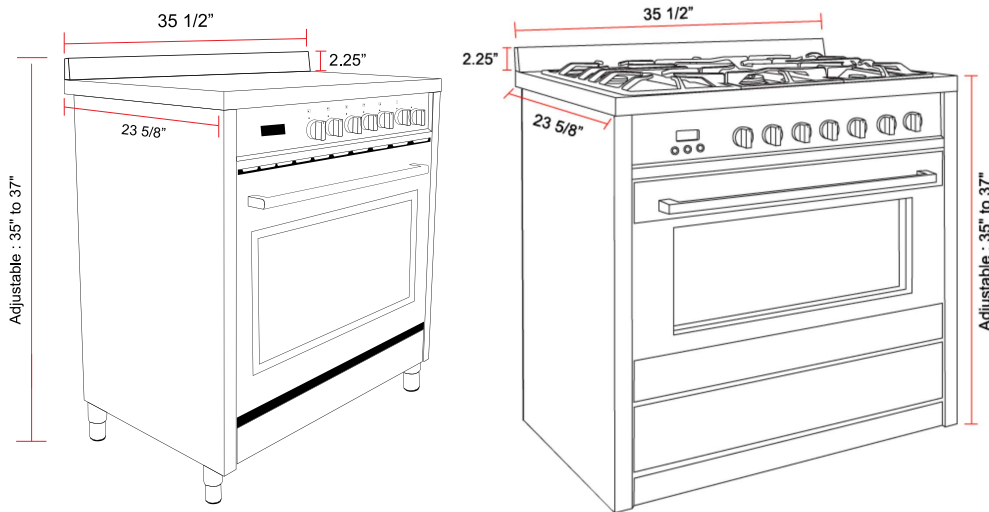

UNPACK RANGE

Install Leveling Feet and Back Panel

⚠ WARNING

Excessive Weight Hazard

Tip Over Hazard

A child or adult can tip the range and be killed.

Use two or more people to move and install range.

Failure to follow these instructions can result in death or serious burns to children and adults.

1. Remove shipping materials from the range. DO NOT remove protective film covering the appliance.
2. Remove oven racks and parts package from inside oven.
3. Place range on its back; take four (4) L-shaped cardboard corners from the carton. Stack one cardboard corner on top of another. Repeat with the other 2 corners.
4. Place the four (4) L-shaped cardboard corners lengthwise on the floor behind the range to support the range when it is laid on its back.
5. Using 2 or more people firmly grasp the range and gently lay it on its back on the cardboard corners.
6. Install the leveling feet one at a time. The leveling feet can be found in one of the boxes that was inside the oven.
7. Place cardboard or hardboard in front of range. Using 2 or more people, stand range back up onto cardboard or hardboard.
8. Remove the protective film covering the appliance.
9. The stainless steel back panel can now be installed. Place panel into the grooves on the top rear of the range. Then affix the panel to the range using the screws provided.

INSTALL ANTI-TIP BRACKET (F965NF ONLY)

⚠ WARNING

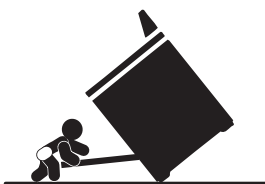

Tip Over Hazard

A child or adult can tip the range and be killed.

Connect anti-tip bracket to rear range foot.

Reconnect the anti-tip bracket, if the range is moved.

Failure to follow these instructions can result in death or serious burns to children and adults.

IMPORTANT:

- An anti-tip bracket is provided with the range. The anti-tip bracket uses a rear range foot to secure the range to the floor or wall.
 - Attach the anti-tip bracket to the floor or wall so that the rear range foot will be centered within the bracket when the range is pushed into its final position.
1. Remove the anti-tip bracket and two screws (provided) from the parts bag.

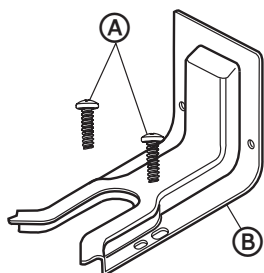

- (A) 16 x 1⁵/₈" Screws (2)
- (B) Anti-tip Bracket

NOTE: The anti-tip bracket must be securely mounted to the subfloor or wall. The flooring's thickness may require longer screws to anchor bracket to subfloor.

2. Place the bracket so that the back of the bracket is against the rear wall and the side edge of the bracket is $\frac{3}{8}$ " to $\frac{1}{2}$ " from the adjacent cabinet.

NOTE: If there is no adjacent cabinet, place the bracket so that the edge of the bracket is $\frac{3}{8}$ " to $\frac{1}{2}$ " in from the range side panel. If the countertop overhangs the cabinet, offset the bracket from the cabinet by the depth of the overhang plus an additional $\frac{3}{8}$ " to $\frac{1}{2}$ ".

3. Using the anti-tip bracket as a template, mark the two holes for either a Floor Wood, Floor Concrete, or Wall installation, as shown.

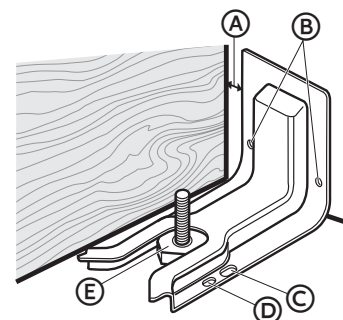

- (A) Distance from Adjacent Cabinet ($\frac{3}{8}$ " to $\frac{1}{2}$ " [0.95 to 1.27 cm])
- (B) Wall Holes
- (C) Concrete Floor Holes
- (D) Wood Floor Holes
- (E) Rear Range Foot

4. Drill two pilot holes where marked. Follow the instructions specific to your construction.

NOTE: A nail or awl may be used to create a pilot hole, if a drill is not available. For concrete construction $\frac{1}{4}$ " x $1\frac{1}{2}$ " Lag Bolts and $\frac{1}{2}$ " O.D. Sleeve Anchors are required.

Wood

- Floor - Drill a $\frac{1}{8}$ " pilot hole, as shown.

NOTE: Contact a qualified floor covering installer for the best procedure for drilling mounting holes through your type of floor covering.

- Wall - Drill an angled $\frac{1}{8}$ " pilot hole, as shown.

Concrete

- Drill the size hole recommended for the anchors into the concrete at the center of the holes identified as Floor Concrete or Wall.

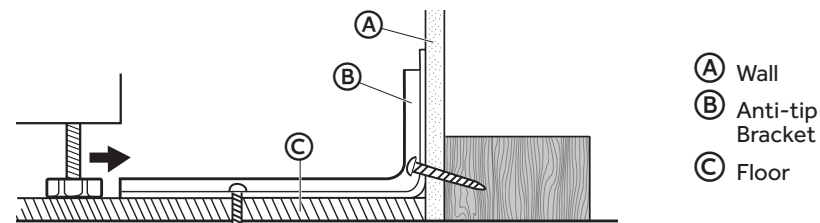

5. Install the anti-tip bracket.

Wood

- Using the two screws (provided) fasten the anti-tip bracket to the floor or wall.

NOTE: The screw must enter wood or metal.

Concrete

- Insert the sleeve anchor into the drilled holes and then insert the lag bolts through the anti-tip bracket and into the floor or wall. The bolts must be properly tightened as recommended for the hardware.

6. Complete the range installation following the Installation Instructions (provided).

INSTALL ANTI-TIP CHAIN (F965 ONLY)

⚠ WARNING



Tip Over Hazard

A child or adult can tip the range and be killed.

Connect anti-tip bracket to rear range foot.

Reconnect the anti-tip bracket, if the range is moved.

Failure to follow these instructions can result in death or serious burns to children and adults.



The range is supplied with an anti-tilting chain to prevent the appliance from tilting forward and accidental damage to the gas pipe. Take the wall anchor with hook and make an adequate hole in the wall behind, at the same height as the chain. Insert the wall anchor into the hole and screw in the hook until it is firmly fixed to the wall. Connect the chain to the hook.

INSTALLATION INSTRUCTIONS

Gas Connection

⚠ WARNING



Explosion Hazard

Use a new CSA International approved gas supply line.

Install a shut-off valve.

Securely tighten all gas connections.

If connected to LP, have a qualified person make sure gas pressure does not exceed 14" (36 cm) water column.

Examples of a qualified person include: licensed heating personnel, authorized gas company personnel, and authorized service personnel.

Failure to do so can result in death, explosion, or fire.

⚠ DANGER

This appliance is outfitted from the factory to be used with ONLY one type of gas. This range is to be connected with gas supply line. The gas connection is a male 1/2" BSP and is located roughly 2 1/4" from the right and 22" from the ground. The hose needs to be free of kinks or other deformation that would inhibit its ability to supply gas to the unit or susceptible to a gas leak. Line should also be free from contact with a moving part such as a drawer, so that it does not become obstructed or damaged.

INSTALLING THE PRESSURE REGULATOR

• This appliance is set for **natural gas** and is designed to operate at 5" water column pressure. The gas supply is required to provide a minimum of 4" to a maximum of 14" water column pressure to the appliance regulator.

NATURAL GAS NOZZLES

BURNER	POSITION	NOZZLE DIAMETER	MINIMUM PRESSURE	MAXIMUM PRESSURE
Auxiliary	Front Right	1 x 1.10	4"	14"
Semi-Rapid	Rear Left & Right	2 x 1.29	4"	14"
Rapid	Front Left	1 x 1.45	4"	14"
Triple Ring	Center	5 x 0.99	4"	14"

• If the appliance is converted for **liquid petroleum (LP) gas**, the LP gas supply is required to provide a minimum of 10" to a maximum of 14" water column to the cooktop regulator.

LIQUID PETROLEUM (LP) GAS NOZZLES

BURNER	POSITION	NOZZLE DIAMETER	MINIMUM PRESSURE	MAXIMUM PRESSURE
Auxiliary	Front Right	1 x 0.70	10"	14"
Semi-Rapid	Rear Left & Right	2 x 0.80	10"	14"
Rapid	Front Left	1 x 0.89	10"	14"
Triple Ring	Center	5 x 0.56	10"	14"

• **⚠** The gas supply line must be equipped with an approved manual shut-off valve. The shut-off valve must be in an easily accessible location in the same room as the appliance. Do not block access to the shutoff valve. Be sure you know how and where to shut off the gas supply to the range.

- 1) The gas inlet is located 6" down from the top of the appliance at the rear on the right side and 2 ½" in from the right hand side of the appliance. Make gas connection through rear wall, or on cabinet floor at rear. Install the house gas supply at least 1" from the back wall.
- 2) When installing, fit a safety valve at the end of the pipeline. The appliance leaves the factory tested and set for natural gas. Make sure that the type of gas to be supplied to the appliance is the same as that shown on the label affixed to the rear of the appliance. (See Figure 12)
- 3) Make the connection to the gas system using a rigid ½" or ¾" metal pipe and regulation unions, or with a stainless steel hose complying with the local standard. If metal hoses are used, take care that they do not come into contact with mobile parts and are not crushed.
- 4) The gas intake connection of the appliance has a "male thread." When making the connection, take care not to apply stresses of any kind to the appliance. Over-tightening may crack the regulator resulting in a gas leak and possible fire or explosion.

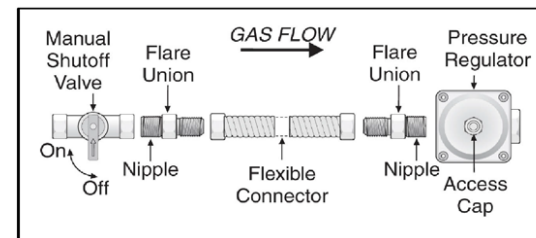

Figure 12

- 5) Once regulator is in place, open the shutoff valve in the gas supply line. Wait a few minutes for gas to move through the gas line.
- 6) After connecting the appliance to the gas supply, make sure all burners knobs are in the OFF position and check the system for leaks with a manometer. If a manometer is not available, turn on the gas supply and use a liquid leak detector (or soap and water) at all joints and connections to check for leaks.

TESTING FOR LEAKS

⚠ DANGER

Do not use a flame to check for leaks from gas connections. Checking for leaks with a flame may result in a fire or explosion.

- **⚠ Tighten all connections** if necessary to prevent gas leakage in the range or supply line.
- **⚠ Check alignment of control knob valves** after connecting the range to the gas supply to be sure the range manifold pipe has not moved. A misalignment could cause the valve stems to rub on the control panel, resulting in a gas leak at the valve.
- **⚠ Disconnect this range and its individual manual shutoff valve** from the gas supply piping system during any pressure testing of that system at test pressures in excess of 1/2 psi (3.5 kPa or 14" water column).

- **⚠ Isolate the range from the gas supply piping system** by closing its individual manual shutoff valve during any pressure testing of the gas supply piping system at test pressures equal to or less than 1/2 psi (3.5 kPa or 14" water column).

ASSEMBLY OF THE BURNERS

The electrode of the electronic ignition system is positioned above the surface of the burner base. Do not remove a burner cap or touch the electrode of a burner while another is turned on. Damage or electrical shock may occur.

1. Place burner heads over the burner base. Make sure the hole in the burner head is properly aligned with the electrode in the burner base. (See Figure 13)
2. Place the burner caps on the burner heads. Make sure that the burner caps are properly seated on the burner head. (See Figure 14)
3. Operation of the electric igniters should be tested after the range and supply line have been carefully checked for leaks and the range has been connected to the electrical power. To check igniters, push and turn a sounds), but only the burner turned to LITE will light.

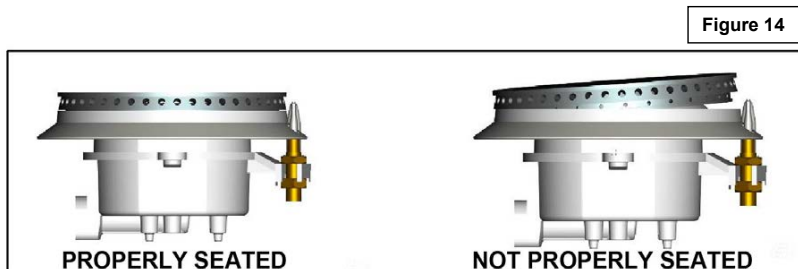
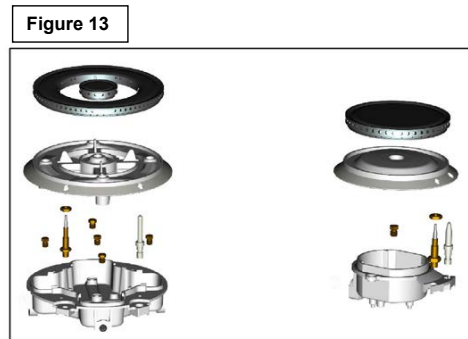

LIQUEFIED PETROLEUM (PROPANE) GAS CONVERSION

⚠ WARNING

Failure to make the appropriate conversion can result in serious personal injury and property damage.

⚠ The conversion must be performed by a qualified service technician in accordance with the kit instructions and all local codes and requirements. Failure to follow instructions could result in serious injury or property damage. The qualified agency performing this work assumes responsibility for the conversion.

This appliance can be used with Natural Gas or LP/Propane Gas. It is shipped from the factory for use with Natural Gas. A kit for converting to LP gas (Not Included) can be purchased from <http://www.cosmoappliances.com>. The kit is marked "Cosmo LP Conversion Kit (Your model number)". If you have trouble locating the correct kit, please contact us.

When the range is converted for Liquid Petroleum (LP) Gas, the LP gas supply is required to provide a minimum of 10" to a maximum of 14" water column to the range regulator.

A. ADJUST THE REGULATOR

- Disconnect all electrical power at the main circuit breaker or fuse box.
- Shut off the gas supply to the appliance by closing the manual shut-off valve.
- Adjust the pressure regulator by doing the following:

- 1) Unscrew the regulator cap with the wrench.
(See Figure 15)



Figure 15

- 2) This is how the retainer pin looks for Natural Gas usage. (See Figure 16)



Figure 16

- 3) Remove the retainer pin. (See Figure 17)

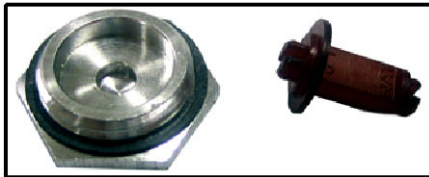

Figure 17

- 4) Reverse the retainer pin and put back into the regulator cap. This is how the regulator pin looks for LP gas usage. (See Figure 18)



Figure 18

- 5) Screw the regulator cap back into the regulator and re-attach the regulator to the nipple and flare union. (See Figures 12 and 19)



Figure 19

B. CHANGE BURNER NOZZLES

INSTALLATION TIP: First remove all nozzles and then start replacing them. This will help to prevent the possibility that some may not be replaced.

- 1) Remove the burner grates, burner caps and burner heads.
- 2) Using a 7mm nut driver, remove the burner nozzles.

Figure 20

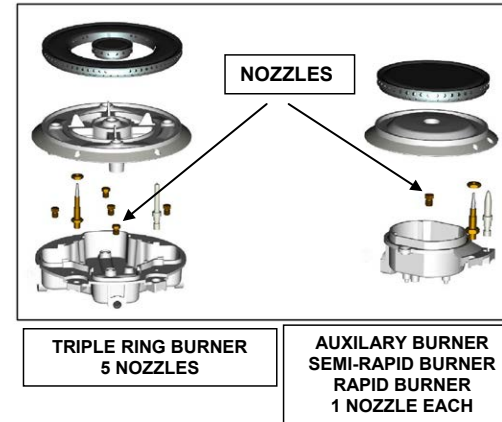
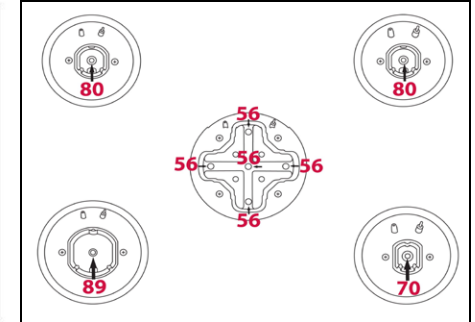

Figure 21



LIQUID PETROLEUM (LP) GAS NOZZLES

BURNER	POSITION	NOZZLE DIAMETER	MINIMUM PRESSURE	MAXIMUM PRESSURE
Auxiliary	Front Right	1 x 0.70	10"	14"
Semi-Rapid	Rear Left & Right	1 x 0.80	10"	14"
Rapid	Front Left	1 x 0.89	10"	14"
Triple Ring	Center	5 x 0.56	10"	14"

IMPORTANT: Carefully read and observe each nozzle label for correct location.

- 3) Install the proper nozzles in the exact locations as noted in the illustrations above and the table below. (See Figures 20, 21 and table above)
- 4) Replace the burner bases, heads, caps and top grates. Make sure burner caps are properly seated on the burner head.

C. ADJUST BURNER FLAMES

- 1) Turn all burners on highest setting and check the flames. They should be blue in color and may have some yellow tipping at the ends of the flame when using LP gas. Foreign particles in the gas line may cause an orange flame at first, but this will soon disappear.
- 2) Turn the range burner knob to "LO" while observing the flame.
- 3) Adjustments must be made with two other burners in operation on a medium setting. This prevents the upper row of flames from being set too low, resulting in the flame being extinguished when other burners are turned on.

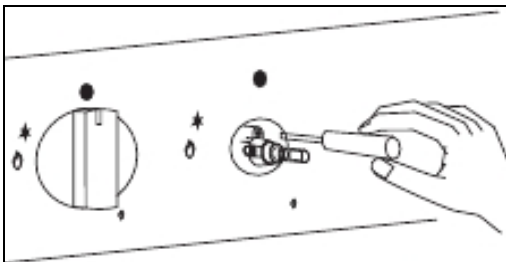

Figure 22

- 4) To adjust the flame, remove the knobs; insert a screwdriver through the access hole in valve shaft as shown. Make the adjustment by slowly turning the screw until flame appearance is correct. (See Figures 22 and 23)
 - If the flames are too small or fluttered, open the valve more than the original setting.
 - If the flames are too large, close the valve more than the original setting.

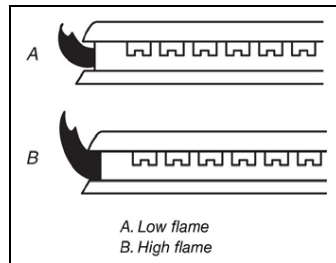

Figure 23

TESTING FLAME STABILITY

Test 1—Turn the knob from "HI" to "LO" quickly. If the upper row of flames goes out at this setting, increase the flame size and test again.

Test 2—With the burner on "LO", open and close the cabinet door under the range. If the flame is extinguished by the air currents created by the door movement, increase the flame height and test again.

D. FLAME RE-CHECK

After the adjustment is made, turn all burners off. Ignite each burner individually. Observe the flame at the "HI" position. Rotate the knob to the lowest setting and be sure that the flame size decreases as the knob is rotated counter-clockwise.

Adjust the height of top burner flames. The range "low" burner flame should be a steady blue flame approximately 1/4" (0.64 cm) high.

⚠ Once the conversion has been completed and has passed testing, fill out the conversion sticker and include your name, organization and the date conversion is made. Apply the sticker near the appliance gas inlet opening to alert others in the future that this appliance has been converted. If converting back to Natural Gas, please remove the sticker so others know that the appliance is set to use its original gas.

ELECTRICAL CONNECTION

⚠ WARNING



Electrical Shock Hazard

Do not use an adapter.

Do not use an extension cord.

Failure to follow these instructions can result in death, fire, or electrical shock.

Electrical connection must be performed by a qualified service technician in accordance with the kit instructions and all local codes and requirements.

- ⚠ If you wish to install this appliance with a plug, it must be installed by a qualified service technician. The plug must be a 4-prong, 3-phase power plug that is designed specifically for ranges and ovens.

Electrical Requirements: 220-240V/50-60Hz, 35 Amps

ELECTRICAL SPECIFICATIONS	
SYSTEM	WATTAGE
Oven Light	2 x 25W
Upper Heating Element	2200W
Bottom Heating Element	1800W
Grill Heating Element	2900W
Convection Heating Element	2 x 1550W
Ventilator Motor	2 x 30W
Cooling Fan	11W

BEFORE MAKING THE ELECTRICAL CONNECTION, MAKE SURE THAT:

⚠ WARNING

- ⚠ The safety circuit-breaker and the electrical system are able to withstand the load of the appliance. See rating label on back of range.
- ⚠ Rating plate is located on back of range should you need to verify any of the electrical requirements.
- ⚠ The power supply system has a ground connection in good working order in accordance with the regulations in force.
- ⚠ The electrical socket is easily accessible with the appliance installed. In all cases, the power supply lead must be positioned so that it does not reach a temperature of 50°C above the room temperature at any point.
- ⚠ The manufacturer is not liable for any direct or indirect damage caused by faulty installation or connection. It is therefore necessary that all installation and connection operations are carried out by qualified personnel complying with the local and general regulations in force.

POWER CORD INSTALLATION INSTRUCTIONS

After reading the requirements for each connection method, follow the electrical connection instructions specific to your situation.

POWER CORD - U.S.A. ONLY

⚠ WARNING



Electrical Shock Hazard

- Disconnect power before servicing.
- Use a new 40 or 50 amp UL listed or CSA certified power supply cord.
- Plug into a grounded outlet.
- Do not use an extension cord.
- Failure to do so can result in death, fire, or electrical shock.

3-WIRE CONNECTION: POWER SUPPLY CORD

IMPORTANT: Use this method only if local codes permit connecting chassis ground conductor to neutral wire of power supply cord.

1. Disconnect power.
2. Remove the entire rear panel from the rear end of the range. Unscrew all of the screws on the panel and set aside to access the electrical terminal block located in the bottom right-hand corner (see below picture).

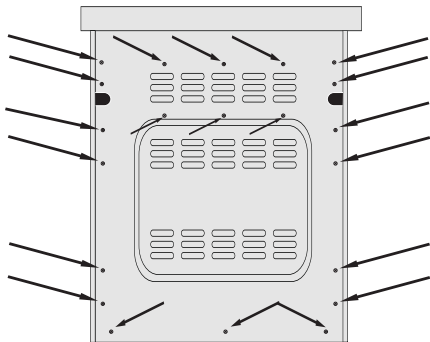

3. Install a UL listed strain relief (not provided) to the power cord opening in the bottom panel, and then completely tighten the nut.

4. Thread the end of the power cord through the strain relief.

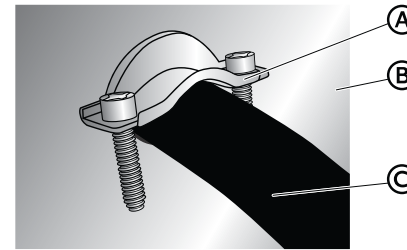

- Ⓐ UL Listed Strain Relief
- Ⓑ Bottom panel
- Ⓒ Power Cord

NOTE: Allow enough slack to connect the wires to the terminal block.

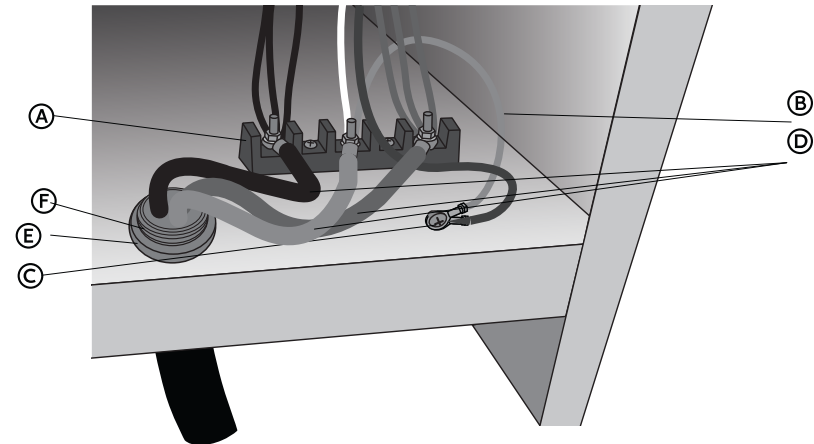

- Ⓐ Terminal Block
- Ⓑ Jumper Wire
- Ⓒ Ground Screw
- Ⓓ Power Cord Wires
- Ⓔ Strain Relief Nut
- Ⓕ UL Listed Strain Relief

5. Using the 10-32 hex nut provided, connect the ground (green) wire from the power cord to the middle post of the terminal block with the white wire from the range.
6. Using 10-32 hex nuts, connect the red and black wires from the power cord to the outer posts of the terminal block with the corresponding red and black wires from the range.
7. Tighten the hex nuts completely, and then verify the connection.

NOTE: For power supply cord replacement, use only a power cord rated at 250 volts minimum, 40- or 50-amps that is marked for use with nominal 1 3/8" (3.5 cm) diameter connection opening, with ring terminals and marked for use with ranges.

8. Gently, pull the excess power cord to the outside.

- Verify the strain relief is tightened securely to the outer layer of insulation of the power cord by positioning the power cord appropriately and tightening the screws.

NOTE: Before tightening, make sure the strain relief is positioned over the cord and NOT the wires.

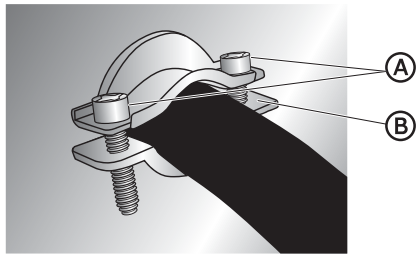

- (A) Strain Relief Screws
- (B) Lower Part of Strain Relief

- Align the rear panel to the rear of the range and secure with all screws.
- Plug range into grounded outlet.
- Tuck excess power cord under the range.

4-WIRE CONNECTION: POWER SUPPLY CORD

IMPORTANT: Use this method for new branch-circuit installations (1996 NEC), mobile homes, recreational vehicles, or in an area where local codes prohibit grounding through the neutral.

- Disconnect power.
- Remove the entire rear panel from the rear end of the range. Unscrew all of the screws on the panel and set aside to access the electrical terminal block located in the bottom right-hand corner (see below picture).

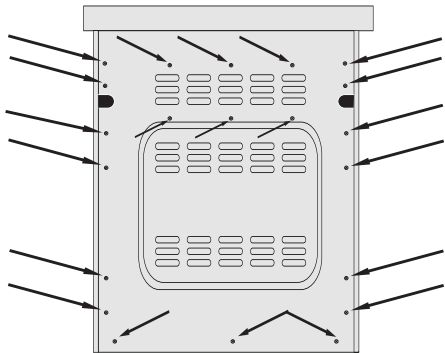

- Install a UL listed strain relief (not provided) to the power cord opening in the bottom panel, and then completely tighten the nut.

- Thread the end of the power cord through the strain relief.

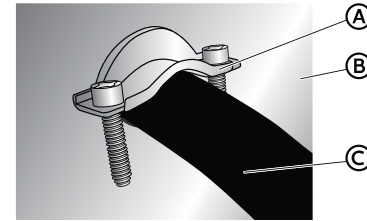

- (A) UL Listed Strain Relief
- (B) Bottom panel
- (C) Power Cord

NOTE: Allow enough slack to connect the wires to the terminal block.

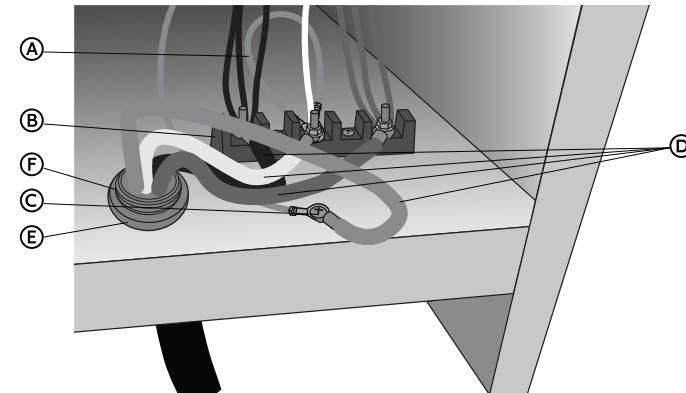

- (A) Jumper Wire
- (B) Terminal Block
- (C) Ground Screw
- (D) Power Cord Wires
- (E) Strain Relief Nut
- (F) UL Listed Strain Relief

- Remove the green jumper wire from under the ground screw. Loop the green jumper wire removed from the ground screw back onto its end that is fastened to the center post of the terminal block.
- Use 3/8" (1.0cm) nut driver to connect the neutral (white) wire and the two ends of the jumper (green) wire to the center terminal block post with one of the 10-32 hex nuts.
- Insert the ground screw through the ground (green) wire from the power cord and the remaining ground (green) wire from the range. Tighten the screw, making sure the terminals are unable to rotate under the screw head.
- Using 10-32 hex nuts, connect the red and black wires from the power cord to the outer posts of the terminal block with the corresponding red and black wires from the range.
- Tighten the hex nuts completely, and then verify the connection.
- Gently, pull the excess power cord to the outside.
- Verify the strain relief is tightened securely to the outer layer of insulation of the power cord by positioning the power cord appropriately and tightening the screws.

NOTE: For power supply cord replacement, use only a power cord rated at 250 volts minimum, 40- or 50-amps that is marked for use with nominal 1 3/8" (3.5 cm) diameter connection opening, with ring terminals and marked for use with ranges.

12. Align the rear panel to the rear of the range and secure with all screws.
13. Position the lower part of the strain relief under the power cord and tighten the strain relief screws.

NOTE: Before tightening, make sure the strain relief is positioned over the cord and NOT the wires.

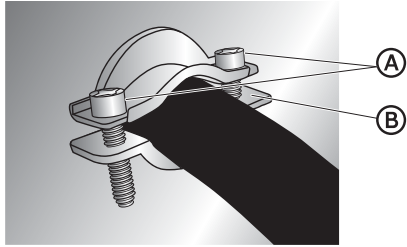

- (A) Strain Relief Screws
- (B) Lower Part of Strain Relief

14. Position rear panel against the back of the range and tighten the screws.
15. Plug range into grounded outlet.
16. Tuck excess power cord under the range.

POWER CORD - CANADA ONLY

⚠ WARNING



Electrical Shock Hazard

Plug into a grounded outlet.
Do not use an extension cord.
Failure to do so can result in death, fire, or electrical shock.

1. Plug into a standard 14-50R grounded wall receptacle.

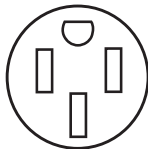

2. Go to STEP 4 - INSTALL RANGE.

USING THE COOKTOP

Flame Size

- **For most cooking**, start on the highest control setting and then turn to a lower one to complete the process. The size and type of utensil used and the amount of food being cooked will influence the setting needed for cooking.

- **For deep fat frying**, use a thermometer and adjust the surface control knob accordingly. If the fat is too cool, the food will absorb the fat and be greasy. If the fat is too hot, the food will brown so quickly that the center will be undercooked. Do not attempt to deep fry too much food at once as the food will neither brown nor cook properly.

- **⚠** Never extend the flame beyond the outer edge of the utensil. A higher flame simply wastes heat and energy, and increases your risk of being burned by the flame. (See Figure 25)

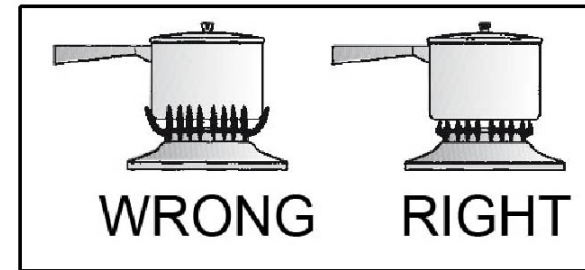

Figure 25

Proper Burner Adjustments

- The color of the flame is the key to proper burner adjustment. A good flame is clear, blue and hardly visible in a well-lighted room. Each cone of flame should be steady and sharply defined.

- Adjust or clean burner if flame is yellow-orange. To clean burners, see instructions under "Care and Cleaning". (See Figures 22 and 23)

Location of the Burners

1. Auxiliary burner (Front right) - 5,000 BTU
2. Rapid burner (Front left) – 8,500 BTU
3. Semi-rapid burners (Rear left and right) – 7,000 BTU
4. Triple-ring burner – (Center) 18,000 BTU

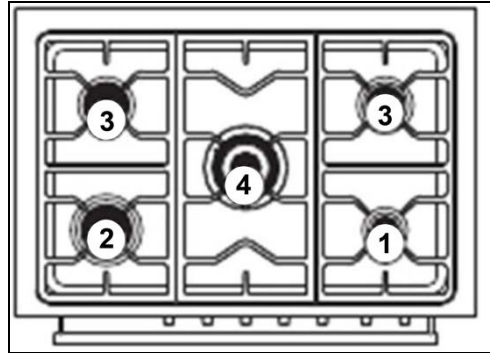

Figure 26

Placement of Burner Heads and Caps

- 1) Place a burner cap on each burner head, matching the cap size to the head size. The cap for each burner has an inner locating ring which centers the cap correctly on the burner head. Be sure that all the burner caps and burner heads are correctly placed BEFORE using your appliance. (See Figure 27)

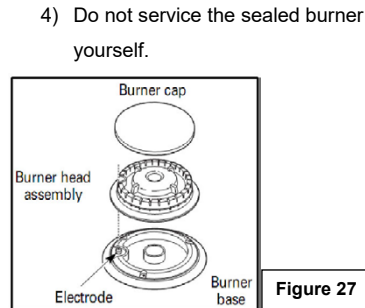

Figure 27

- 2) Make sure each burner cap is properly aligned and level. (See Figure 28)
- 3) Turn the burner on to determine if it will light. If the burner does not light, contact a qualified service center.

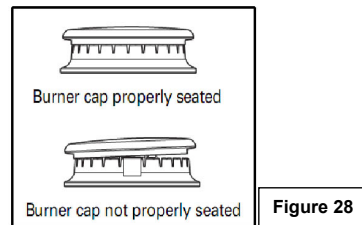

Figure 28

Cooktop Using Pots and Pans

⚠ Do not place plastic items such as salt and pepper shakers, spoon holders or plastic wrappings on top of the appliance when it is in use. These items could melt or ignite. Potholders, towels or wood spoons could catch fire if placed too close to a flame.

⚠ Note: Always use a utensil for its intended purpose. Follow manufacturer's instructions. Some utensils were not made to be used in the oven or on the cooking surface.

Regardless of size, always select a utensil that is suitable for the amount and type of food being prepared. Select a burner and flame size appropriate to the pan. Never allow flames to extend beyond the outer edge of the pan.

For lower gas consumption and better efficiency: Use **only flat-bottomed** pans of dimensions suitable for the burners, as shown in the table below. Check for flatness by rotating a ruler across the bottom of the pan. There should be no gaps between the pan and ruler. As soon as a liquid comes to a boil take care to turn the flame down to a level that will just keep it simmering. (See Figure 29)

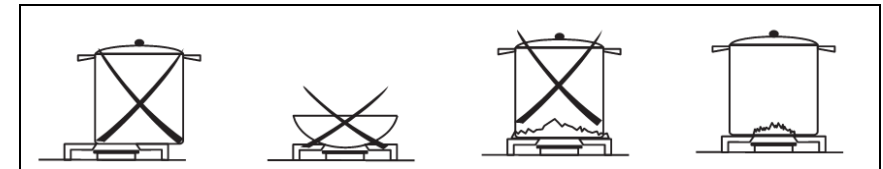

Figure 29

Specialty pans (lobster pots and pressure cookers) may be used but must conform to the recommended cookware requirements.

⚠ During cooking processes involving fats or oils, watch your foods carefully because these substances may catch fire if brought to high temperatures.

BURNER	MINIMUM DIAMETER OF PAN	MAXIMUM DIAMETER OF PAN
Rapid (front left)	178 mm (7 inches)	254 mm (10 inches)
Semi-Rapid (rear left and right)	152 mm (6 inches)	203 mm (8 inches)
Auxiliary (front right)	76 mm (3 inches)	178 mm (7 inches)
Triple-Ring (center)	203 mm (8 inches)	330 mm (13 inches)

Setting Cooktop Controls

SYMBOLS

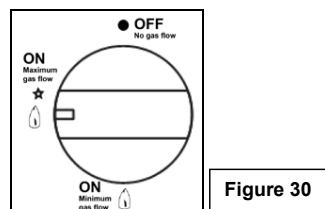
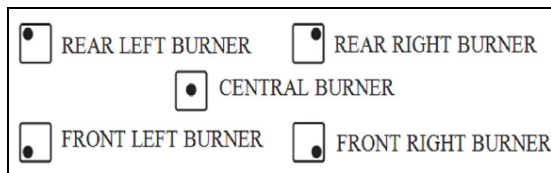





Figure 30

IGNITION AND OPERATION OF THE GAS BURNERS

- To obtain a flame more easily, light the burner before placing a cooking utensil on the burner grate.
- To light a burner, press the knob of the burner fully down and turn it counter-clockwise to the "maximum flow" setting symbol:  . (See Figure 30)
- After lighting the flame, keep the knob pressed down for about 10 seconds. This is necessary to heat up the thermocouple and activate the safety valve, which would otherwise cut off the gas flow.
- Check that the flame is even and turn the control knob to adjust the flame as required: . (See Figure 30)
- If the burner fails to ignite, wait one minute for the gas to dissipate before attempting to reignite. At this moment it is possible to adjust the flame intensity by rotating the knob counter-clockwise to the desired position.
- In the instance of a power outage, place a lit match near the burner and proceed as already described. If the burner does not light after a few attempts, check that the "burner cap" and "flame cap" are correctly positioned.
- To turn off the flame, turn the control knob clockwise to the:  symbol. Always lower or turn off the flame before removing pans from the burners. (See Figure 30)

⚠ ALWAYS USE CAUTION WHEN LIGHTING BURNERS MANUALLY. ⚠

OVEN COOKING

Setting Oven Clock and Timer

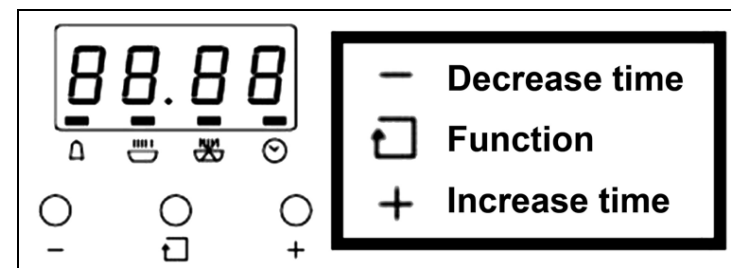



Figure 31

DIGITAL CLOCK

This model has a digital display 24 hour clock with 3 control buttons. When first connected to power (or after a power outage) the screen will display '12:00' and the bar above the  symbol will flash. (See Figure 31)

ADJUSTING THE CLOCK



To set the correct time, press the + or – button to advance forward or backward until the correct time is displayed. When finished you can press the function button, otherwise wait 5 seconds it will stay at the set time. (See Figure 31)

MANUAL OPERATION

Press the function button to select manual operation.

COOKING WITH THE TIMER

By selecting the desired end time, cooking time, temperature and cooking mode you can set the oven to cook your dish automatically. (See Figure 31)

- Press the function button until the bar above the  symbol flashes, then press + or – to set the cooking time.
- Press the function button until the bar above the  symbol flashes, then press + or – to set the desired end time.
- Set the temperature and cooking mode using the thermostat and selector knobs.

Setting Oven Controls

KNOB SETTINGS

New knob design now features oven controls directly on the knob. Simply twist to desired setting to set that cooking mode. (see below for modes)

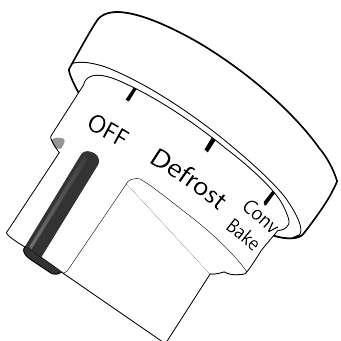

Figure 32

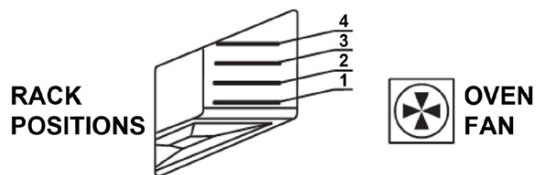

Figure 33

Selection of cooking temperature is carried out by turning the knob clockwise to the required temperature. The warning light will illuminate during the heating process. Once the oven reaches desired temperature, the light will go out. Regular flashing means that the oven temperature is being maintained at the programmed level.

DEFROST (Bottom fan)

All types of food can be defrosted by circulating air at room temperature: cakes, cream, fruit, etc. For foods such as: meat, fish, and bread you will want to set the fan temperature to 175-200° C (347-392° F).

CONVECTION BAKE (Cooking element & Fan)

THERMOSTAT SELECTOR SWITCH FROM 60° C (140° F) TO MAX

This method allows even-heat multi-rack cooking for various types of foods with the appropriate cooking times for each dish. The oven must be preheated before the foods are placed inside.

Use the 'Fan Forced' function to operate.

CONVECTION BROIL (Grill element and Fan)

THERMOSTAT SELECTOR SWITCH FROM 60° C (140° F) TO 200° C (392° F)

Best used for grilling meats, vegetables, and poultry. Preheat the oven, place food on a grilling rack or backing tray and place in the middle of the oven. Other racks can be used simultaneously using this method.

HIGH BROIL (Grill Element)

THERMOSTAT SELECTOR SWITCH FROM 60° C (140° F) TO MAX

The use of the grill element is best reserved for: melting cheese, toasting, and browning. The cooking time should be no longer than 5 minutes. To operate, please select Full Grill Function along with the temperature.

LOW BROIL (UPPER ELEMENT COOKING)

THERMOSTAT SELECTOR SWITCH FROM 60° C (140° F) TO MAX

This is best used to brown select dishes at the end of cooking.

PIZZA (Lower element and Fan)

THERMOSTAT SELECTOR SWITCH FROM 60° C (140° F) TO MAX

Ideal for pastries and cakes with wet covering and little sugar and damp desserts in moulds. Excellent results can also be achieved in completing cooking at the bottom and with dishes requiring heat in the lower area in particular. The plate is best inserted at bottom level.

BAKE (Upper and Lower element)

THERMOSTAT SELECTOR SWITCH FROM 60° C (140° F) TO MAX

The heat is provided from the top and bottom elements. The oven must be preheated before the food is placed inside. Static cooking provides optimum results with: cakes, pizzas, bread and for gentle slow cooking of casseroles. Characteristics of static cooking: heat provided from above and below, cooking is possible only on middle shelf and should be centrally located in the oven.

LIGHT - LIGHT INDICATOR

The lamp of the oven is on. During oven operation the lamp will always remain on.



Cooking Instructions

Setting:	Food:	Rack Level (See Figure 33)	Temperature (Fahrenheit):	Time (mins):
Traditional Cooking (add time for preheat)	Lasagna	2-3	410-450	30
	Oven-Baked Pasta	2-3	410-450	40
	Roast Veal	2	350-400	30-40/lb
	Beef	2	410-460	30-40/lb
	Pork	2	340-400	30-40/lb
	Chicken	2	340-400	45-60
	Duck	2	340-400	45-60
	Goose/Turkey	1	280-340	45-60
	Lamb	2	340-400	15/lb
	Fish	1-2	340-400	Depends on dimension
	Pizza	1-2	410-450	40-45
	Short Pastry	1-2	340-400	15-20
	Fruit Cake	1-2	340-400	20-30
	Browning	3-4	140	5
Convection Cooking (add time for preheat)	Lasagna	2-3	375-410	20-25
	Oven-Baked Pasta	2	375-410	25-30
	Roast Veal	2	300-350	65-90
	Beef	2	350-375	65-90
	Pork	2	300-325	70-100
	Chicken	2	350	70-90
	Duck	2	325-350	100-160
	Goose/Turkey	2	300-325	160-240
	Lamb	2	300-350	100-130
	Fish	2-3	300-350	Depends on dimension
	Pizza	2-3	410-475	30-50
	Sponge Cake	2-3	375-425	25-35
	Fruit Cake	2-3	350-375	40-50
	Bread	1-2	425-475	7
Setting:	Food:	Rack Level (See Figure 33)	1st Side Cook Time (mins):	2nd Side Cook Time (mins):
Grill Cooking	Pork Chops	4	7-9	5-7
	Fillet (Pork)	3	9-11	5-9
	Fillet (Beef)	3	9-11	9-11
	Liver	4	2-3	2-3
	Veal	4	7-9	5-7
	Chicken	3	9-14	9-11
	Sausages	4	7-9	5-6
	Meatballs	4	7-9	5-6
	Fish Fillet	4	5-6	3-4
	Toast	4	2-4	2-3

CARE AND CLEANING

⚠ WARNING



ELECTRICAL SHOCK HAZARD

⚠ DANGER

BURN HAZARD

To avoid possible burns use care when cleaning the appliance.

DO NOT attempt to clean the appliance whenever the oven or burner heads are still hot.

To avoid possible burns **DO NOT** attempt any of the following cleaning instructions before turning OFF ALL of the surface burners and allowing them to cool.

IMPORTANT: Always follow label instructions on cleaning products.

• Control Knobs

- For general cleaning, use hot, soapy water and a cloth.
- For more difficult soils and built-up grease, apply a liquid detergent directly onto the soil. Rinse with a damp cloth and dry.
- **DO NOT** use steel wool or acidic cleaners on the knobs as they can scratch.

• Burner Grates

- Clean burner grates in the dishwasher and dry upon removal.
- Please note that the grates are equipped with rubber pads on the feet that come into contact with the range to avoid scratches. After cleaning it is important to verify that these rubber pads are still there. Should they come off, they can be reapplied using heat resistant adhesive.
- Grates should be positioned correctly over the burners as shown. (See Figure 34)

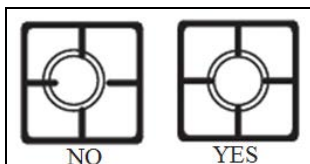

Figure 34

• Burner Caps

- To clean the burner caps, lift the burner cap off the burner head. Clean heavy soils with an absorbent cloth.
- Rinse with a clean, damp cloth and immediately **thoroughly** dry including the bottom and inside of the cap.
- Do not use harsh abrasive cleaners. They can scratch the cap.
- **DO NOT PUT BURNER UNITS IN THE DISHWASHER**

• Burner Heads

- The holes in the burners of your appliance **MUST** be kept clean at all times for proper ignition and a complete, even flame. Remove any food from between the burner slots using a small nonabrasive brush like a toothbrush and afterwards wipe using a damp cloth.
- To remove deposits from the burner cavities, remove the cap and separate the two parts. Clean the burner holes routinely with a small gauge wire or needle and especially after bad spillovers which could clog these holes.
- After cleaning, put the two parts back together and return them correctly to their position, making sure they are seated and level.
- **DO NOT PUT BURNER UNITS IN THE DISHWASHER**

• Stainless Steel

- Clean stainless steel with hot, soapy water and a dishcloth. Rinse with clean water and a cloth.
- Do not use cleaners with high concentrations of chlorides or chlorines. Do not use harsh scrubbing cleaners. Only use kitchen cleaners that are especially made for cleaning stainless steel.

• Inside Oven

- This appliance does **NOT** have a self-cleaning feature.
- **DO NOT** attempt to clean the appliance whenever the oven is still hot.
- Use an appropriate cleaning product designed specifically to clean the inside of ovens.
- **IMPORTANT:** Always follow label instructions on cleaning products.

• Cleaning Interior Lower Grill Element

- To remove the element, support one side with your hand while removing the retainer with the other.
- When cleaning, make sure not to apply excessive force on the element as it is fragile.
- Reposition the element and secure the retainer back in place.
- DO NOT use the oven with the grill element hanging down – it must be repositioned after cleaning.

• Oven Door Exterior

- Use a glass cleaner and a soft cloth or sponge.
- Apply glass cleaner to soft cloth or sponge, not directly on panel.

• Removing and Cleaning the Oven Door

For normal range use, it is not suggested to remove the oven door. However, if removal is necessary, make sure the oven is off and cool. The oven door is heavy. Follow these instructions.

- Open the door fully.
 - Lift up and turn the small levers located on the two hinges.
 - While holding the door on each side, close it approximately half way.
 - While in this position release the door by pressing clamps 'F' (see illustration below) and pull the door towards you. (See Figure 35)
- To replace the door, perform the reverse of the above procedure.

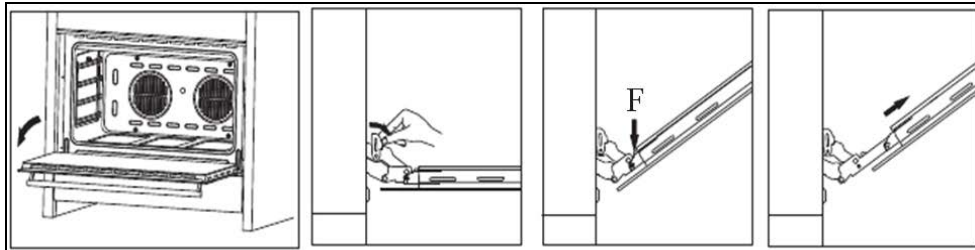

Figure 35

• Changing the Interior Oven Light Bulb

⚠ WARNING



ELECTRICAL SHOCK HAZARD

- Ensure that the appliance is switched off before replacing the lamp to avoid possible electric shock.
- Remove the glass cover by turning counter clockwise. (See Figure 36)
- Replace bulb with a high temperature bulb able to withstand 600 degrees and that meets the following criteria:
 - 240V
 - 25W
 - Type: E-14

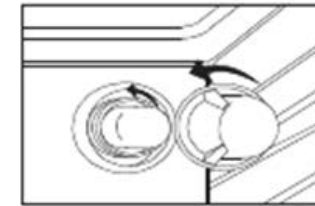

Figure 36

SOLUTIONS TO COMMON PROBLEMS

IMPORTANT

Before calling for service, review this list. It may save you both time and expense. This list includes common experiences that are not the result of defective workmanship or material in your appliance.

⚠ WARNING

Electrical Shock Hazard

Plug into a grounded 4 prong outlet.

Do not remove ground prong.

Do not use an adapter.

Do not use an extension cord.

Failure to follow these instructions can result in death, fire, or electrical shock.

NOTHING WILL OPERATE

■ Is the electrical supply disconnected?

Verify that electrical wires are connected to the mains properly. See “Electrical Connection” section. If the problem continues, contact a qualified technician.

■ Household fuse blown or circuit breaker tripped?

Replace the fuse or reset the circuit breaker. If the problem continues, contact a qualified technician.

■ Is the main or regulator gas shutoff valve in the off position?

See “Gas Connection” section.

■ Is the range properly connected to the gas supply?

Contact a qualified technician. See “Gas Connection” section.

SURFACE BURNERS WILL NOT OPERATE

■ Is this the first time the surface burners have been used?

Turn on any one of the surface burner knobs to release air from the gas lines.

■ Is the control knob set correctly?

Push in knob before turning to a setting.

■ Are the burner ports clogged?

See “Care and Cleaning” section.

SURFACE BURNERS ARE UNEVEN, YELLOW AND/OR NOISY

■ Are the burner ports clogged?

See “Care and Cleaning” section.

■ Are the burner caps positioned properly?

See “Placement of Burner Heads and Caps” section.

■ Is propane gas being used?

The range may have been converted improperly. Contact a qualified service technician. See “Liquid Petroleum (Propane) Gas Conversion” section.

SURFACE BURNER MAKES POPPING NOISES

■ Is the burner wet?

Let it dry.

EXCESS HEAT AROUND COOKWARE ON COOKING SURFACE

■ Is the cookware the proper size?

Use cookware about the same size as the surface cooking area, element or surface burner. Cookware should not extend more than ½" (1.3 cm) outside the cooking area.

COOKTOP COOKING RESULTS NOT WHAT EXPECTED

■ Is the proper cookware being used?

See “Surface Cooking Utensils” section.

■ Is the control knob set to the proper heat level?

See “Setting Surface Controls” section.

■ Is the range level?

Level the range. See the “Unpack Range / Install Leveling Feet and Back Panel” section.

OVEN WILL NOT OPERATE

■ Are the oven controls set correctly?

See “Setting Oven Controls” section.

COOLING FAN RUNS DURING BAKING AND BROILING

- It is normal for the fan to automatically run while the oven is in use and for some time after to cool.

OVEN TEMPERATURE TOO HIGH OR TOO LOW

■ Was the oven preheated?

See "Cooking Instructions" section.

■ Are the racks positioned properly?

See "Cooking Instructions" section.

■ Is there proper air circulation around bakeware?

See "Cooking Instructions" section.

■ Is the batter evenly distributed in the pan?

Check that batter is level in the pan.

■ Is the proper length of time being used?

Adjust cooking time.

■ Has the oven door been opened while cooking?

Oven peeking releases oven heat and can result in longer cooking times.

■ Are baked items too brown on the bottom?

Move rack to higher position in the oven.

■ Are pie crust edges browning early?

Use aluminum foil to cover the edge of the crust and/or reduce baking temperature.

NO SPARK WHEN LIGHTING BURNER

■ Electrical supply - The electrical wires or the plug are not connected well.

Connect with electrical power again. If the problem continues, contact a qualified technician.

■ Burner - The burner is not installed correctly.

Install the burner again. See "Placement of Burners and Caps" section.

■ Spark pin - Ignition electrode and the hole are not placed well.

Install the burner again. See "Placement of Burners and Caps" section.

THE FIRE GOES OUT ONCE RELEASING THE KNOB

■ Safety valve - Knob not pressed down long enough.

Press and turn the knob again and keep 3 to 5 seconds after the burner has been lit.

BURNER WON'T IGNITE OR BURNS UNEVENLY

■ Gas valve - The valve is not open.

Make sure the valve is completely open.

■ Gas pipe - There may be air in the gas pipe.

Ignite repeatedly until flame catches.

■ Burner cap

– The burner cap is not placed correctly.

- Replace the burner cap.

– Some holes in the lid are stocked.

- Clean the holes of the lid.

■ Spark pin - The spark pin is wet or contaminated by the food.

Clean and dry the spark pin..

■ Gas connecting pipes - The gas connecting pipes are stocked or squashed.

Contact a qualified technician. Adjust or change the connecting pipes.

THE FLAME GOES OUT DURING OPERATION

■ Thermocouple

– The safety device is contaminated.

- Clean the thermocouple.

– The flame is so little that it can't touch the thermocouple

- Adjust the flame a little bigger. See the "Proper Burner Adjustments" section.

STRANGE SMELL

■ Gas leaking - Contact a qualified technician

– The gas supply pipe is old and broken.

- The main burner is not lit.

– Change the gas supply pipe.

- Ignite again after there is no strange smell.



APPLIANCES

WARRANTY AND SERVICE

For full warranty details on this product please visit:
<http://www.cosmoappliances.com/warranty>

TO RECEIVE WARRANTY SERVICE, YOUR
PRODUCT MUST BE REGISTERED. TO REGISTER, VISIT:

WWW.COSMOAPPLIANCES.COM/WARRANTY

SCAN TO REGISTER



IMPORTANT

Do Not Return This Product To The Store If
you have a problem with this product, please contact

Cosmo Customer Support at

+1(888)784-3108

DATED PROOF OF PURCHASE, MODEL #, AND SERIAL #
REQUIRED FOR WARRANTY SERVICE

IMPORTANT

Ne pas Réexpédier ce Produit au Magasin
Pour tout problème concernant ce produit, veuillez contacter
le service des consommateurs Cosmo Customer Support au

+1(888) 784-3108

UNE PREUVE D'ACHAT DATEE EST REQUISE POUR BENEFICIER DE
LA GARANTIE.

IMPORTANTE

No regrese este producto a la tienda
Si tiene algún problema con este producto, por favor contacte el
AYUDA AL CLIENTE COSMO al

+1(888)784-3108

(Válido solo en E.U.A).

NECESITA UNA PRUEBA DE DE COMPRA FECHADA, NÚMERO DE
MODELO Y DE SERIE PARA EL SERVICIO DE LA GARANTÍA

Correct Disposal of this product:

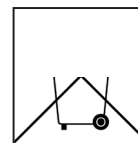

This marking indicates that this appliance should not
be disposed with other household wastes. To prevent
possible harm to the environment or human health
from uncontrolled waste disposal, recycle it responsibly to
promote the sustainable reuse of material resources.



Cosmo is constantly making efforts to improve the quality and performance of our products, so we may make changes to our appliances without updating this manual.

Electronic version of this manual is available at:
www.cosmoappliances.com