

HOME DECORATORS COLLECTION

Item #BF-20191

USE AND CARE GUIDE

HAMPTON HARBOR 25 IN. W X 14 IN. D X

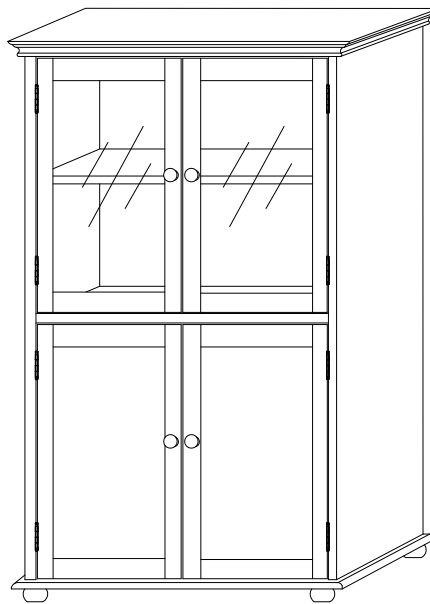

Questions, problems, missing part? Before returning to the store,
call Home Decorators Collection Customer Service
8 a.m.-7p.m., EST, Monday-Friday, 9 a.m.- p.m., EST, Saturday

1-800-986-3460

HOMEDEPOT.COM/HOMEDECORATORS

THANK YOU

We appreciate the trust and confidence you have placed in Home Decorators Collection through the purchase of this product. We strive to continually create quality products designed to enhance your home. Visit us see our full line of products available for your home improvement needs. Thank you for choosing Home Decorators Collection!

Table of Contents

Table of Contents	2	Installation	4-5
Safety Information	2	Maintenance	6
Warranty	2	Care and Cleaning	6
Pre-Installation	3	IMPORTANT HEALTH NOTICE	6
Planning Installation	3		
Dimensions	3		
Tools Required	3		
Package Contents	3		

Safety Information

- Read and understand these instructions before attempting to install or use this product.



CAUTION : Use caution when lifting heavy objects. Lifting heavy objects improperly could cause serious injury. At least need 4 people to carry the product.



NOTE : Handle with care. Do not drop or handle roughly, as this could damage the product.

Warranty

This product comes with a manufacture Limited Lifetime Warranty. The warranty applies to the original purchaser of the product and guarantees that the surface will not wear through or peel off. Installation of the product confirms your acceptance of the product. Failure to follow Pre-Installation and Installation guidelines will void the warranty. The warranty does not cover damage from improper use, care or maintenance, including scratching, exposure to moisture and humidity, water damage, denting, fading, or staining.

Contact the Customer Service Team at 1-800-986-3460 or visit www.HOMEDEPOT.com/HOMEDECORATORS.

Pre-Installation

PLANNING INSTALLATION

Check the product for damage before installation. If any part of the product is missing or damaged, contact the Customer Service Team at 1-800-986-3460.

DIMENSIONS

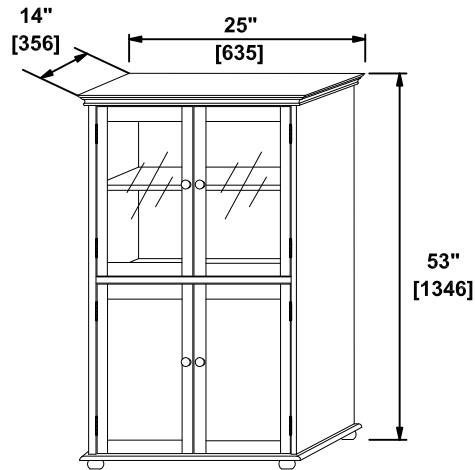

TOOLS REQUIRED



Safety goggles



Electric screwdriver



Level

PACKAGE CONTENTS

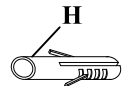
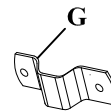
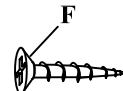
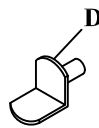
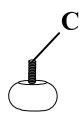
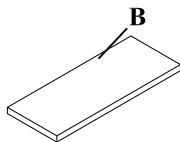

Part	Description	Quantity
A	Main body	1
B	Shelves	2
C	FEET	4
D	Shelf supports	8

Part	Description	Quantity
E	Plastic belts	2
F	Screws	4
G	Hook	2
H	Geckos	4

Installation

1 Assembly feet

- Insert 4 supporting feet (C) In the main body (A).

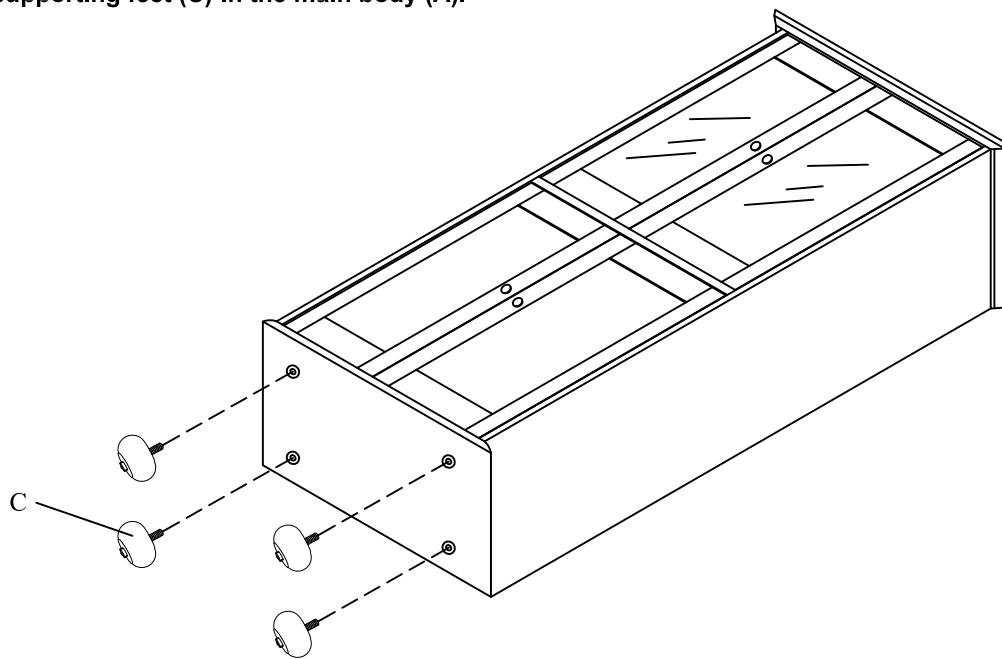

2 Assemble the shelf supports

- Insert the 8 shelf supports (D) into holes in the main body (A).

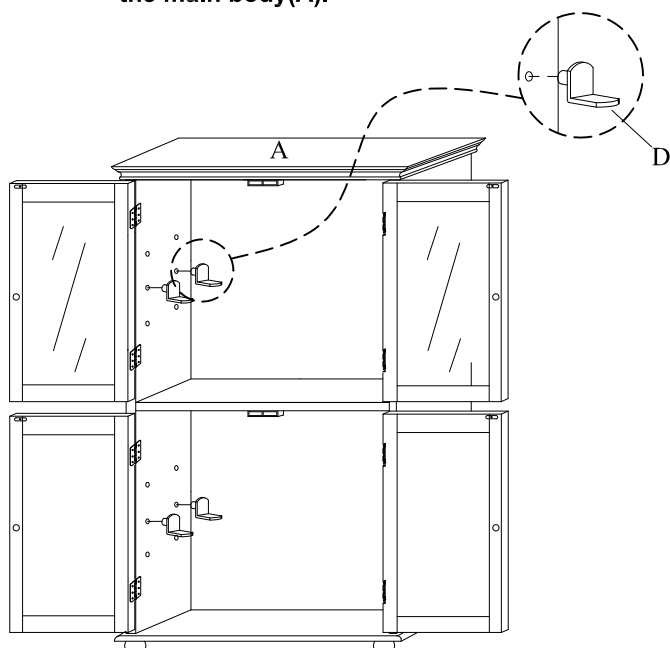

3 Assemble the shelves

- Finally, put the 2 shelves (B) onto the shelf supports (C).

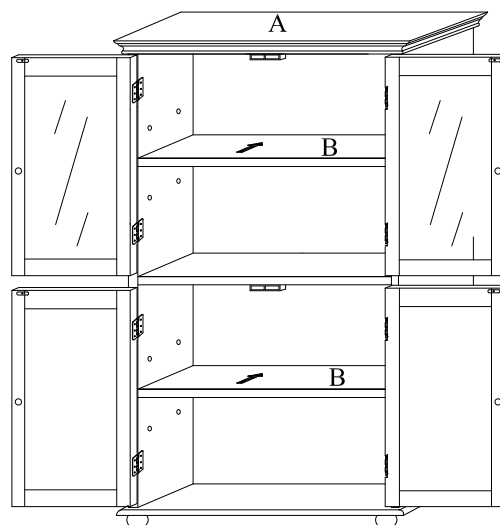

Installation

4 Assemble anti-tip hardware.

- Drill 4 holes in the wall, see hook (G) and harvest top
The pitch and height of the panel.
- Insert 4 anchor points (H) into the holes in the wall.
- Fit the two hooks (G) into the holes in the wall, then
Screw the 4 screws (F) into the anchor (H).
- Connect the two hooks (G) with a plastic belt (E).

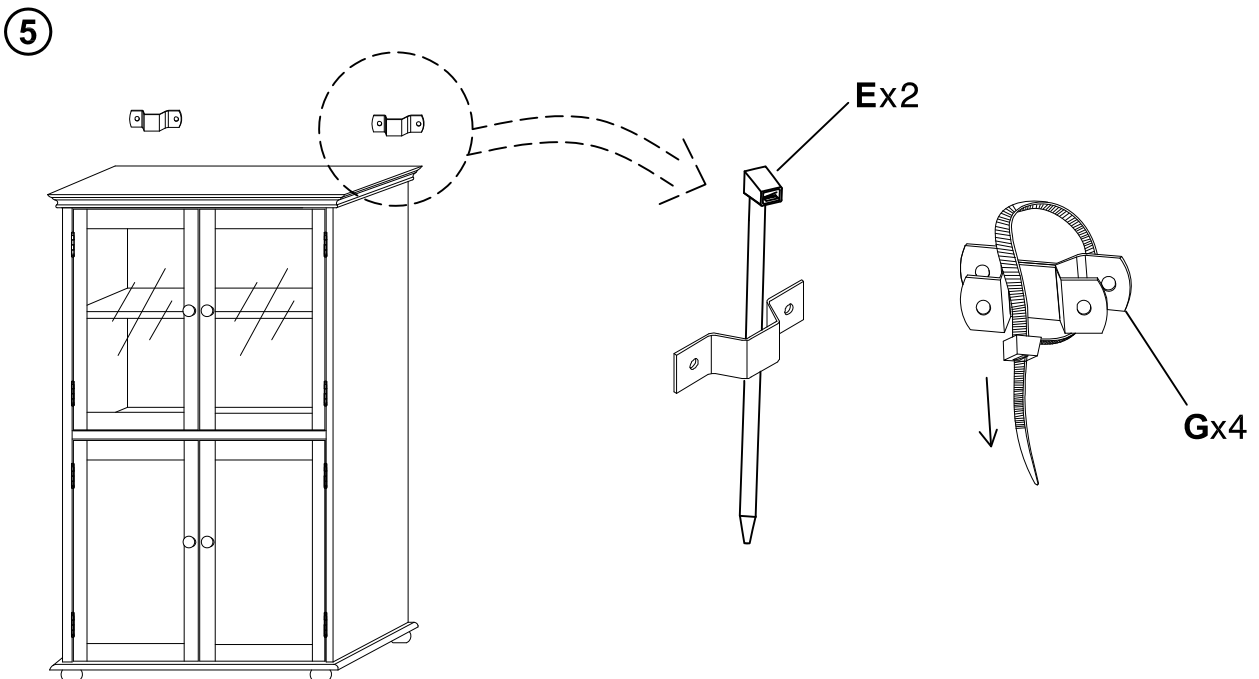
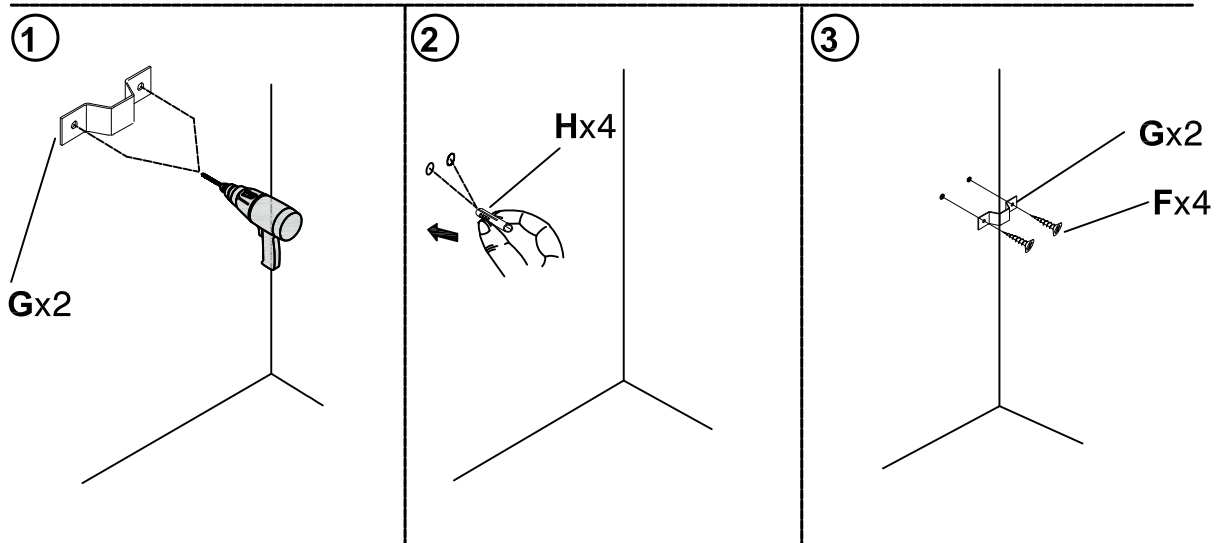

Maintenance

- If your furniture is stained or otherwise damaged during use, contact a professional for repairs.

Care and Cleaning

- Use a soft, clean cloth that will not scratch the surface when dusting.
- Use of furniture polishes is not necessary. Should you choose to use polishes, test the polish in an inconspicuous area before using over the entire surface of the product.
- Using solvents of any kind on your furniture may damage the finish.
- Never use water to clean your furniture as it may cause damage to the finish.
- Always use coasters under beverage glasses and flowerpots.
- Liquid spills should be removed immediately. Using a soft, clean cloth, blot the spill gently. Avoid rubbing.
- Always use protective pads under hot dishes and plates. Heat can cause chemical changes that may create spotting within the furniture finish.
- Use care as stains or marks from crayons or ink markers will be difficult to remove.
- Be sure to immediately clean red wine or soda stains within 30 minutes or the surface will stain.

"IMPORTANT HEALTH NOTICE.

SOME OF THE BUILDING MATERIALS USED IN THIS HOME (OR THESE BUILDING MATERIALS) EMIT FORMALDEHYDE. EYE, NOSE, AND THROAT IRRITATION, HEADACHE, NAUSEA AND A VARIETY OF ASTHMA-LIKE SYMPTOMS, INCLUDING SHORTNESS OF BREATH, HAVE BEEN REPORTED AS A RESULT OF FORMALDEHYDE EXPOSURE. ELDERLY PERSONS AND YOUNG CHILDREN, AS WELL AS ANYONE WITH A HISTORY OF ASTHMA, ALLERGIES, OR LUNG PROBLEMS, MAY BE AT GREATER RISK. RESEARCH IS CONTINUING ON THE POSSIBLE LONG-TERM EFFECTS OF EXPOSURE TO FORMALDEHYDE.

REDUCED VENTILATION MAY ALLOW FORMALDEHYDE AND OTHER CONTAMINANTS TO ACCUMULATE IN THE INDOOR AIR. HIGH INDOOR TEMPERATURES AND HUMIDITY RAISE FORMALDEHYDE LEVELS. WHEN A HOME IS TO BE LOCATED IN AREAS SUBJECT TO EXTREME SUMMER TEMPERATURES, AN AIR-CONDITIONING SYSTEM CAN BE USED TO CONTROL INDOOR TEMPERATURE LEVELS. OTHER MEANS OF CONTROLLED MECHANICAL VENTILATION CAN BE USED TO REDUCE LEVELS OF FORMALDEHYDE AND OTHER INDOOR AIR CONTAMINANTS.

IF YOU HAVE ANY QUESTIONS REGARDING THE HEALTH EFFECTS OF FORMALDEHYDE, CONSULT YOUR DOCTOR OR LOCAL HEALTH DEPARTMENT."

HOME DECORATORS COLLECTION

**Questions, problems, missing part? Before returning to the store,
call Home Decorators Collection Customer Service
8 a.m.-7p.m.,EST,Monday-Friday,9 a.m.- p.m.,EST,Saturday**

1-800-986-3460

HOMEDEPOT.COM/HOMEDECORATORS

Retain this manual for future use.