



TWV Series Patio Cover Installation Guide (Twin V Patio Cover)

(assembly for all sizes and number of posts)











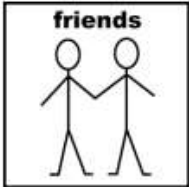

TWV Series Patio Cover Installation Guide



TOOLS

Recommended & required tools are not included but necessary for a successful installation of this solid cover patio kit as each structure & location is unique.

Each "Step" page will note required tools to complete each installation step

<p>1-2 friends</p> 	<p>Level & Square</p> 	<p>Sealant gun</p> 	<p>Hole saw (1-1/2" or 2")</p> 
<p>Hammer</p> 	<p>2x 6' step ladders</p> 	<p>Tin Snips</p> 	<p>Skill Saw or Chop Saw</p> 
<p>Tape measure</p> 	<p>3/8" Drill motor w/ extension cord</p> 	<p>Crescent wrench</p> 	<p>1/4", 5/16", 3/8" socket drive set</p> 



****If any parts are damaged or missing in action, please contact support@fourseasonsols.com or call 800.533.0887. We are available Mon to Fri, 9am to 5pm ET. Please leave a message if we cannot take your call, so we can call you back.****

TWV Series Patio Cover Installation Guide



PARTS

The Material Checklist located in Box 1 of your shipment lists the parts included with your kit.



part #1 0549706 _____
EX HNGR T/V MALE A WHT/WEA/IV __'__'__"
Hanging Channel



part # 1A 0549606 _____
EX HNGR T/V FEML A WHT/WEA/IV __'__'__"
Hanging Rail



part #2 6440420000
PVC FOAM WEATHERSTRIP (2-5/8") 50' rl
Foam Rubber Gasket
*This part is pre-installed into Part #1 for your convenience.



part #3 0536056 _____
EX FASC SMSN H WHT/WEA/IV __'__'__"
Side Fascia

TWV Series Patio Cover Installation Guide



PARTS (continued)



part #4 0540856_ _ _ _ _
EX GUTR SMSN H WHT/WEA/IV _ _ ' _ _ _ _"
Front Fascia



part #00 6440410000
TV EXTRUDED HANGING RAIL SPLIC 100/BX
Hanging Rail Splice

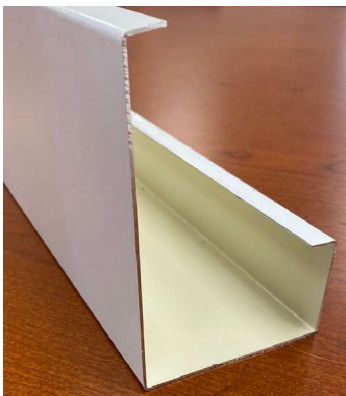

part #5 3020526700030
RA GUTR SMSN SPLICE WHT 30"
Front Fascia Splice



part #6 6440245000
6.5" FASCIA DAM (200 PC BX)
Front Fascia Dams

TWV Series Patio Cover Installation Guide



PARTS (continued)



part #7 101225__ _0000
GUTR SCUPPER SM P WHT/WEA/IV
Fascia Drain



part #8 0528456720001
EX CLIP PAN SMSN 2.5" H WHT 00'01"
Fascia Clip



part #9 3056766701110
RA VPAN TWIN 12x2.5 027 SM M WHT/WEA/IV P __ ' __"
12" Wide Roof Panel

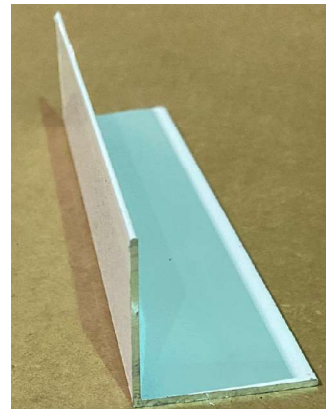

part #10 6440230630
6.5" R-FM CRNR PRESSBREAK POL WHT/
WEA/IV 50/bx
Corner Angle

TWV Series Patio Cover Installation Guide



part #11 6440425630
TWIN-VEE FLASHING 25" POL WHITE (100 PC)
Pre-formed Flashing



part #12A 0567756__1000
EX TUBE SQ 3" FLUT WHT/WEA/IV .068M 10'00"
3" Square Post

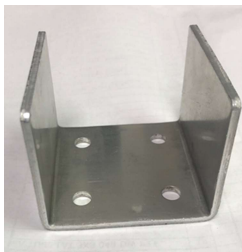

part #12B 2200330100
BASE HIDDEN 3" *DELUXE*
(2" leg) 100bx
Top Post Bracket

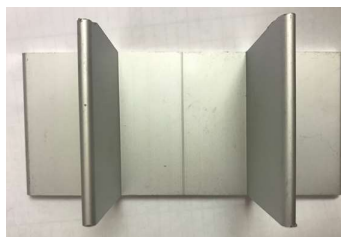

part #12C DP95031
BRACKET POST 3" SQ PP ALU HD
Bottom Post Bracket



part #13 80201220000
BLT 1/4"-20 x3/4 H/H ZN N/C
80851830000
NUT 1/4-20 H/H ZN N/C
1/4"x3/4" Bolt & Nut



part #14 80201370000
BLT 3/8"x3-1/2-16 H/H ZN N/C
80851845000 NUT 3/8"x-16 H/H ZN N/C
3/8"x3-1/2" Bolt & Nut



part #15 82453870000
WASH FLAT 1/4x3/4 ZN N/C
1/4"x3/4" Washer



part #15A 82403855000
WASH FLAT 3/8"x1-0/0 ZN N/C
3/8"x1" Washer

TWV Series Patio Cover Installation Guide



PARTS (continued)



part #16 81802555000
SCW SM-AB #10x3/8 H/H N/C SLT
#10x3/8" Screw



part #17 81802685000
SCW SM-AB #12x3-0/0 HWH ZN N/C
#12x3" Screw



part #18A 81953555_ _ _
SCW T2 #8x1/2 HWH ZN WHT/WEA/IV
#8x1/2" Screw



part #18B 81953370_ _ _
SCW T2 #14x1-0/0 HWH ZN WHT/WEA/IV 1c
#14x1" Tek Screw



part #19 80151085000
ANCR WEDGE 3/8"x2-3/4-16 H/H SS N/C
3/8"x2-3/4" Anchor

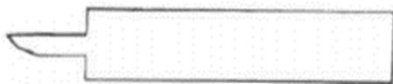

part #20 CK_ _ _ _ _
CAULK SILICONE "C.W.S." WHT/WEA/IV 12/bx
Caulking



part #21
1"x1"x7-3/4" spacer tube
Spacer Tube

TWV Series Patio Cover Installation Guide



Read each Step carefully before beginning installation.

Components and Assembly Instructions

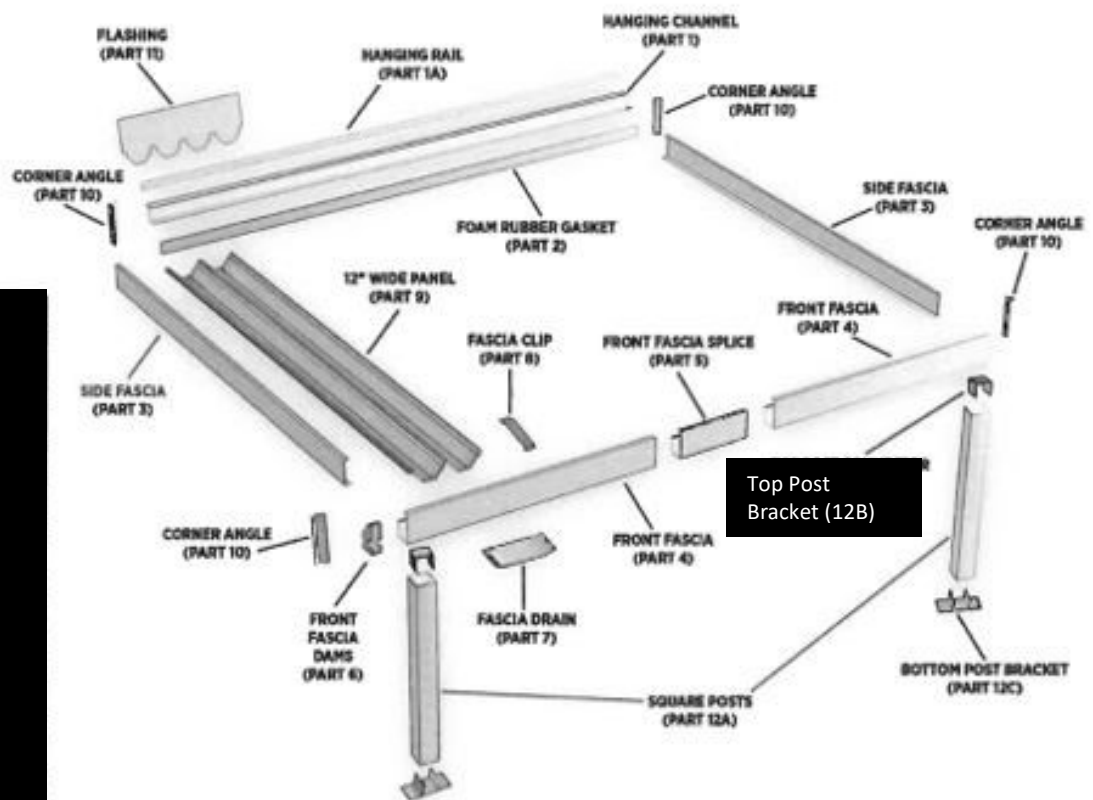

Part #	Description
1	Hanging Channel
1A	Hanging Rail
2	Foam Rubber Gasket
3	Side Fascia
4	Front Fascia
5	Front Fascia Splice
6	Front Fascia Dam
7	Fascia Drain
8	Fascia Clip
9	12" Wide Roof Panel
10	Corner Angle
11	Flashing
12A	Square Post
12B	Top Post Bracket
12C	Bottom Post Bracket
13	1/4" x 3/4" Bolt & Nut
14	3/8" x 3 1/2" Bolt & Nut
15	1/4" x 3/4" Washer
16	#10 x 3/8" Screw
17	#12 x 3" Screw
18A	#8 x 1/2" Tek Screw
18B	#14 x 1" Tek Screw
19	3/8" x 2 3/4" Anchor
20	Caulking
21	Spacer Tube

TWV Series Patio Cover Installation Guide



For Patio Covers wider than 16', please refer to page 41 first.

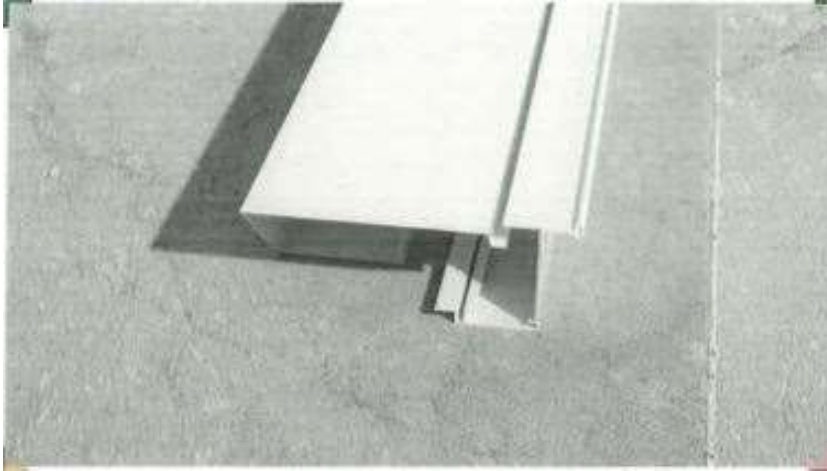

STEP 1-A: Preparing the Front Fascia & Hanging Channel

Lay the hanging channel and front fascia parallel and evenly on a flat, non-abrasive surface. Make sure both the front fascia and hanging channel rails remain even as shown. Tape both ends together.

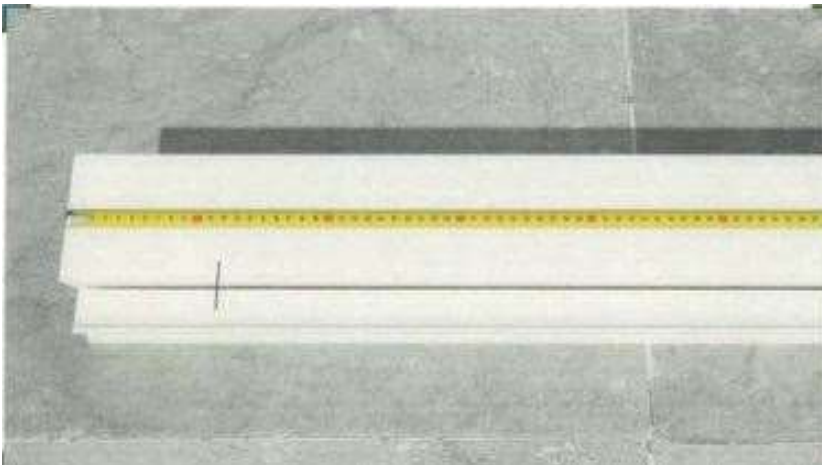

Step 1-B: Preparing the Front Fascia & Hanging Channel

Hook tape on the end and make the first mark on the Front Fascia and Hanging Channel 12 3/8" from the end. Then move the measuring tape to that first mark and proceed to mark every 12" with a pencil. These will be the CRITICAL center marks of the mated roof panels. DO NOT CUT the Front Fascia or Hanging Channel.

TWV Series Patio Cover Installation Guide

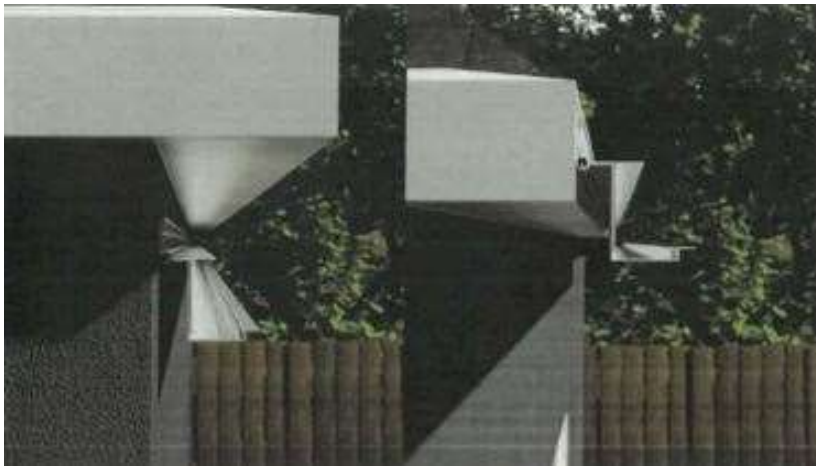

Step 2-A: Setting the Hanging Rail & Hanging Channel

Determine if mounting to house wall (Option 1) or to house fascia board (Option 2).



Step 2-B: Setting the Hanging Rail & Hanging Channel

If mounting per Option 1, mark the locations of the wall studs on the wall.

If mounting per Option 2, mark the locations of the roof rafter truss ends to the fascia board.

TWV Series Patio Cover Installation Guide



Step 2-C: Setting the Hanging Rail & Hanging Channel

Pre-drill 3 holes in the Hanging Rail using a 3/16" drill bit 2 inches from each end and one in the center. Fasten the Hanging Rail using #12 x 3" wood screws, keeping it level. Now mark the location of the wall studs or roof rafter truss ends onto the hanging rail.



Step 2-C: Setting the Hanging Rail & Hanging Channel

Pre-drill the 3/16" holes and fasten the rail using #12 x 3" wood screws.

TWV Series Patio Cover Installation Guide

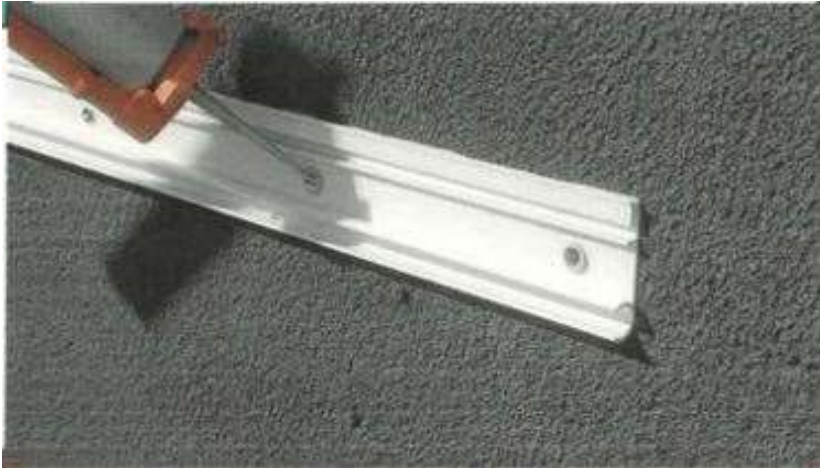

Step 2-D: Setting the Hanging Rail & Hanging Channel

If the Hanging Rail is in 2 pieces, butt them together. Caulk up and down the seam joint but not into the bottom open female groove. Caulk all screw heads in the Hanging Rail.



Step 2-E: Setting the Hanging Rail & Hanging Channel

Run a generous bead of sealant along the entire length of the Hanging Rail. Then, slide the Hanging Channel onto the Hanging Rail.

TWV Series Patio Cover Installation Guide

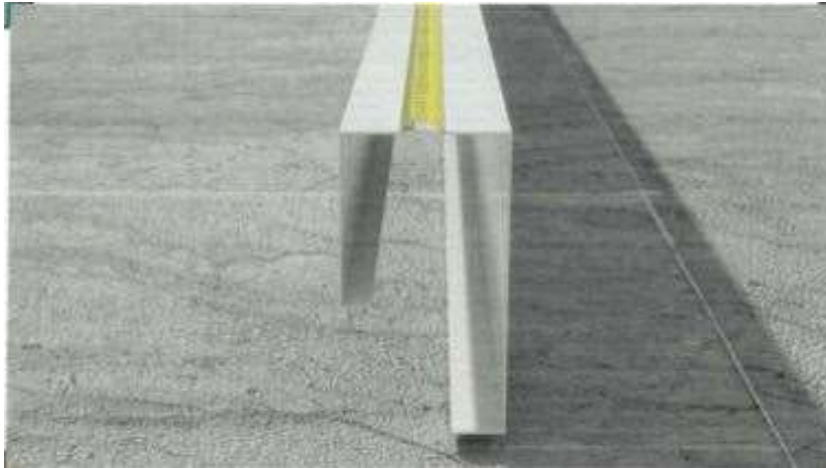

Step 3-A: Preparing the Front Fascia

Measure over 15" and 18" from each end for the Top Post Bracket locations.

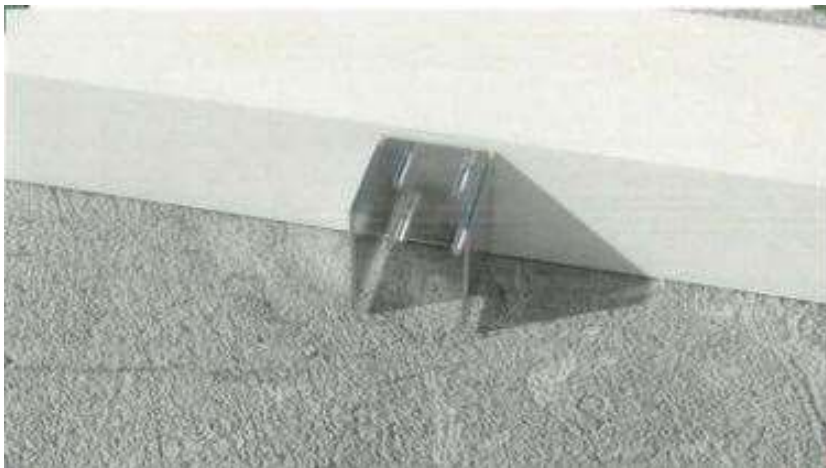

Step 3-B: Preparing the Front Fascia

Mark equal spacings for the remaining posts by dividing the entire space by the number of openings. For example, 3 posts = 2 openings; 4 posts = 3 openings, etc. Trace around the Top Base onto the Front Fascia bottom and re-check measurements.

TWV Series Patio Cover Installation Guide



Step 3-C: Preparing the Front Fascia

If your Top Post Bracket does not have pre-drilled holes, proceed to drill 4 holes $\frac{1}{4}$ " in the bottom of the base.

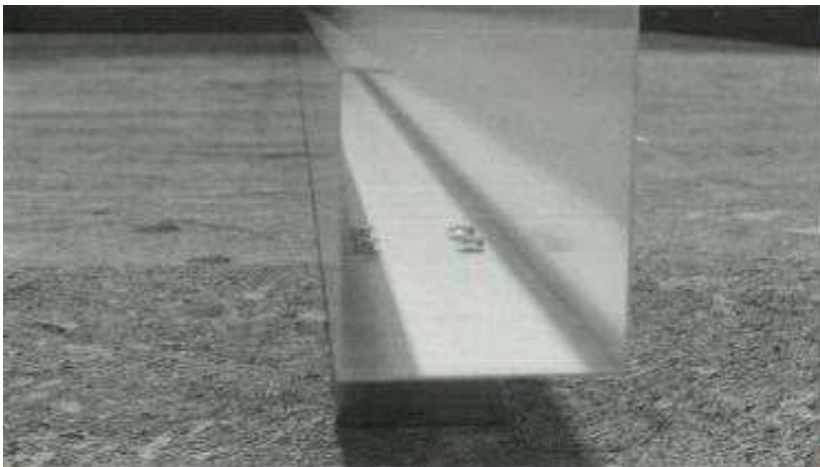

Step 3-D: Preparing the Front Fascia

Hold the Top Post Bracket to the marked post locations on the bottom of the Front Fascia. Mark the 4 hole locations and drill the four $\frac{1}{4}$ " holes. Insert the bolts from inside the Front Fascia downward through the Top Post Bracket. Fasten with the washer and nut.

TWV Series Patio Cover Installation Guide

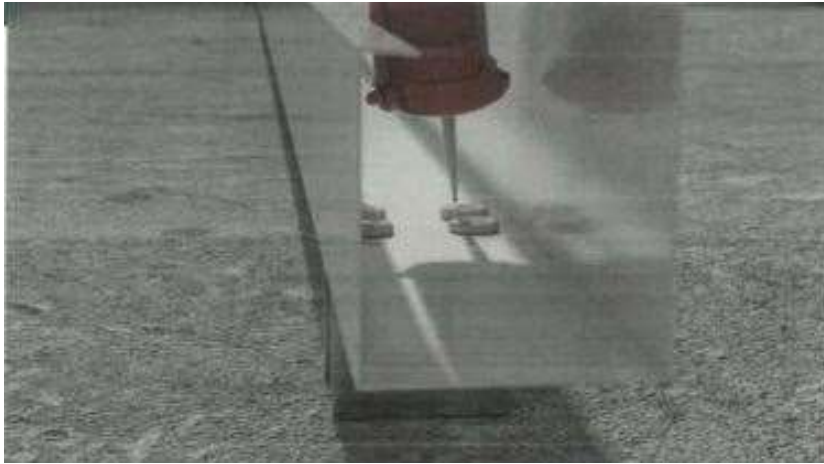

Step 3-E&F: Preparing the Front Fascia

Turn over the Front Fascia and set it on the fastened post brackets and caulk around every bolt head inside the Front Fascia.

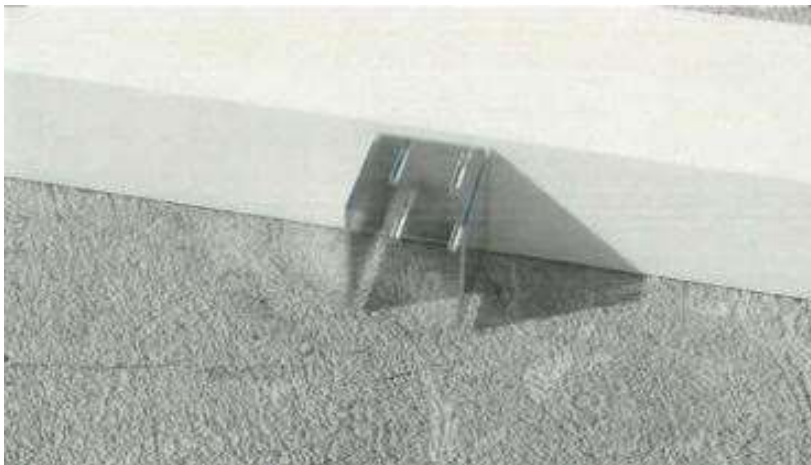

Step 3-E&F: Preparing the Front Fascia

Set the Front Fascia on the slab as shown.

TWV Series Patio Cover Installation Guide

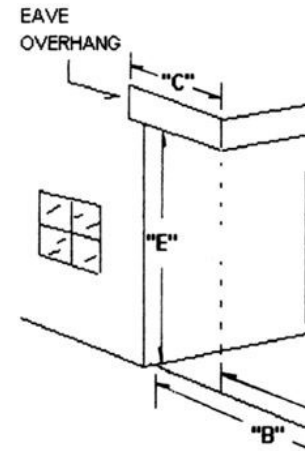
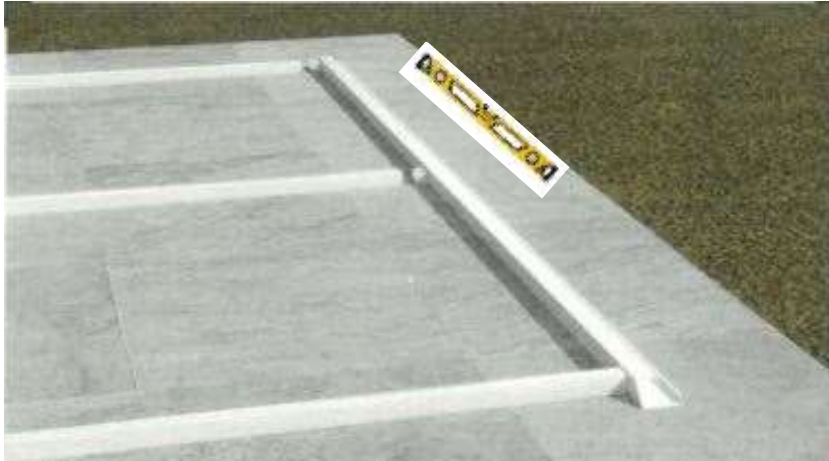

Step 4-A&B: Preparing & Fastening Posts to the Front Fascia

Place a level on the front edge of the slab to determine which is the low end of the slab—the left or right side. After determining the low side, measure from the slab up to the bottom of the Hanging Channel on that low side. You are determining the measurement for “E” depicted at right.

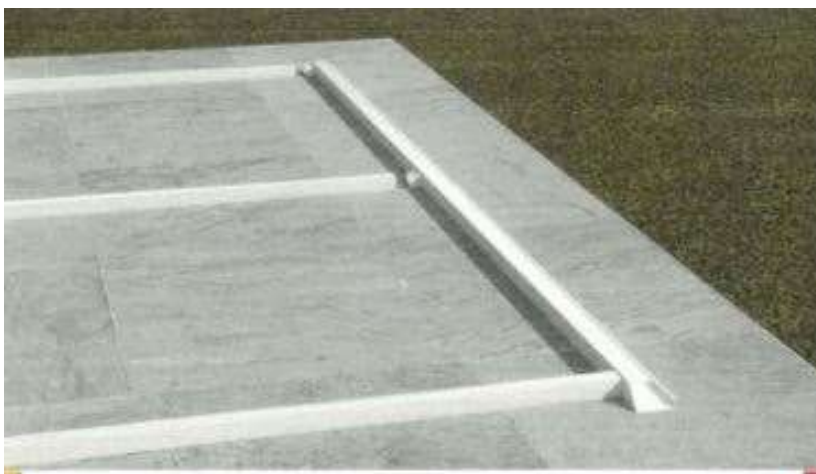

Step 4-C: Preparing & Fastening Posts to the Front Fascia

Then subtract 2 inches and subtract $\frac{1}{2}$ " per foot of depth of your patio cover. For example, if you have an 8' deep x 14' wide patio cover, use this formula: $8' \times \frac{1}{2}'' = 4$ inches. If you measured 98" from the bottom of the hanger you will subtract $98'' - 2'' = 96''$. Then $96'' - 4'' = 92''$ for your first post length.

TWV Series Patio Cover Installation Guide

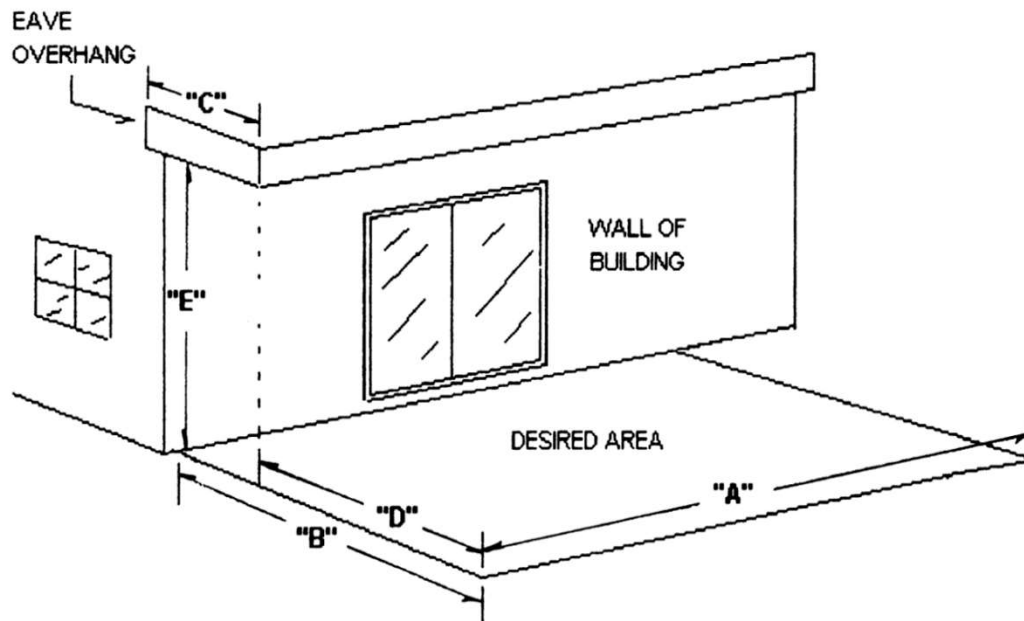

KEY

- "A" = Total width of patio cover
- "B" = Total projection of patio cover
- "C" = Eave overhang
- "D" = Total projection from eave
- "E" = Patio cover height

Measure the width of the area to be covered ("A"). Round to the nearest even foot increment. "A" will be the total width of the patio cover.

9' or 10' tall posts to be cut to desired height ("E").
Posts are evenly spaced across the total width ("A").

If mounting to a house wall

Measure the distance from the back wall of the building to the outside edge of the desired area ("B"). "B" will be the total projection of the patio cover.

OR

If attaching to the existing eave

Measure the distance from the wall to the outside of the eave ("C"). Subtract "C" from "B" (distance from the back wall to the Outside edge) to arrive at the measurement ("D"). "D" will be the total projection of the patio cover.

TWV Series Patio Cover Installation Guide

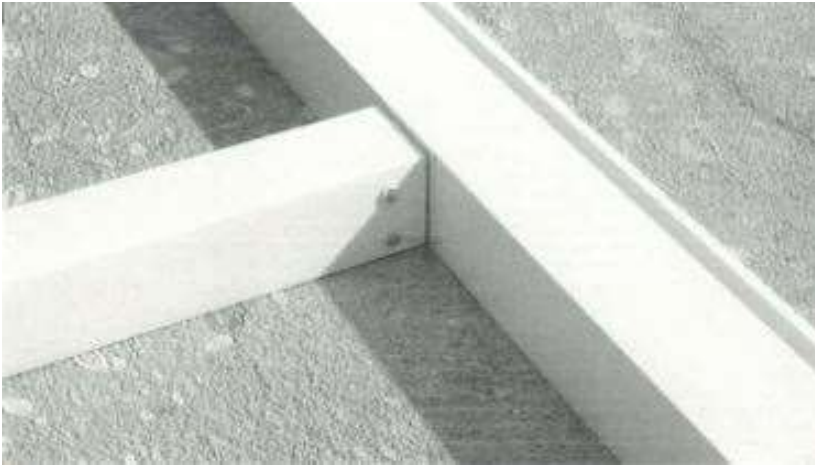

Step 4-D&E: Preparing & Fastening Posts to the Front Fascia

Cut the first Post, slip it over the Top Post Bracket on that low side. Drill two 3/8" holes completely through the post and the post bracket. Insert 2 3/8" x 3 1/2" holes through the post and brackets And fasten using 2 3 1/2" thru bolts. Insert two 3/8 x 3 1/2 screws through the bolts and fasten. Insert the bottom post bracket into the bottom of the post; drill two 3/8" holes through the posts and brackets. Fasten using two 3 1/2" screws through the bolts.



Step 4-F: Preparing & Fastening Posts to the Front Fascia

Place a ladder at the first end post for Person #1, place 2nd ladder near the opposite end post for Person #2. Stand up the attached Post and Front Fascia assembly while Person #2 is holding the Front Fascia level and holding a Post against the Front Fascia.

TWV Series Patio Cover Installation Guide



Step 4-G&H: Preparing & Fastening Posts to Front Fascia

Person #1 has level on Front Fascia, telling person #2 to move it up or down to the level position. Then, Person #2 marks the Post along the bottom of the Front Fascia. Note: Cut the post $\frac{1}{4}$ " below the pencil mark on the post to deduct for the bottom post bracket. Repeat Steps 4-D&E.



Step 4-I&J: Preparing & Fastening Posts to Front Fascia

If your patio cover has more than 2 Posts, stand up the Post and Front Fascia assembly, level the Fascia, mark the post along the Fascia bottom, cut posts $\frac{1}{4}$ " below the line and fasten by repeating Steps-D&E. All Posts tops should be thru bolted through the Top Post Bracket. All Post bottoms should be thru bolted through the Bottom Post Brackets.

TWV Series Patio Cover Installation Guide



Step 5-A: Setting the First Roof Panels

Raise the Front Fascia and Post assembly into position and temporarily stabilize the Front Fascia and Post in an upright position by tying each end Post to each ladder with a rope or cord. **DO NOT FASTEN** the Post bottom to the patio surface.



Step 5-B: Setting the First Roof Panels

Check the Front Fascia with a 4' level across the width of the patio cover (if adjustments are needed, remove a post and cut the bottom to make it level).

TWV Series Patio Cover Installation Guide



Step 5-C&D: Setting the First Roof Panels

Make sure the Right end of the Front Fascia is square to the right end of the Hanging Channel at the house. Slide the Roof Panel into the Hanging Channel against the foam with the “female” lock edge on the Right. Keep the panel flush/even to the Hanging Channel on the Right end and Front Fascia.

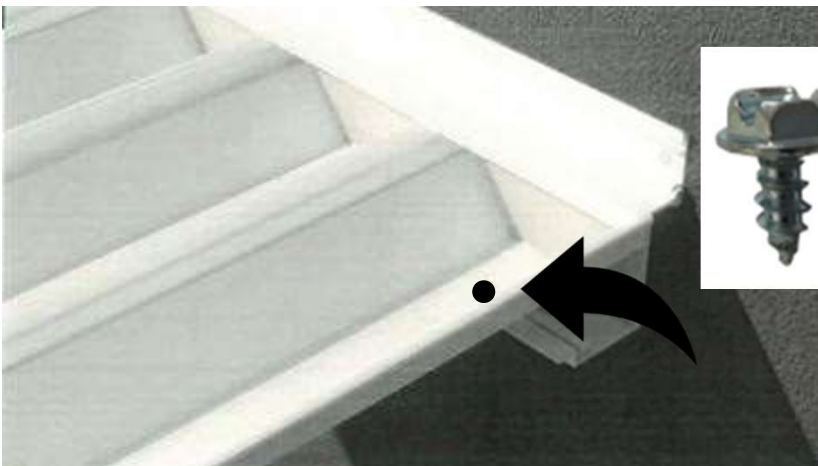

Step 5-E: Setting the First Roof Panels

The pre-punched holes in the roof panels should be lined up with the screw groove in the bottom lip of the Hanging Channel. Use one #10 x 3/8” SMS to fasten the first section of the roof panel to the Hanging Channel as shown. DO NOT fasten the second section of the Roof Panel yet.

TWV Series Patio Cover Installation Guide

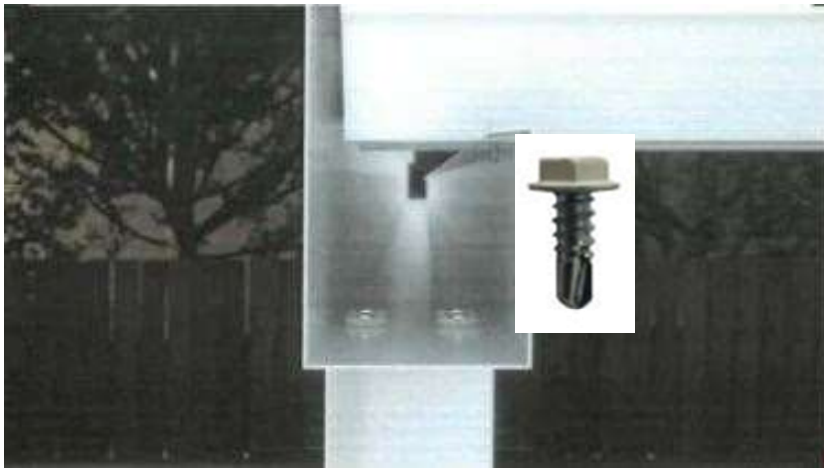

Step 5-F&G: Setting the First Roof Panels

Fasten the first section **ONLY** of the Roof Panel to the Front Fascia using one #8 tek screw. Have the Roof Panel **FLUSH** with the top lip of the front of the Front Fascia, leaving a 1" space from the Front Fascia. Use 4ft. Level to plumb/level the bottom of the end post in both directions (front and side). **DO NOT** anchor the post bottom yet.

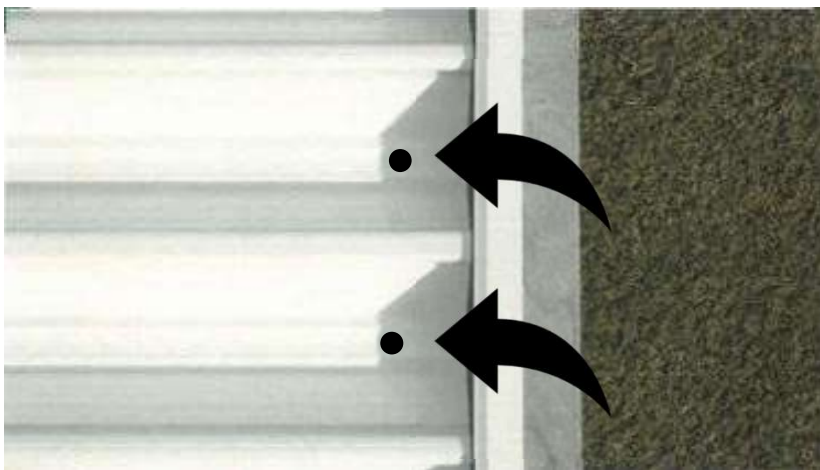

NOTE: The roof panel ends in line with the top lip of the Front Fascia.

TWV Series Patio Cover Installation Guide



Step 5-H: Setting the First Roof Panels

Take the second roof panel, got to the LEFT end of the Hanging Channel. Slide the Roof Panel into the Hanging Channel against the foam with the “female” lock edge on the Right. Keep the MALE edge even/flush to the Hanging Channel and Front Fascia on the LEFT end.



Step 5-H: Setting the First Roof Panels

The pre-punched holes in the Roof Panels should be lined up with the screw groove in the bottom lip of the Hanging Channel. Use one #10 x 3/8” SMS to fasten the first section of the Roof Panel to the Hanging Channel as show in Step 5-E.

TWV Series Patio Cover Installation Guide



Step 5-I&J: Setting the First Roof Panels

Fasten the last section **ONLY** of the Roof Panel to the Front Fascia using one #8 tek screw. Set the Roof Panel **EVEN/FLUSH** with the top leg of the Front Fascia, leaving a 1" space from the Front Fascia. Use a 4ft level to plumb the bottom of the end post in both directions (front and side). Do **NOT** anchor the post bottom yet.

TWV Series Patio Cover Installation Guide



Step 6A&B: Running the Roof Panels & Pre-Formed Flashing

Starting on the right end, get a new Roof Panel, FEMALE lock on the right side. Let this panel overhang a few inches OVER and past the Front Fascia.



Step 6-C: Running the Roof Panels & Pre-Formed Flashing

Set the FEMALE lock on top of the MALE lock of the first Roof Panel. Raise both Roof Panels Upward where they touch slightly to make a V shape, then slowly lock them together. Slide the New Roof Panel into the Hanging Channel against the foam weather stripping.

TWV Series Patio Cover Installation Guide



Step 6-D: Running the Roof Panels & Pre-Formed Flashing

***IT IS IMPORTANT TO align the CENTER OF THE SEAMS** of the overlapped/mated roof panels **WITH THE 12" MARKS** made on the **Hanging Channel and Front Fascia** from Step 1-B before fastening the Roof Panels.



Step 6-E&F: Running the Roof Panels & Pre-Formed Flashing

Slide the Roof Panel into the Hanging Channel foam and line up the holes with the screw groove in the Hanging Channel. Only fasten the **RIGHT HALF SIDE OF THE NEW ROOF PANEL** using one #10 x 3/8" SMS into the Hanging Channel screw groove and one #8 tek screw into the Front Fascia.

TWV Series Patio Cover Installation Guide

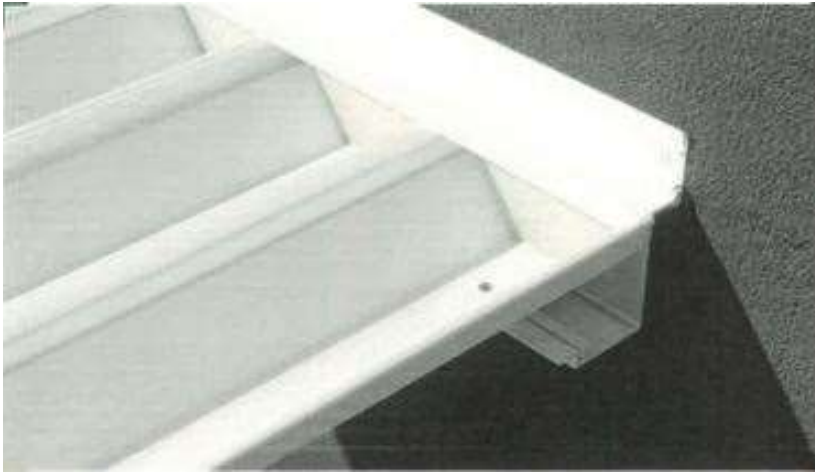

Step 6-G,H&I: Running the Roof Panels & Pre-Formed Flashing

Install, mate and lock the 3rd Roof Panel. *Push the Roof Panel so the mated seam of the 2 Roof Panels is in line with the 12" marks on the Hanging Channel and Front Fascia. Fasten the 3rd Roof Panel.



Step 6-G,H&I: Running the Roof Panels & Pre-Formed Flashing

Finish fastening the 1st and 2nd Roof Panels into the Hanging Channel as shown in Step 5-E using a #10 x 3/8" SMS into the screw groove. The Roof Panels should have 2 screws at both ends.

TWV Series Patio Cover Installation Guide

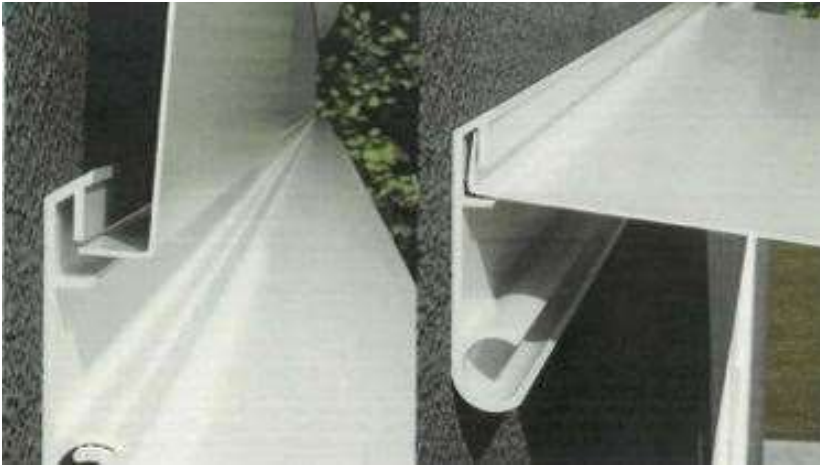

Step 6-J: Running the Roof Panels & Pre-Formed Flashing

Now you have 3 Roof Panels started on the right side. Take one Pre-Formed Flashing, holding it upright so the 5/16" leg is aligned into the Flashing Groove in the Hanging Rail. Slowly lower the Flashing down to the Roof Panel. Bend the tabs downward to go into the Roof Panel grooves to block leaves.

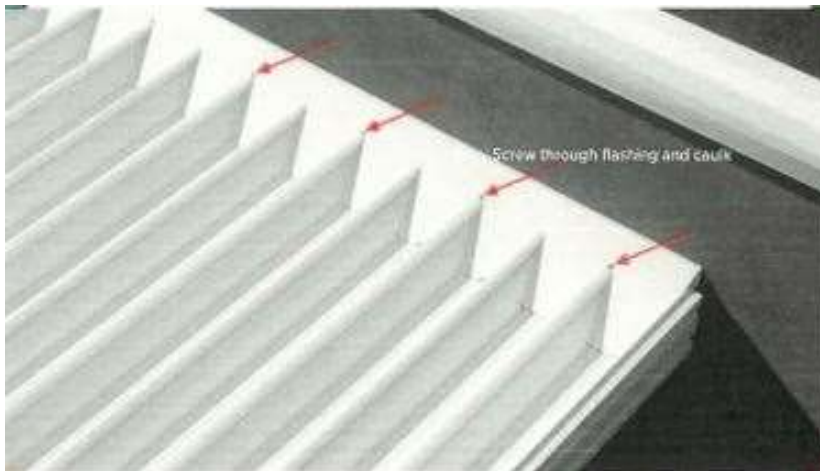

Step 6-K: Running the Roof Panels & Pre-Formed Flashing

Put a dab of Caulk Sealant under the first notch on the right where it rests on the roof panel. Fasten through the Flashing into the Roof Panel top using one #8 tek screw. Then put another dab of Caulk over the screw head.

TWV Series Patio Cover Installation Guide

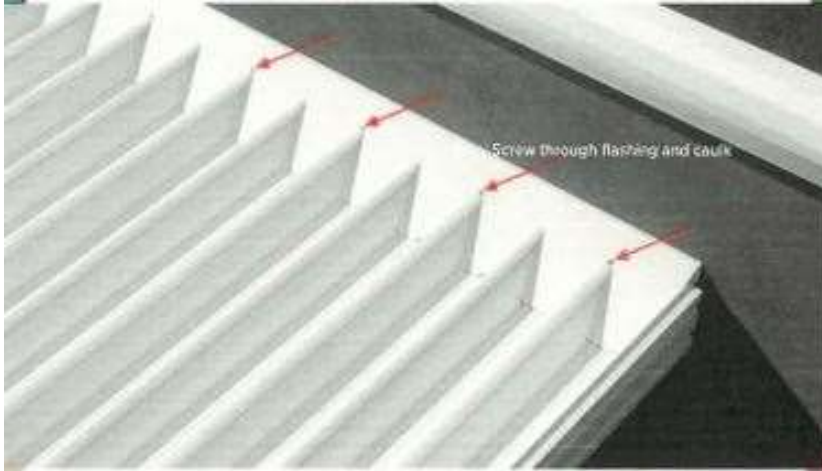

Step 6-L&M: Running the Roof Panels & Pre-Formed Flashing

After you run 2 more Roof Panels, having 3 Roof Panels exposed, MAKE SURE THE MATED ROOF PANEL SEAMS ARE IN LINE WITH THE 12" MARKS ON THE HANGING CHANNEL AND FRONT FASCIA. Fasten the next 2 Roof Panels with 2 screws at each end. Run the next Pre-Formed Flashing, repeating Steps-J&K. Be sure to caulk and fasten through both pieces of Flashing where they overlap, then fasten the Flashing through every other notch. Run all the Roof Panels and Pre-Formed Flashings.

TWV Series Patio Cover Installation Guide

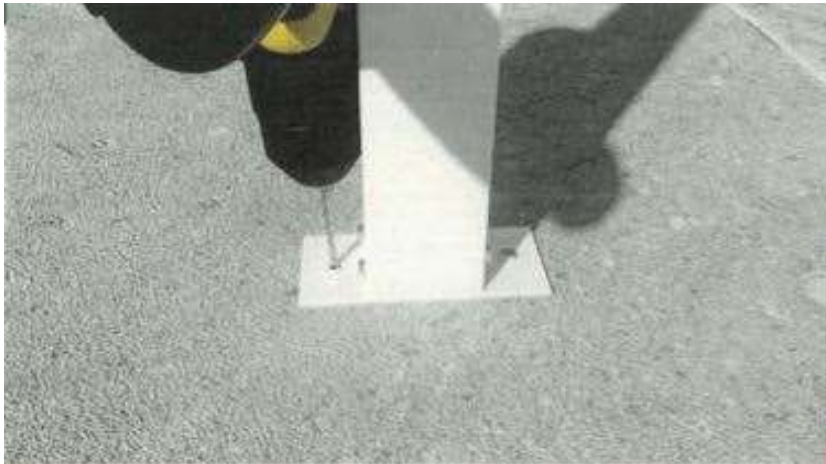

Step 7-A: Anchoring the Posts

Drill a 3/8" hole on each side of the Bottom Post Bracket. Each post must be plumb/level in both directions.



Step 7-B: Anchoring the Posts

Mark the Bottom Post Bracket position on the slab at the desired location. Drill 3/8" diameter holes through the Bottom Post Bracket into the slab with a masonry bit (not included). Tap the wedge anchors 3/8" x 2 3/4" into the holes.

TWV Series Patio Cover Installation Guide

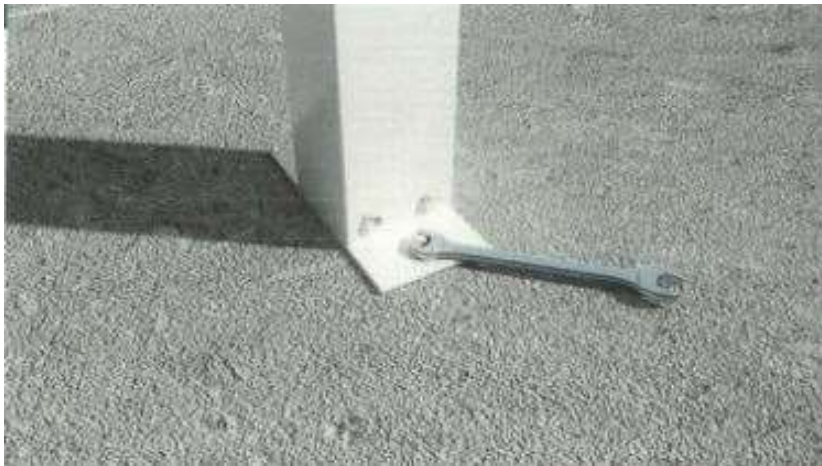

Step 7-C: Anchoring the Posts

Tighten the Wedge Anchor.

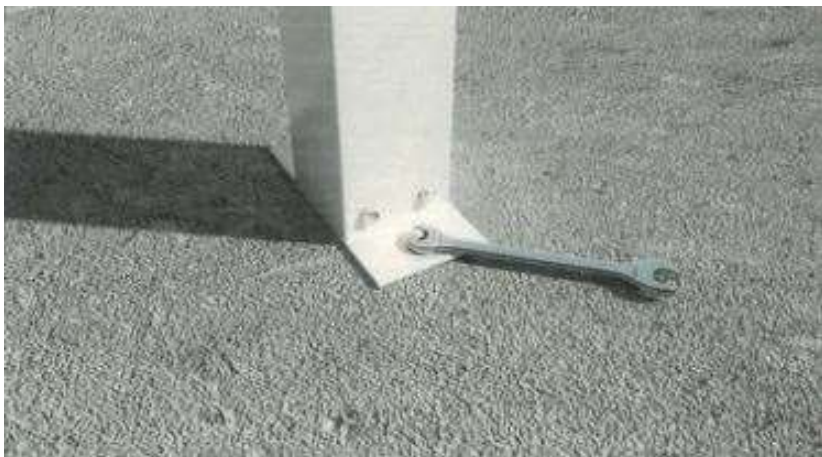

Step 7-D: Anchoring the Posts

Repeat Steps-A,B&C for all the Posts.

TWV Series Patio Cover Installation Guide



Step 8-A: Attaching the Side Fascia

With assistance, hold the Side Fascia against the house and front fascia. Check to see if you need to trim the Side Fascia at an angle to fit tight against the wall or house fascia.



Step 8-B: Attaching the Side Fascia

Cut the Side Fascia angles. **DO NOT CUT OFF TOO MUCH. JUST ENOUGH FOR THE ANGLE.** With a pencil, scribe the angle of the Front Fascia onto the Side Fascia, then cut the Side Fascia to fit. Test fit the Side Fascia to the Front Fascia.

TWV Series Patio Cover Installation Guide



Step 8-BB: Attaching the Side Fascia

Fasten two (2) pieces of the SPACER TUBE 1" x 1" x 7-3/4" under the TOP LEG of the SIDE FASCIA using 2 #8 x 1/2" tek screws. Set the SPACER TUBES at 1/3 and 2/3 of the SIDE FASCIA length.



TWV Series Patio Cover Installation Guide

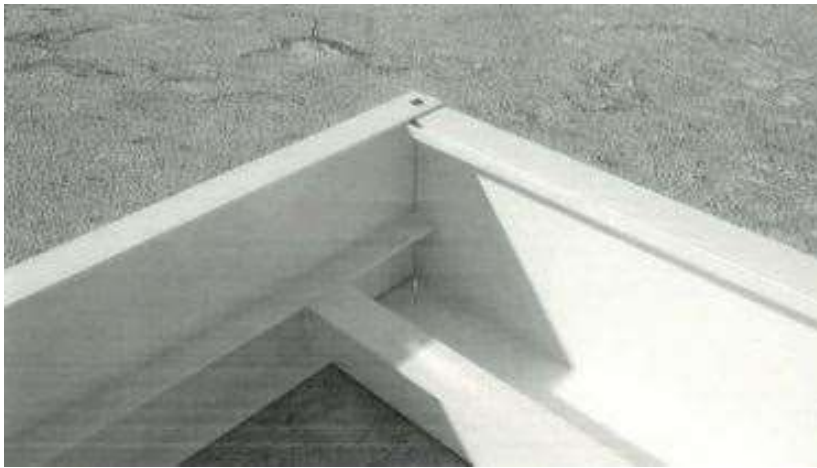

Step 8-C&D: Attaching the Front Fascia

Fasten the Side Fascia to the Front Fascia. The male or female lock of the Roof Panel should touch against the bottom of the Spacer Tube.



Step 8-E&F: Attaching the Side Fascia

Push the SIDE FASCIA upward so the MIDDLE LEG hits the BOTTOM of the HANGING CHANNEL at the house side and fasten UPWARD using one #8 x 1/2" tek screw. Fasten UPWARD through the male/female roof lock into the Spacer Tube using 2 #8 x 1/2" tek screws.

TWV Series Patio Cover Installation Guide

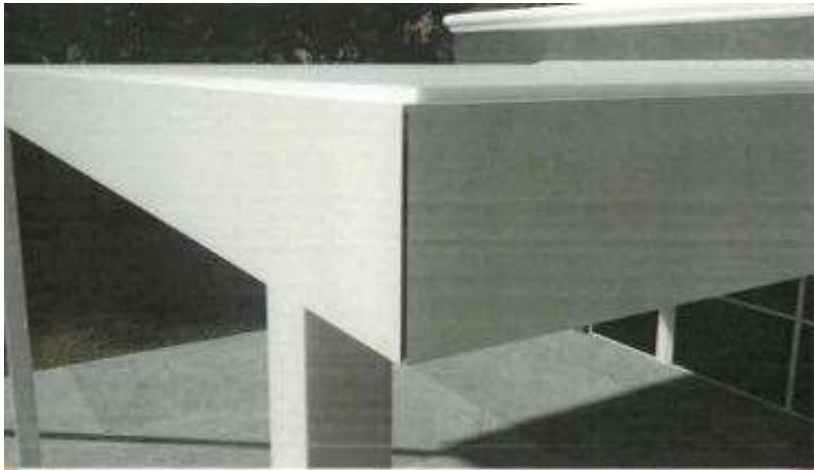

Step 9-A: Corner Angles

Place each Corner Angle flush to the Fascia bottom covering the corner joint.

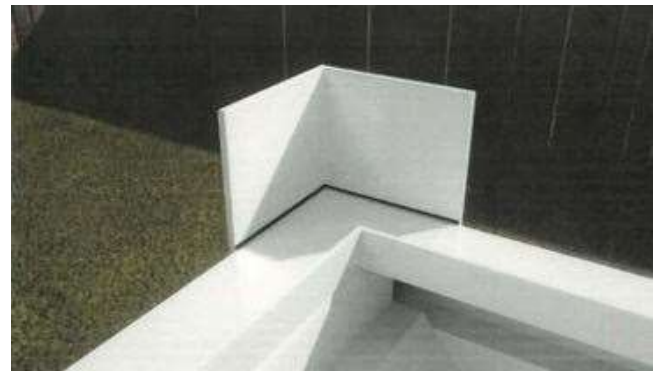
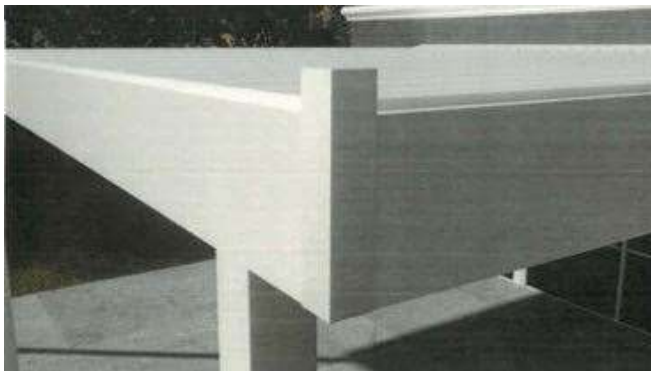

Step 9-B&C: Corner Angles

Mark the desired height of each Corner Angle and cut with tin snips or a metal saw. Fasten the Corner Angles using 2 #8 tek screws on each side. Caulk the inside corners of the Front Fascia and the Side Fascia to prevent leaks. Caulk all screws inside the Front Fascia to prevent leaks.

TWV Series Patio Cover Installation Guide

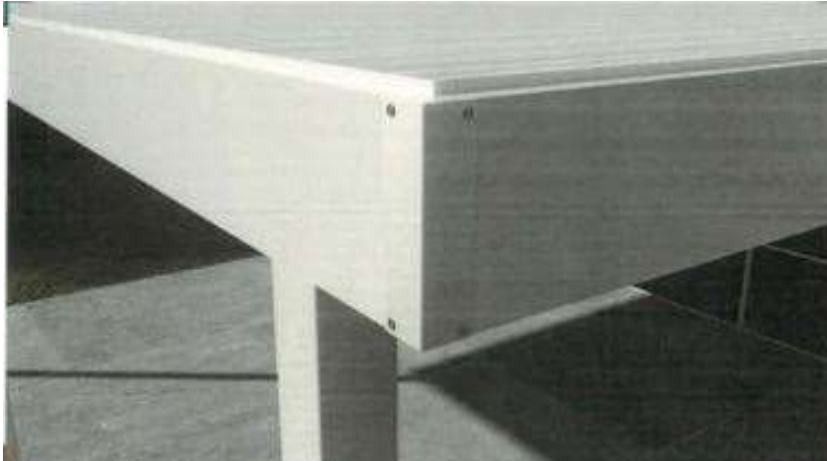

Step 9-D: Corner Angles

Cut the foam dams square and push them into the ends of the Front Fascia against the Side Fascia into the caulk, then caulk around the foam dam inside the Front Fascia.

TWV Series Patio Cover Installation Guide

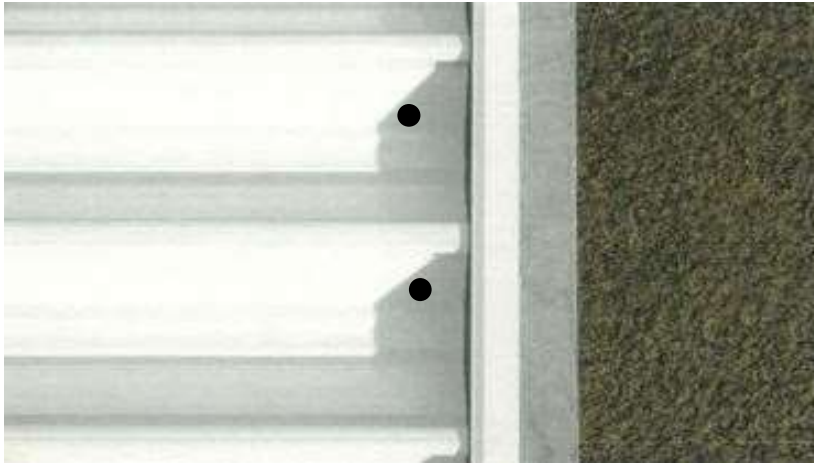

Step 10-A&B: Fascia Panel Clips

The Roof Panels should be flush/even with the top lip of the Front Fascia. Fascia Panel Clips should be centered where the Roof Panels overlap/mate together.

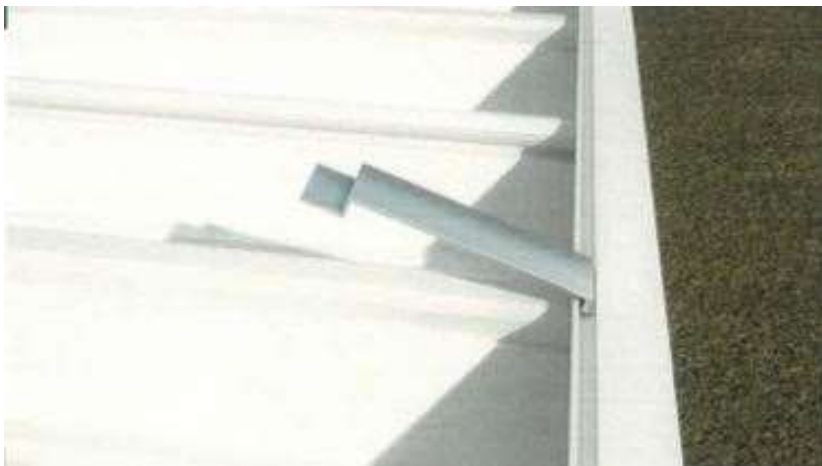

Step 10-C: Fascia Panel Clips

Insert the Fascia Panel Clip into the Front Fascia groove.

TWV Series Patio Cover Installation Guide

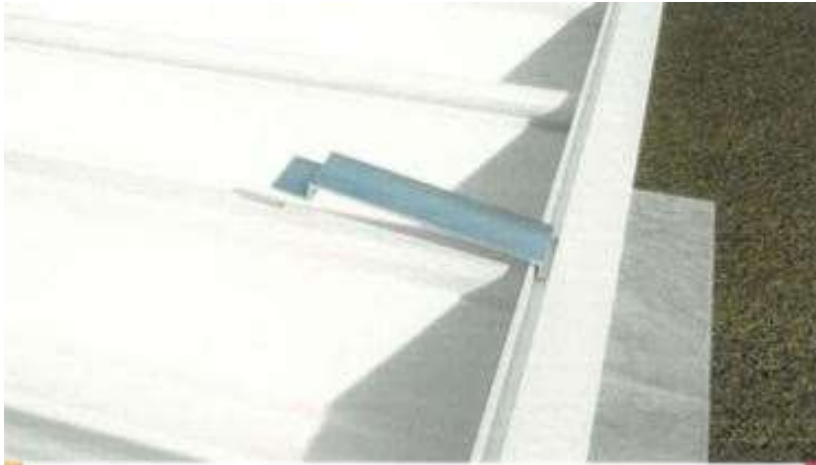

Step 10-D: Fascia Panel Clips

Make sure the Clip is centered where 2 Roof Panels are mated/locked together. Then slowly push the clip down and it will lock into the groove.

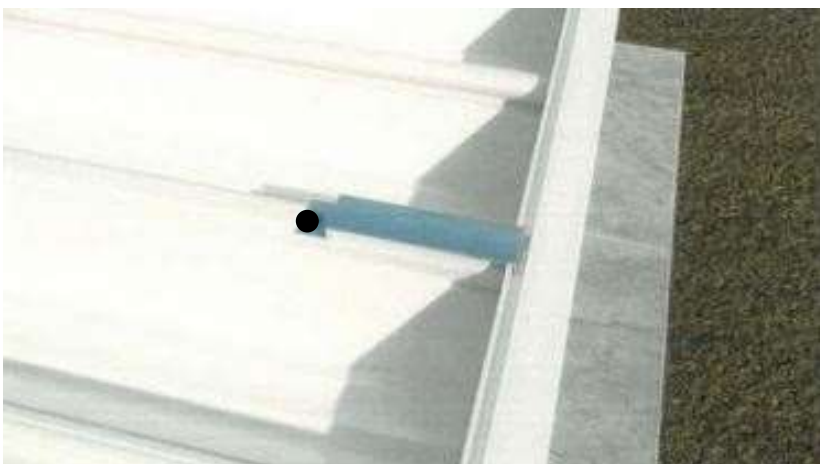

Step 10-E: Fascia Panel Clips

Fasten through the Clip into the Roof Panels using one #8 tek screw. Caulk the screw head. Caulk all #8 x 1/2" tek screws fastened through the Roof Panels into the Front Fascia. There should be 2 screws in each Roof Panel.

TWV Series Patio Cover Installation Guide



Type #1 Fascia Drain

Type #2 Fascia Drain



Step 11-A: Installing Fascia Drains

Measure 6" from both ends of the Front Fascia and mark with a pencil on the bottom in the center. Use a Hole Saw to cut a 1 1/2" or 2" diameter hole through the bottom of the Front Fascia.

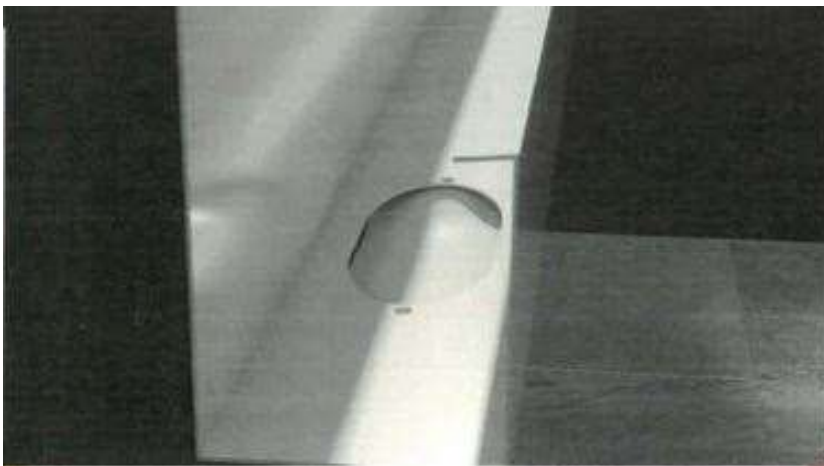

Step 11-B: Installing Fascia Drains

Run a small bead of caulk around the flange of the Fascia Drain. Center the Fascia Drain over the hole and press it against the bottom of the Front Fascia. The fasten using only 2 #8 tek screws upward into the Front Fascia.

TWV Series Patio Cover Installation Guide



Step 11-C: Installing the Fascia Drains

Inside the Front Fascia, caulk the 2 screws that fastened each Fascia Drain.

Step 12-A: Enjoyment of Your New TWV Series Patio Cover

Step back and admire the GREAT JOB you and your friends did in building this kit. Please take several pictures and send them to us at support@fourseasonsols.com. Please send a review to the website where you purchased the product, including your job pictures.

Please see our Installation Video for more assembly assistance:

www.fourseasonsoutdoorlivingsolutions.com/pages/twv-series-install-video

Call our customer service line for additional support: **800-533-0887**.

Available Mon to Fri, 9am to 5pm ET. Please leave a message if we do not answer and we will call you back.

TWV Series Patio Cover Installation Guide



Addendum for Fastening & Sealing the Splices

for TWV Series Patio Covers wider than 16 feet

Please refer to the following steps first, then proceed to Step 1A to begin installation.



Step 1: Preparing the Front Fascia Splice

Lay the Front Fascias parallel and evenly on a flat, non-abrasive surface. Measure your Front Fascia splice. If you live in the Midwest or Western US, your splice will be 12" and silver. If you live in the Central or Eastern US, your splice will be 30" and White.

TWV Series Patio Cover Installation Guide



Step 2-A: Preparing the Front Fascia & Splice

Hook your measuring tape inside the splice, measuring and marking at 6" inside the 12" splice. Measure over and mark at 15" inside the 30" splice.

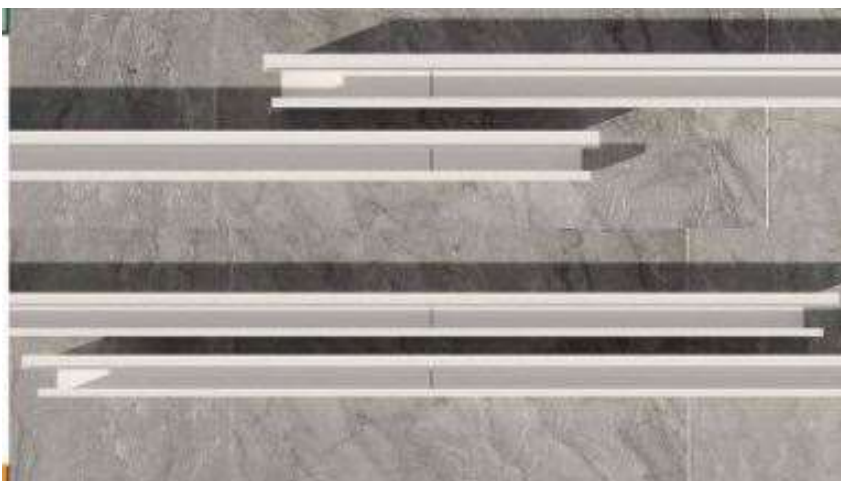

Step 2-B: Preparing the Front Fascia & Splice

Hook your measuring tape inside the Front Fascia. Measure and mark inside both Front Fascias 15" if you have the 30" splice. Measure and mark inside both Front Fascias 6" if you have the 12" splice.

TWV Series Patio Cover Installation Guide

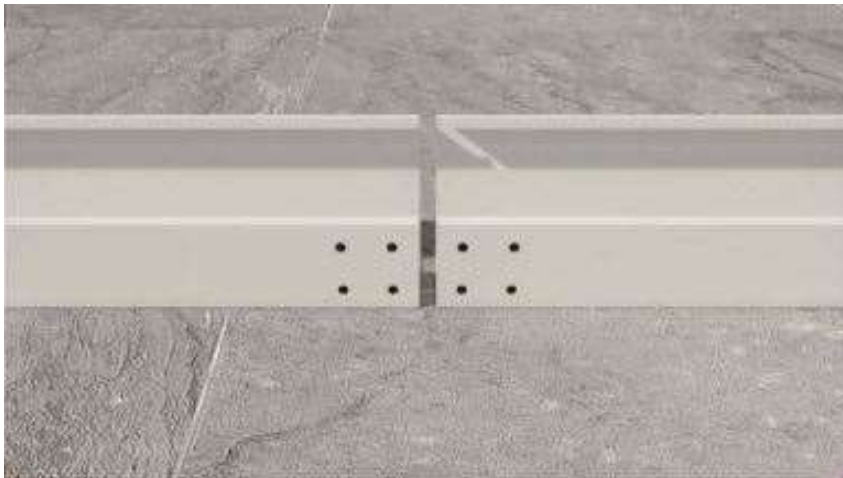

Step 3-A: Preparing the Front Fascia for 12" Splice

Hook a measuring tape on the back side of the Front Fascia. Measure over 2" and 4" in both directions of both pieces and mark with a pencil. Measure up $\frac{3}{4}$ " from the bottom and down $\frac{3}{4}$ " from the top. Mark the locations with a pencil.

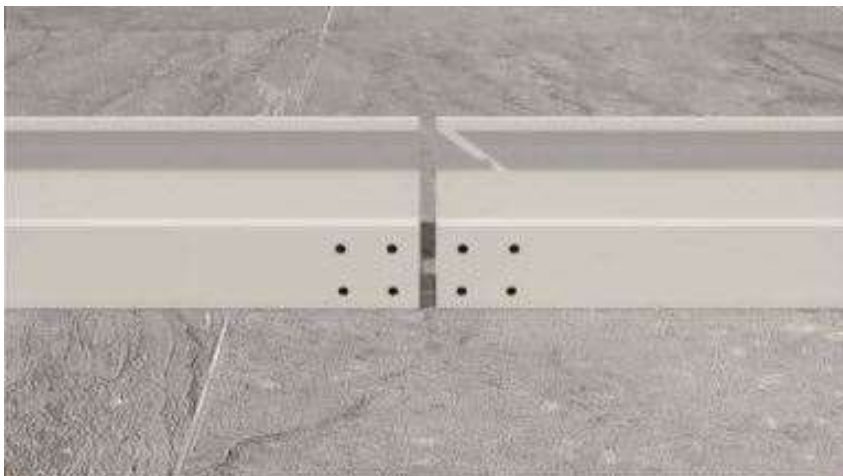

Step 3-B: Preparing the Front Fascia for 12" Splice

Hook a measuring tape on the back side of the Front Fascia. Measure over 2" and 4" in both directions of both pieces and mark with a pencil. Measure up $\frac{3}{4}$ " from the bottom and down $\frac{3}{4}$ " from the top. Mark the locations with a pencil.

TWV Series Patio Cover Installation Guide



Step 4-A: Preparing the Front Fascia Splice for 12" Splice

Hook a measuring tape on the end of the Front Fascia. Measure over 2" and 4" in both directions of both pieces and mark them with a pencil. Measure up 1 ¼" from the bottom and down 1 ¼" from the top. Mark these locations with a pencil.



Step 4-B: Preparing the Front Fascia Splice for 30" Splice

Hook a measuring tape on the end of the Front Fascia. Measure over 2" and 13" in both directions and mark them with a pencil. Measure up 1 ¼" from the bottom and down 1 ¼" from the top. Mark these locations with a pencil.

TWV Series Patio Cover Installation Guide



Step 5: Caulking Inside the Fascias

Caulk inside both fascias, staying one inch away from the end of both. Down both corners, up and down the front and back, with squiggly lines on the bottom.

TWV Series Patio Cover Installation Guide



Step 6-A: Inserting the Front Fascia Splice for 12" Splice

Insert the Fascia Splice in half-way 6" as shown. Push the splice down into the caulking and fasten using the #8 tek screws through the Front Fascia into the splice.



Step 6-B: Inserting the Front Fascia Splice for 30" Splice

Insert the Fascia Splice in half-way 15" as shown. Push the splice down into the caulking and fasten using the #8 tek screws through the Front Fascia into the splice where it's marked on both sides.

TWV Series Patio Cover Installation Guide



Step 7: Fastening the Front Fascia Splice

Make sure both pieces of Front Fascia are straight. Then slide the 2nd Fascia and fasten with Screws on the marks on the BACK AND FRONT OF THE FASCIA.



Step 8: Caulking the Front Fascia Splice

Caulk inside the Front Fascia at the ends of the splice and going up the front and back sides. Caulk all the screws protruding inside the fascia and the splice.