

Alaterre Furniture

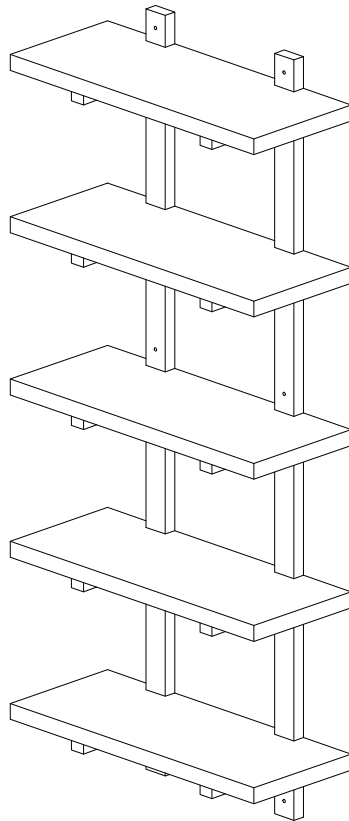

Bathroom 20x48" Wall Storage



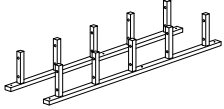

Thank you for purchasing the Bathroom 20x48" Wall Storage from ALATERRE FURNITURE. We have found it helpful to have a second person present during the assembly process.

Wall Storage Assembly Instructions

Parts

NO.	DRAWING	DESCRIPTION	QTY
A		METAL FRAME	2
B		SHELF	5

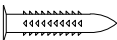
NO.	DRAWING	DESCRIPTION	QTY
C		M6x35MM BOLT	20
D		4x60MM SCREW	6
E		ALLEN KEY	1
F		DRYWALL EZ ANCHOR	6

Step 1

Read through these instructions thoroughly before beginning assembly. We have found this to be of great value when assembling this product.

Step 2

Remove all parts and hardware from packing material. Wooden pieces should be placed on a non abrasive surface to prevent damage to the finish

Step 3

Lay Metal Frame Assembly (A) on a non abrasive surface. Attach Shelf (B) to Metal Frame (A) using 20-M6x35MM Hex Bolts (C). NOTE: TIGHTEN ALL BOLTS AT THIS TIME !

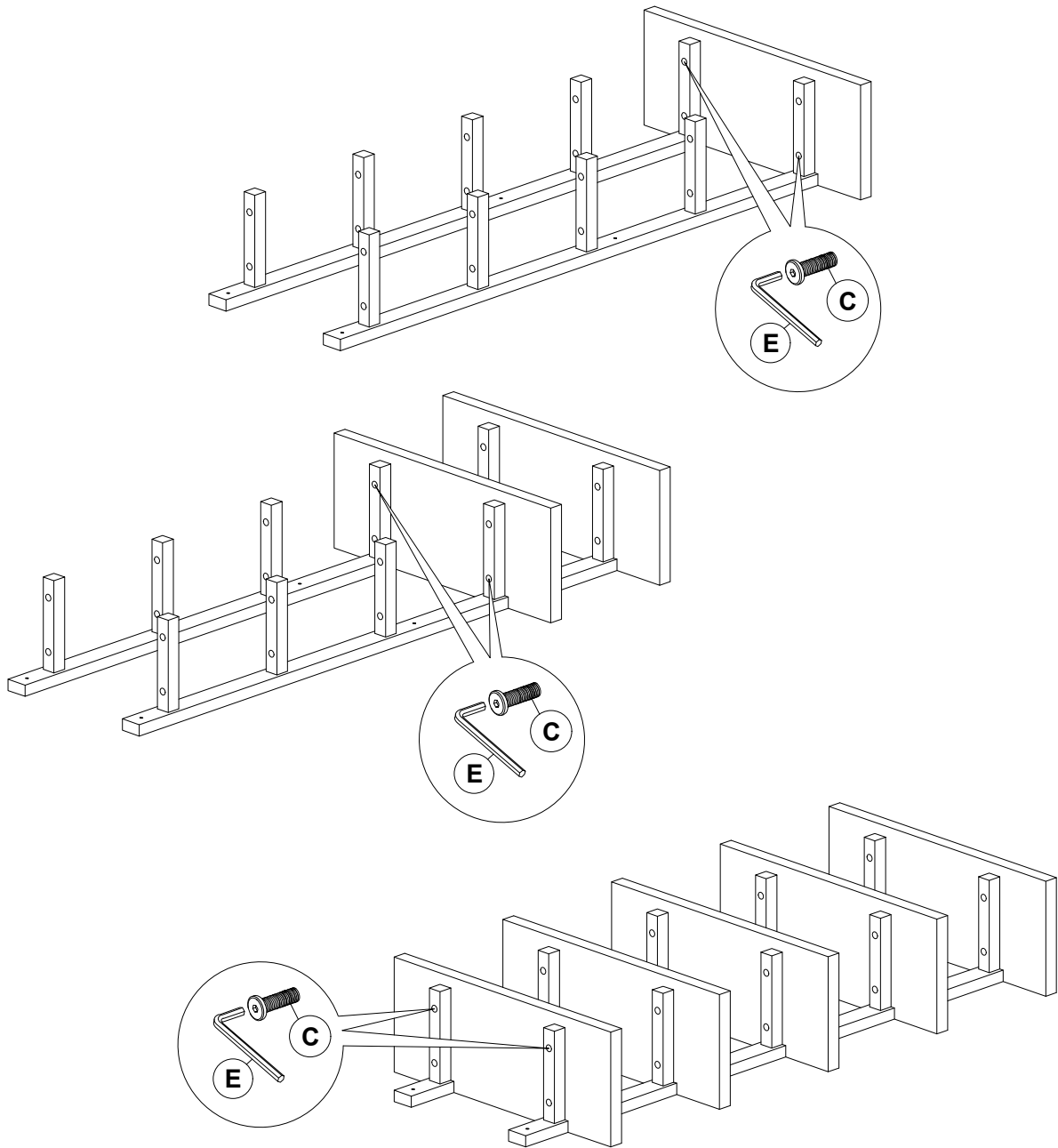

Step 4

Position Wall Storage in desired location. Mark holes where metal frame will be attach to wall. If possible, attach the Wall Storage to a stud (when possible) behind drywall using 6-4x60MM Wood Screws (D).

NOTE: If hole locations do not align with stud, install the Drywall EZ Anchors (F). Tap the EZ Anchor into the drywall up to the thread. Using a Phillips head screw driver, secure the EZ Anchor in the drywall at the desired locations. Attach the Wall Storage to the EZ Anchors using 6-4x60MM Wood Screws.

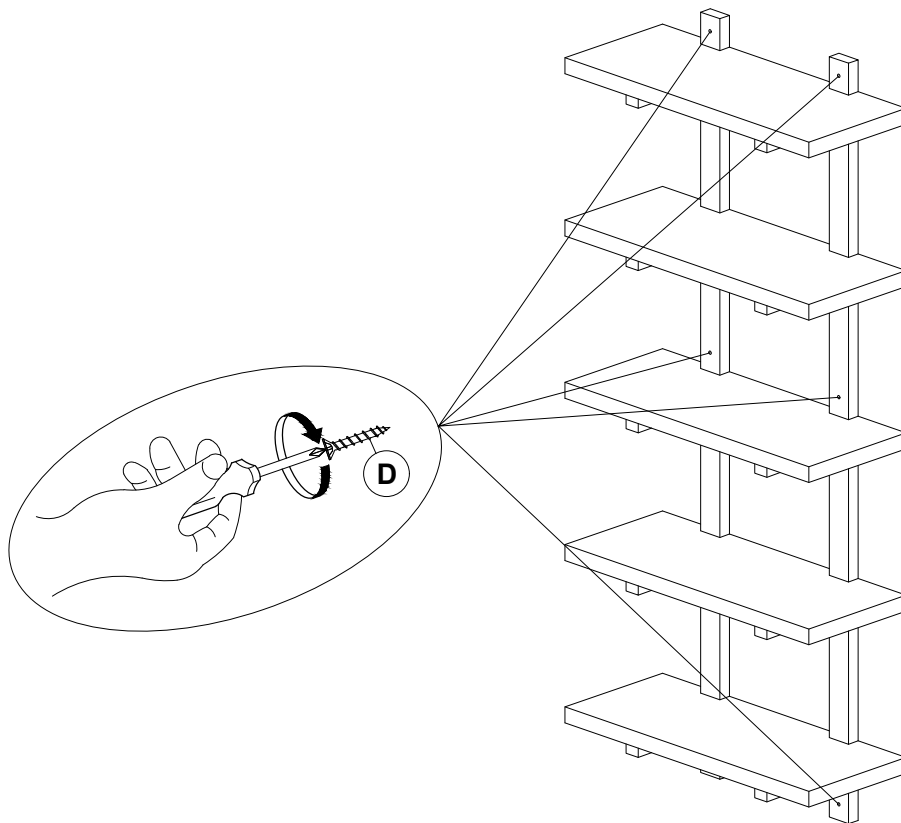

CARE

Clean with a non abrasive cloth using a mild soap. Make sure to wipe dry.

REPLACEMENT PARTS:

For best service, to order replacement parts go to www.alaterrefurniture.com. Use the order form on the website to order your replacement parts. Thank You!