

Home Decorators

— Collection —

BF-21892 HAMPTON BAY LINEN STANDARD CABINET

ASSEMBLY INSTRUCTIONS



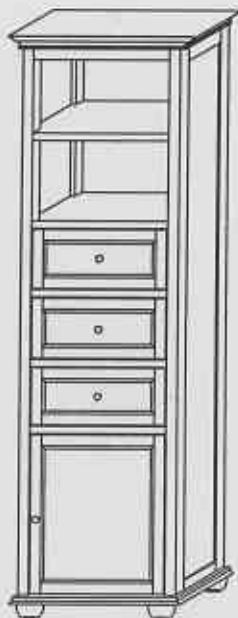





Made In China

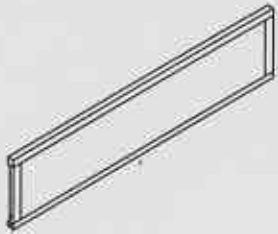
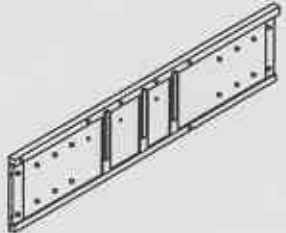

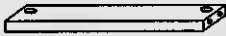



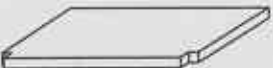



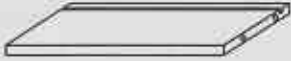







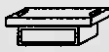

Thank you for purchasing this quality product. Be sure to check all packing material carefully for small parts, which may have come loose inside the carton during shipment. Count all parts and material hardware, Compare with parts list to be sure all part are present. If any parts are missing or damaged, phone, fax, or mail to our Customer Service Department. For efficient and speedy service please indicate the model number and code letter of part(s) need

IMPORTANT NOTE: Follow instructions listed below in proper sequence as numbered to assure fast, easy and correct assembly.

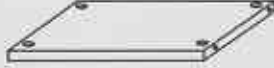
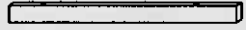
PARTS LIST

<p style="text-align: center;">A</p>  <p style="text-align: center;">TOP PANEL-1PC</p>	<p style="text-align: center;">B</p>  <p style="text-align: center;">RIGHT SIDE PANEL-1PC</p>	<p style="text-align: center;">C</p>  <p style="text-align: center;">LEFT SIDE PANEL-1PC</p>
<p style="text-align: center;">D</p>  <p style="text-align: center;">BOTTOM PANEL-1PC</p>	<p style="text-align: center;">E</p>  <p style="text-align: center;">ACROSS PANEL-2PCS</p>	<p style="text-align: center;">F</p>  <p style="text-align: center;">ACROSS PANEL-1PC</p>
<p style="text-align: center;">G</p>  <p style="text-align: center;">BACK PANEL-1PC</p>	<p style="text-align: center;">H</p>  <p style="text-align: center;">FEETS-4PCS</p>	<p style="text-align: center;">I</p>  <p style="text-align: center;">DOOR-1PC</p>
<p style="text-align: center;">J</p>  <p style="text-align: center;">SHELF-2PCS</p>	<p style="text-align: center;">K</p>  <p style="text-align: center;">DRAWER PANEL FRONT-3PCS</p>	<p style="text-align: center;">L</p>  <p style="text-align: center;">DRAWER PANEL SIDE-6PCS</p>

<p>M</p>  <p>DRAWER PANEL BACK-3PCS</p>	<p>N</p>  <p>DRAWER PANEL BOTTOM-3PCS</p>	<p>O</p>  <p>CAM-LOCKS-20PCS</p>	
<p>P</p>  <p>CAM-BOLTS-20PCS</p>	<p>Q</p>  <p>SCREWS-34PCS</p>	<p>R</p>  <p>SCREWS-17PCS</p>	
<p>S</p>  <p>FEMALE MAGNETS-1PC</p>	<p>T</p>  <p>SHELF SUPPORTS-8PCS</p>	<p>U</p>  <p>SCREWS-24PCS</p>	
<p>V</p>  <p>SCREWS-4PCS</p>	<p>W</p>  <p>KNOB-4PCS</p>	<p>X</p>  <p>MAGNETS-1PC</p>	<p>Y</p>  <p>DOWELS-7PCS</p>
<p>Z</p>  <p>CAM-TOOL-1PC</p>	<p>A1</p>  <p>HINGE-2PCS</p>	<p>B1</p>  <p>ACROSS PANEL-1PC</p>	<p>C1</p>  <p>LOW PANEL-1PC</p>
<p>J1</p>  <p>SCREWS-2PCS</p>	<p>K1</p>  <p>SCREWS-2PCS</p>	<p>L1</p>  <p>POTHOOK-2PCS</p>	<p>M1</p>  <p>SCREWS-2PCS</p>

NOTE: • UPON OPENING THOROUGHLY CLEAN ALL WOODS SURFACES TO REMOVE DUST AND DIRT THAT MAY HAVE SETTLED ONTO FINISH DURING SHIPMENT. IN ORDER TO PREVENT DAMAGE DURING ASSEMBLY, PLEASE ASSEMBLE THIS ITEM WITH AT LEAST TWO PEOPLE.

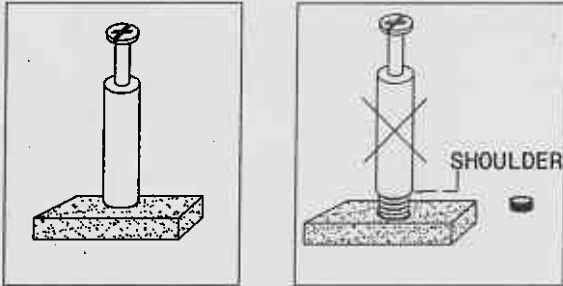

NOTE: TURN THE CAM-BOLT SCREWS UNTIL THEY ARE TIGHT, THE SHOULDER SHOULD BE AGAINST THE SURFACE OF THE PART.

HOW TO USE THE CAM-TOOL

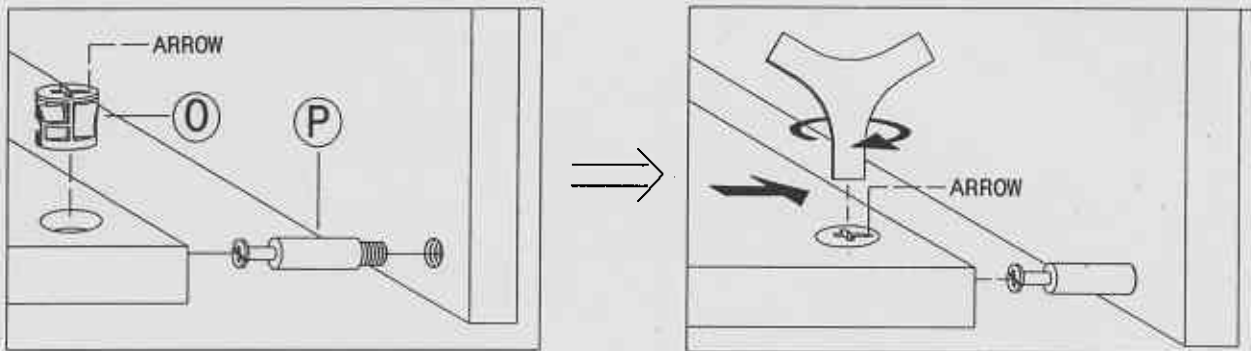

NOTE: • THE ARROWS ON THE HIDDEN CAM-LOCKS SHOULD POINT TO THE CAM-BOLTS

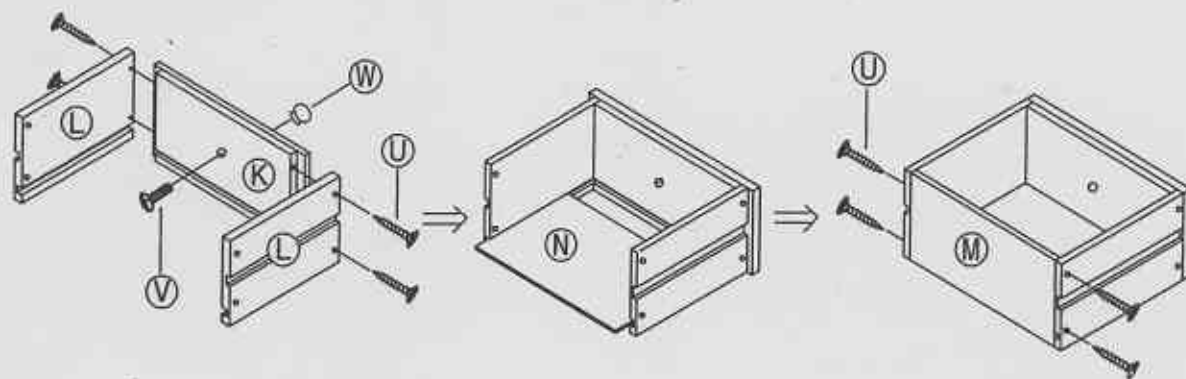

1) . ASSEMBLE THE DRAWER.

- ATTACH SIDE DRAWER PANEL(L) USING SCREWS(U) AND ATTACH KNOB(W) USING SCREWS(V) .
- INSERT THE DRAWER PANEL BOTTOM(N) INTO SLOTS IN SIDE DRAWER PANEL(L) .
- ATTACH THE DRAWER PANEL BACK(M) TO SIDE DRAWER PANEL(L) USING SCREWS(U) .

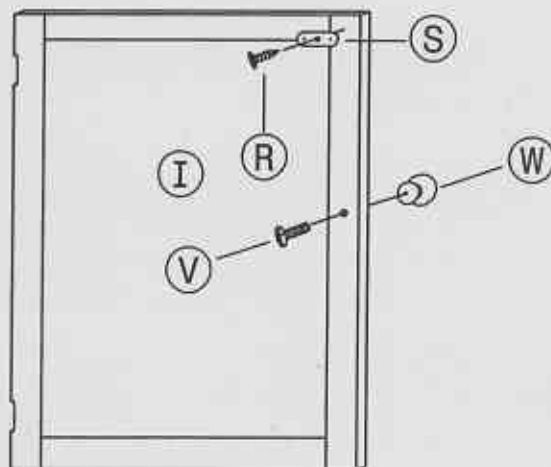

2) . ASSEMBLE THE DOOR(I) .

- ATTACH KNOB(W) TO DOORS(I) USING SCREWS(V) .
- ATTACH FEMALE MAGNETS(S) TO DOORS(I) USING SCREWS(R) .

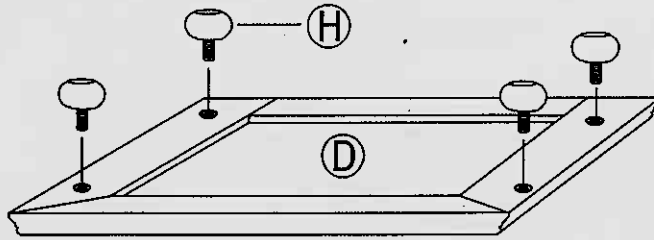

3) . ASSEMBLE THE FEETS(H) .

- ROTATE THE 4 FEETS(H) INTO HOLES IN BOTTOM PANEL(D) .

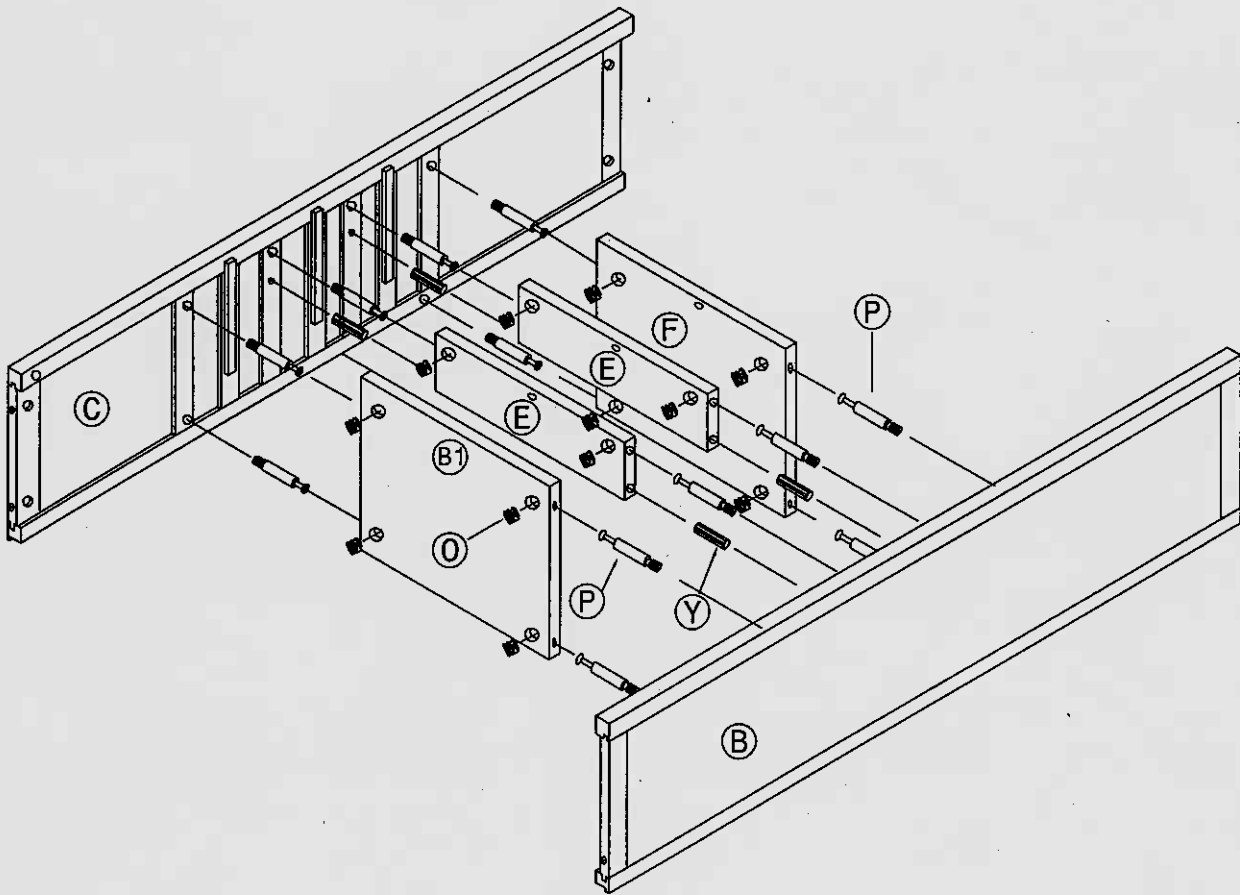

4) . ASSEMBLE THE SIDE PANEL(B/C) .

- INSERT THE 4 DOWELS(Y) INTO HOLES IN ACROSS PANEL(E) .
- ROTATE THE CAM-BOLTS(P) INTO HOLES INTO SIDE PANEL(B/C) .
- PLACE THE CAM-BOLTS(P) INTO HOLES IN PANEL(E/F/B1) AND ATTACH USING CAM-LOCKS(O) .

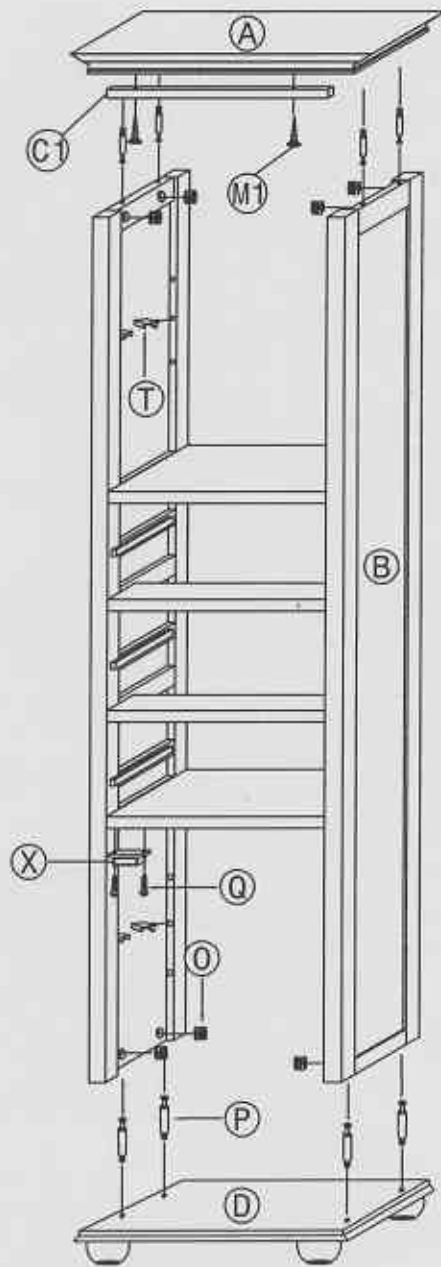

5) . ASSEMBLE THE TOP PANEL (A) .

- ATTACH THE LOW PANEL (C1) USING SCREWS (M1) IN HOLES OF PRIDRIL TOP PANEL (A) .
- ROTATE THE CAM-BOLTS (P) INTO HOLES INTO TOP & BOTTOM PANEL (A/D) .
- PLACE THE CAM-BOLTS (P) INTO HOLES IN SIDE PANEL (B/C) AND ATTACH USING CAM-LOCKS (O) .
- INSERT THE 8 SHELF SUPPORTS (T) INTO HOLES IN SIDE PANEL (B/C) .
- FINALLY, ATTACH MAGNETS (X) USING SCREWS (Q) IN THE PREDRILLED HOLES OF PANEL (B1) .

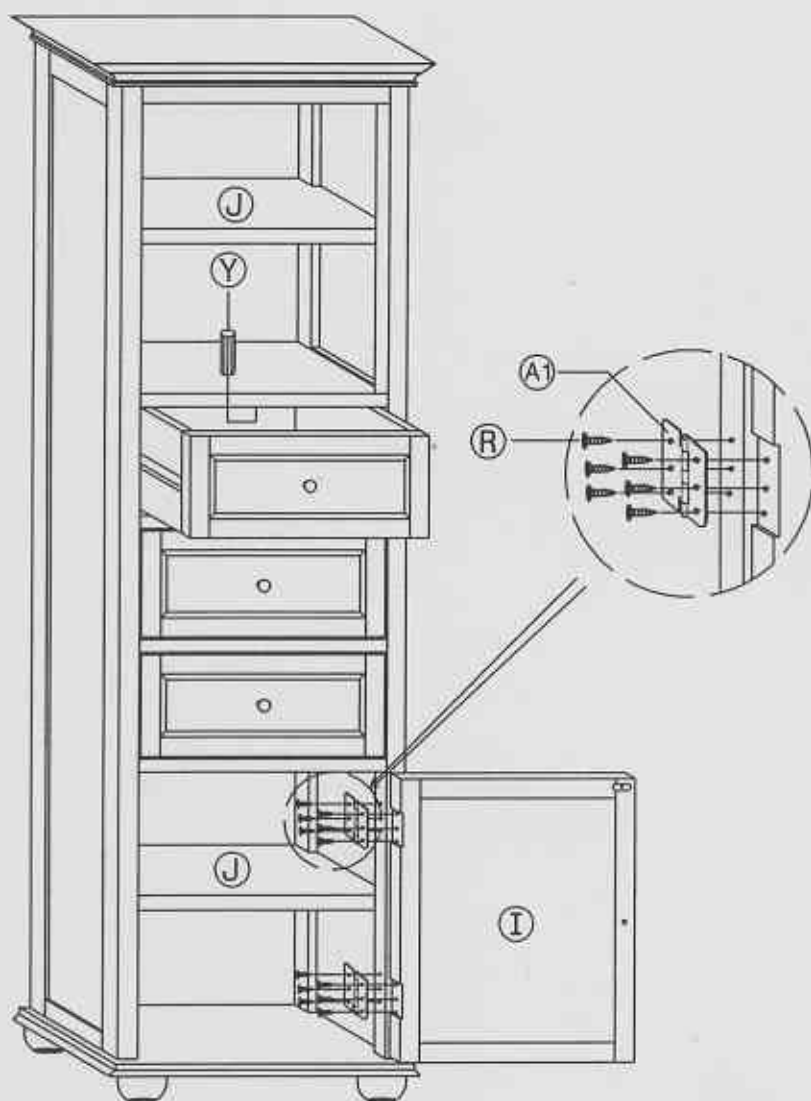

6) . ASSEMBLE THE DOORS(I) .

- ATTACH 2 HINGES(A1) TO DOORS(I) AND RIGHT SIDE PANEL(B) USING 12 SCREWS(R) .
- INSERT THE DOWELS(Y) INTO HOLES IN PANEL(F/E) AND SLIDE DRAWER INTO WOOD SLIDERS.
- FINALLY, PUT THE 2 SHELF(J) ONTO THE SHELF SUPPORTS(T) .

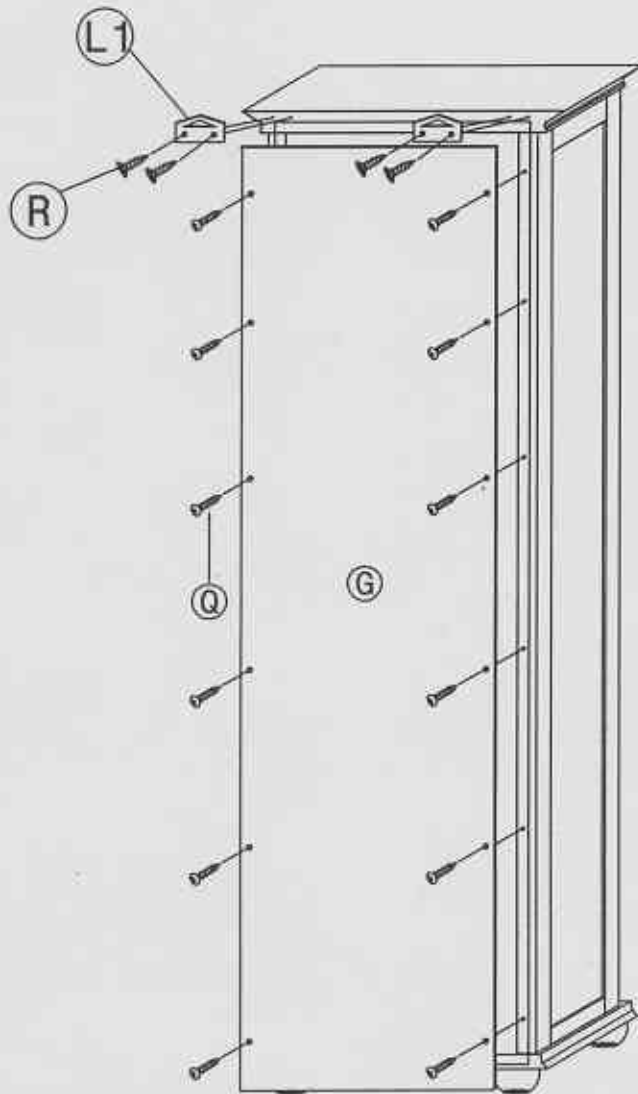

7) . ASSEMBLE THE BACK PANEL (G) .

- ATTACH BACK PANEL (G) USING SCREWS (Q) INTO REAR OF THE TOP, BOTTOM, AND SIDE PANEL .
- ATTACH THE POTHOOK (L1) IN HOLES OF PRIDRIL TOP TANEL (A) AND USING SCREWS (R) .

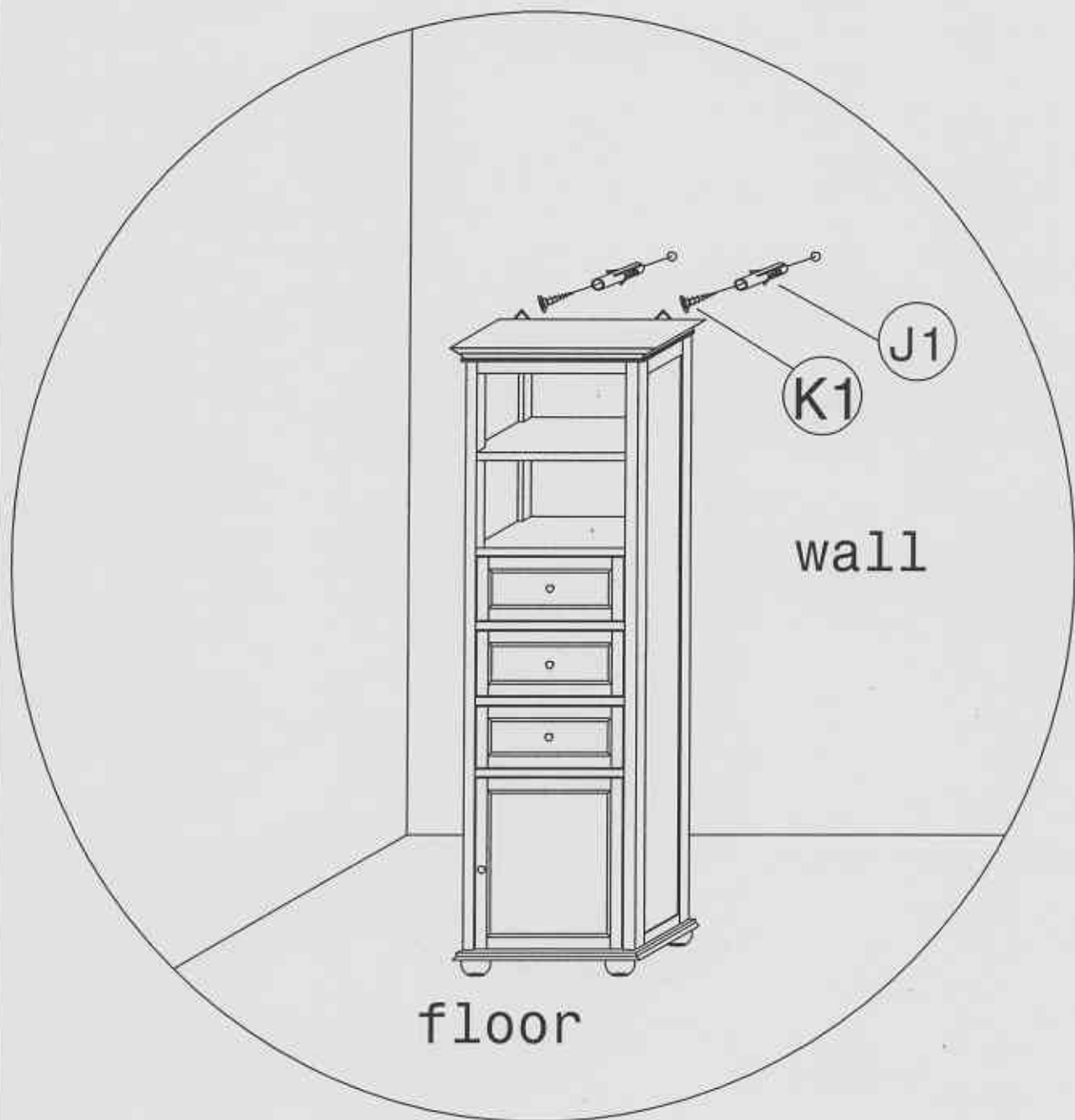

8) . ATTACH TO WALL

- DRILL TWO HOLES IN THE WALL EQUAL TO THE DISTANCE OF THE POTHOOK HANGERS.
- INSERT THE SCREWS(J1) INTO THE HOLES ON THE WALL, YOU MAY NEED A HAMMER.
- ROTATE 2 SCREWS(K1) INTO THE WALL SCREWS(J1) AND HANG ON THE WALL SCREWS.