

SM-EB808-02

**ENGING**

**BLOWER**

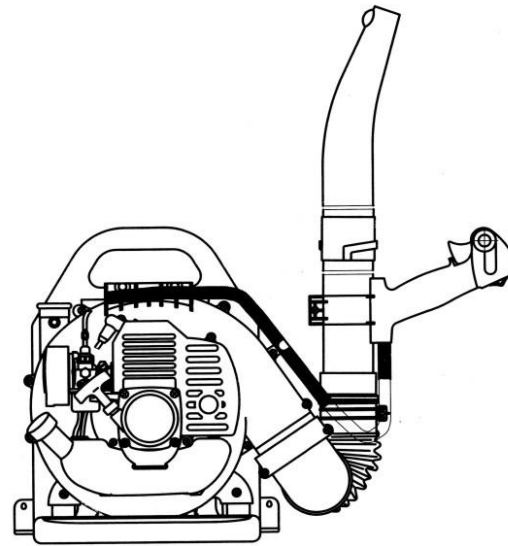

**EB808**

**CE**

## Guide to Using this Manual

### Pictograms

All the pictograms attached to the machine are shown and explained in this manual. The operating and handling instructions are supported by illustrations.

### Symbols in text

The individual steps or procedures described in the manual may be marked in different ways:

- Step or procedure without direct reference to an illustration.

Description of step or procedure that refers directly to the illustration and contains item numbers that appear in the illustration.

Example:

Loosen the screw (1)

Lever (2) ...

In addition to the operating instructions, this manual may contain paragraphs that require your special attention. Such paragraphs are marked with the symbols described below:

 Warning where there is a risk of an accident or personal injury or serious damage to property.

 Warning where there is a risk of damaging the machine or individual components.

 Note or hint which is not essential for using the machine, but may improve the operator's understanding of the situation and result in better use of the machine.

 Note or hint on correct procedure in order to avoid damage to the environment.

### \* Equipment and features

This instruction manual refers to several models with different features. Components that are not installed in all models and related applications are marked thus. Such components are available as special accessories from your dealer.

### Engineering improvements

Philosophy is to continually improve all of its products. As a result, engineering changes and improvements are made from time to time. If the operating characteristics or the appearance of your machine differ from those described in this manual, please contact your dealer for assistance.

Therefore, we cannot be responsible for changes, modifications or improvements not covered in this manual.

## Safety Precautions



Special safety precautions must be observed when working with the power tool.



It is important that you read, fully understand and observe the following safety precautions and warnings.

**Careless or improper use of any blower may cause serious or fatal injury.**

Have your dealer show you how to operate your blower. Observe all applicable local safety regulations, standards and ordinances.

**Minors should never be allowed to use a blower.**

Bystanders, especially children, and animals should not be allowed in the area where a blower is in use.

The operator is responsible for avoiding injury to third parties and damage to their property.

Do not lend or rent your blower without the owner's manual. Be sure that anyone using your blower understands the information contained in this manual.

**You must be fit to work with a blower**

- Rested, healthy and in good physical and mental condition
- If you get tired, take a break in good time
- Do not operate the blower if you are under the influence of any substance (drugs, alcohol, etc.) which might impair vision, dexterity or judgment.

**Only attachments supplied are expressly approved for use with your specific model are authorized.**

Other attachments must not be used because of the increased risk of accidents.

Excludes all liability for personal injury and damage to property caused while using unauthorized attachments.

**Wear proper clothing and equipment**



Clothing must be sturdy and snug-fitting, but allow complete freedom of movement - a safety coverall is recommended.



Avoid loose-fitting jackets, scarfs, neckties, jewelry, flared or cuffed pants, unconfined long hair or anything that could get into the air intake.



Wear sturdy boots with nonslip soles. Steel-toed safety boots are recommended.



**Wear safety glasses, goggles or a face shield.**

Wear sound barriers (ear plugs or ear muffs) to protect your hearing.



Wear heavy-duty, nonslip gloves, preferably made of chrome leather.

**Always shut off the engine before refueling.**



**Gasoline is an extremely flammable fuel. Do not smoke or bring any fire or flame near the fuel.**

Do not fuel a hot engine - fuel may spill and cause a fire.

Remove the fuel filler cap on the unit carefully so as to allow any pressure build-up in the tank to release slowly.

Fuel your blower, in well-ventilated areas, outdoors only. Wipe off any spilled fuel before starting and check for leakage. Take care not to get fuel on your clothing. If this happens, Change immediately.



Unit vibrations can cause an improperly tightened fuel cap to loosen or come off and spill quantities of fuel.

In order to reduce risk of fuel spillage and fire, tighten fuel cap as specified.

On units with a screw cap: Tighten the cap by hand with as much force as possible. On units with hinged handle on the fuel cap: Tighten as described in chapter "Fueling".

Check for fuel leakage while refueling and during operation. If fuel leakage is found, do not start or run the engine until leak is fixed.

Store gasoline and oil in properly labelled, approved safety-type cans.

**Transporting the unit**

Always stop the engine.

Transporting in a vehicle: Properly secure your unit to prevent turnover, fuel spillage and damage. When the unit is not in use (work break), put it down so that it does not endanger others.

**Before starting**

Check the following points:

- Throttle trigger must move freely and spring back to idle position when released.
- Stop switch must move easily to "OFF"
- Tightness of spark plug boot-if boot is loose, sparks may occur and ignite the escaping fuel vapor!

**Starting**

- Start the engine at least 3 m (10 ft) from the fueling spot, outdoors only.
- To reduce the risk of breathing toxic fumes, never start or run your unit in confined spaces.
- Place the unit on firm ground in an open area.
- Make sure you have good balance and secure footing.
- Hold the unit securely.

Your blower is a one-person unit. Do not allow other persons to be near the running unit - even when starting.

For specific starting instructions, see chapter "Starting" in the owner's manual.

#### During operation



#### Warning!

Your blower produces toxic exhaust fumes as soon as the engine is running. These gases

(e.g. carbon monoxide) may be colorless and odorless. To reduce the risk of serious or fatal injury from breathing toxic fumes, never run the blower indoors or in poorly ventilated locations.

Ensure proper ventilation when working in trenches, hollows or other confined areas.



To reduce the risk of igniting highly combustible fuel vapor and causing a fire, never smoke while working with or standing next to the blower.

Always hold your unit firmly- make sure you always have a firm and secure footing.

Examine the work area: Do not direct

the air blast towards bystanders

since the air flow can blow small objects at great speed.

#### Take care in slippery conditions

- On ice, in wet or snow
- On slopes or uneven ground

#### Watch out for obstacles:

Roots, ditches, holes or rubbish which could cause you to trip or stumble.

#### Spraying attachment

⚠ In the interests of the general public and the environment it is essential to observe all general safety regulations when handling and using plant protection products and other chemicals.

Follow the safety precautions and instructions given by the manufacturer of the plant protection products.

Change clothing immediately if it becomes soaked with plant protection chemical or spray solution.

⚠ To reduce the risk of inhaling poisonous fumes from chemicals and exhaust gases, do not operate the mistblower in confined spaces. Always wear a respirator when working in well-ventilated greenhouses, in dense, high stands and performing any work with dangerous dusting chemicals. Be alert to the wind direction. Do not work into the wind. Walk forwards only when the unit is running.

After finishing work, drain and clean the container. Do not empty residual spray solution or flushing fluids into waterways, gullies, sinks, drainage ditches or shafts. Dispose of properly in accordance with local waste disposal regulations.

Always drain and clean the container before transporting the mistblower in a vehicle.

⚠ In an emergency, release the quick-action buckles, slip out of the harness and throw off the machine.

#### Vibrations

Prolonged use of the unit may result in vibration-induced circulation problems in the hands (whitefinger disease).

No general recommendation can be given for the length of usage because it depends on several factors.

The period of usage is prolonged by:

- Hand protection (wearing warm gloves)
- breaks

The period of usage is shortened by:

- Any personal tendency to suffer from poor circulation (symptoms: frequently cold fingers, itching).
- Low outside temperatures.
- Gripping force (a tight grip hinders circulation).

Continual and regular users should monitor closely the condition of their hands and fingers. If any of the above symptoms appear, seek medical advice.

#### Maintenance and repairs

Do not attempt any maintenance or repair work not described in your owner's manual.

Have such work performed at your service shop only.

Never modify your power tool in any way as this could result in serious injury.

**Always stop the engine and disconnect the spark plug boot before doing any maintenance or repair work or cleaning the machine.**

Exception: Carburetor and idle adjustments.

Always clean dust and dirt off the machine after finishing work.

**Do not service or store your unit near any fire or flame!**

- Check fuel cap regularly for leaks.
- Use only an approved spark plug (see Specifications) and make sure it is in good condition.
- Inspect ignition lead (insulation in good condition, secure connection).
- To reduce the risk of fire due to ignition outside the cylinder, move the stop switch to **OFF** or **ON** before turning the engine over on the starter with the spark plug boot removed or the spark plug unscrewed.
- Check condition of muffler periodically.
- To avoid **risk of fire and hearing loss**, do not operate your unit if the muffler is damaged or missing.
- Never touch a hot muffler or burn will result.

#### Assembling the Unit

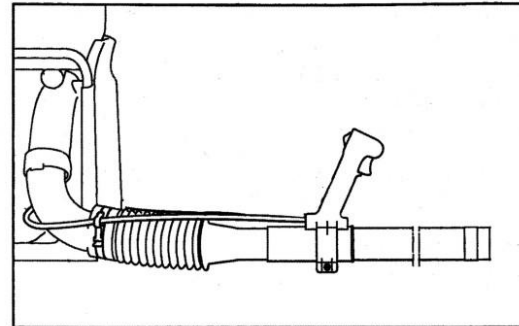

### Mounting the spraying attachment

- Push the extension tube into the pleated hose as far as it will go.
- Rotate the tube to the left (counter-clockwise) as far as stop and leave it in that position until you have completed the following adjustments.
- Turn the control handle counterclockwise to the horizontal position.
- Now rotate the extension tube counterclockwise until the metering unit points in the same direction as the control handle.
- Tighten down clamp screw (see "Adjusting the control handle").
- Attach liquid hose to the pleated hose with the retainer .

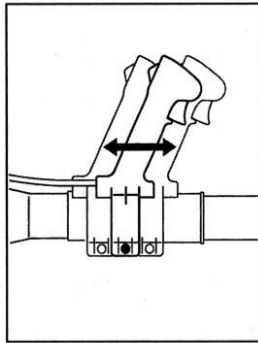
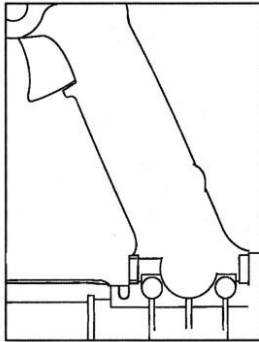

- Push the free end of the liquid hose over the stub on the stop cock and secure in position with the hose clip .
- Close the stop cock (move lever to vertical position).
- Fill up with water and check all hose connections for leaks.

### Adjusting the control handle

- Put the unit on your back.
- Release the clamp screw .
- Slide the control handle along the pleated hose to the most comfortable position.
- Retinhten the clamp screw .

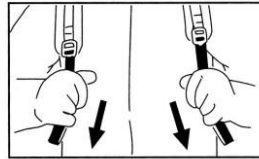

### Adjusting the harness straps

- Pull the ends of the straps downward to tighten the harness.

### Fuel

Your engine requires a mixture of gasoline and engine oil. The quality of these constituents and the mix ratio have a decisive influence on the function and scervice life of the engine.

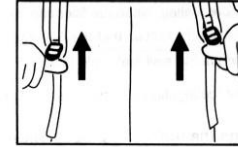

### Loosening the harness straps

- Lift the tabs of the two sliding adjusters.
- Adjust the straps so that the backplate is held firmly and comfortably against your back.

⚠ Unsuitable fuels or lubricants or mix ratios other than those specified may result in serious damage to the engine (piston seizure, rapid rate of wear, etc.).

### Gasoline

Use only regular branded gasoline with a minimum octane rating of 90. If the octane rating of the regular grade gasoline in your area is lower, use premium fuel - leaded or unleaded.

⚠ For health and environmental reasons, you should give preference to unleaded gasoline.

If your machine is equipped with a **catalytic converter**, you must use **unleaded gasoline**.

⚠ A few tankfuls of leaded gasoline will greatly reduce the efficiency of the catalytic converter.

### Engine oil

Use only quality two-stroke engine oil.

Other quality two-stroke engine oils must conform to classification TC.

⚠ Poor quality gasoline or engine oil may damage the engine, sealing rings, hoses and the fuel tank.

### Mixing fuel

⚠ Avoid direct skin contact with gasoline and avoid inhaling gasoline vapour.

- Use a canister approved for storing fuel. Pour oil (1) into the canister first, then add gasoline (2) and mix thoroughly.

### Mix ratio

Two-stroke engine oils (classification TC): 25 parts gasoline to 1 part oil

### Fueling



### Storing fuel

Fuel mix ages:

Only mix sufficient fuel for a few months work. Store in approved safety-type fuel canisters in a dry and safe location.

- Thoroughly shake the mixture in the canister before fueling your machine.
- ⚠ Pressure may build up in the canister - open it carefully.
- Clean the fuel tank and canister from time to time.
- ⚠ Dispose of cleaning fluid properly at authorized disposal location.

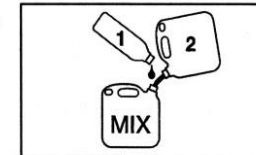

- Before fueling, clean the filler cap and the area around it to ensure that no dirt falls into the tank.
- Position the unit so that the filler cap is facing up.

Take care not to spill fuel while fueling and do not overfill the tank.

 After fueling, tighten down filler cap by hand as securely as possible.

#### Change the fuel pickup body once every year

- Drain the fuel tank.
- Use a hook to pull the fuel pickup body out of the tank and take it off the hose.
- Push the new pickup body into the hose.
- Place the pickup body in the tank.

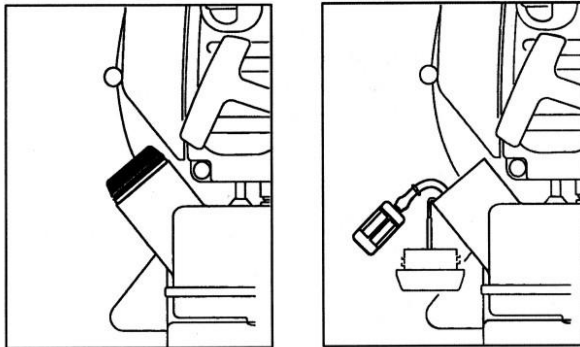

see "Guide to Using this Manual"

#### Starting / Stopping the Engine

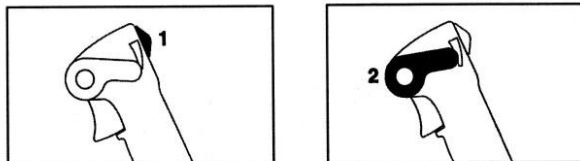

8

- Observe safety precautions - see chapter "Safety Precautions".

- Slide the stop switch (1) to ON

- Move the setting lever (2) to the center position - **this is the starting throttle position**

#### Note:

The setting lever can be used to select any throttle opening between idle speed (lower stop) and full throttle (upper stop).

Set the lever to idle position before switching off the engine.

#### Before starting

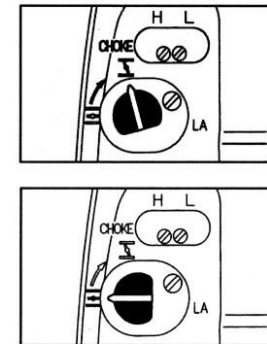

- If the engine is cold, turn the choke knob to **I**
  - If the engine is warm, turn the choke lever to **II**
- Also use this position if the engine has been running but is still cold.

- Put the unit on the ground. Check that bystanders are well clear of the general work area and the nozzle.
- Make sure you have a firm footing: Hold the unit with your left hand on the housing and put one foot against the base plate to prevent it slipping.
- Pull the starter grip slowly with your right hand until you feel it engage and give it a brisk strong pull. Do not pull the starter rope out all the way as it might otherwise break.
- Do not let the starter grip snap back.

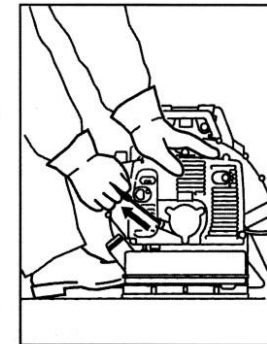

9

- Guide it slowly back into the housing so that the starter rope can rewind properly.

**When engine begins to fire:**

- If engine is **cold**:  
Turn choke knob to  and continue cranking until engine runs.
- If engine is **warm**:  
Continue cranking until engine runs.

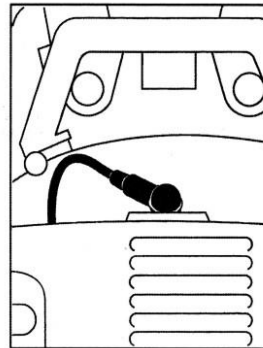
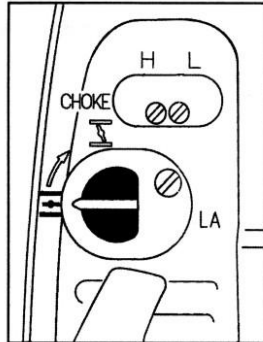
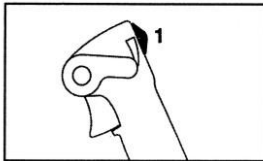
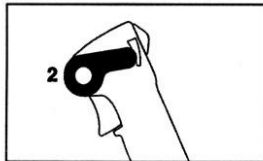

**As soon as engine runs:**

- Move the setting lever (2) to the lower stop so that the engine settles down to idle speed.

**To shut down the engine:**

- Slide the stop switch (1) to **OFF**

**At very low outside temperatures: Allow engine to warm up**

**As soon as engine runs:**

- Move the setting lever to the lower stop - the engine settles down to idle speed.
- Open throttle slightly - warm up engine for a short period.

**If the engine does not start:**

If you did not turn the choke knob to  quickly enough after the engine began to fire, the combustion chamber is flooded.

- Pull off the spark plug boot.
- Unscrew and dry off the spark plug.

- Set the stop switch to **OFF**
- Open the throttle fully.
- Pull the starter rope several times to clear the combustion chamber.
- Fit the spark plug and reconnect the spark plug boot.
- Move the stop switch to **ON**
- Turn the choke knob to  even if the engine is cold.
- Now start the engine.

**Fuel tank run until dry and then refueled**

- Pull the starter rope several times to prime the fuel line.

**Operating Instructions**

**During break-in period**

A factory new machine should not be run at high revs (full throttle off load) for the first three tank fillings. This avoids unnecessary high loads during the break-in period. As all moving parts have to bed in during the break-in period, the frictional resistances in the engine are greater during this period. The engine develops its maximum power after about 5 to 15 tank fillings.

**During operation**

After a long period of full-throttle operation, allow engine to run for a while at idle speed so that the heat in the engine can be dissipated by flow of cooling air. This protects engine-mounted components (ignition, carburetor) from thermal overload.

**After finishing work**

**Storing for short period:**

Wait for engine to cool down. To avoid condensation, fill the fuel tank and keep the unit in a dry place until you need it again. Storing for a long period: see chapter "Storing the Machine".

**Cleaning the Air Filter**

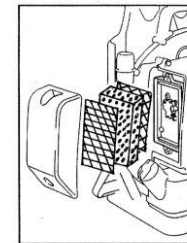
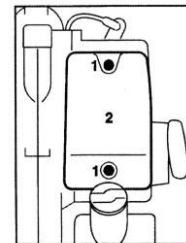

Dirty air filters reduce engine power increase fuel consumption and make starting more difficult.

**If there is a noticeable loss of engine power**

- Turn choke knob to **I**
- Release the screws (1) and pull off the filter cover (2).
- Remove the filter from the cover and inspect it - if it is dirty or damaged, clean the filter or fit a new one.
- Install the main filter and prefilter elements in the filter cover.
- Fit the cover on the filter base and tighten it down firmly.

**Carburetor**

**General Information**

Your carburetor comes from the factory with a standard setting.

This setting provides an optimum fuel-air mixture under most operating conditions.

The high speed screw alters the engine's power output and the maximum off-load engine speed.

 If the setting is too lean there is a risk of engine damage due to insufficient lubrication and overheating.

**Standard Setting**

**Carburetor with limiter caps**

- Shut off the engine.
- Screw down the high speed screw (H) and low speed screw (L) counterclockwise as far as stop (no more than 1/4 turn).

**Carburetor without limiter caps**

- Shut off the engine.
- Carefully screw both adjusting screws down onto their seats (clockwise).
- Open the high speed screw (H) one full turn.
- Open the low speed screw (L) one full turn.

**Adjusting Idle Speed**

**Engine stops while idling**

- Carry out standard setting on low speed screw.
- Turn the idle speed screw (LA) clockwise until the engine runs smoothly.

**Erratic idling behavior, poor acceleration**

- Carry out standard setting on low speed screw.
- Turn low speed screw (L) counterclockwise until the engine runs and accelerates smoothly.

It is usually necessary to change the setting of the idle speed screw (LA) after every correction to the low speed screw (L).

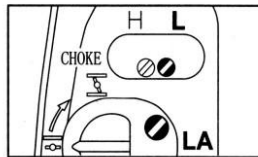
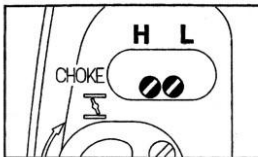
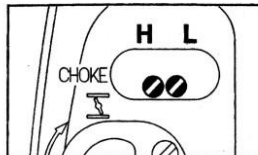

**Fine Tuning for Operation at High Altitude**

A slight correction of the setting may be necessary if engine power is not satisfactory when operating at high altitude:

- check the standard setting.
- Warm up the engine.
- Turn the high speed screw (H) slightly clockwise (leaner). On models with limiter caps, turn high speed screw (H) 1/4 turn, but no further than stop.

 If the setting is too lean there is a risk of engine damage due to insufficient lubrication and overheating.

**Checking the Spark Plug**

If engine is down on power, difficult to start or runs poorly at idle speed first check the spark plug.

- Remove the spark plug - see "Starting / Stopping the Engine"
- Check electrode gap (A) and readjust if necessary - see "Specifications".

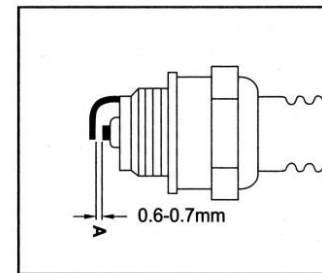

Rectify the problems which have caused fouling of spark plug:

- Too much oil in fuel mix.
- Dirty air filter.
- Unfavorable running conditions.

Fit a new spark plug after about 100 operating hours - or sooner if the electrodes are badly eroded.

**To reduce the risk of arcing and fire:**

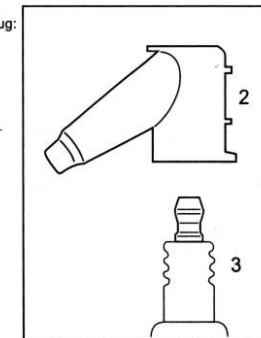
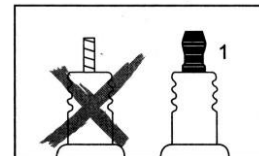



- If the spark plug comes with a detachable adapter nut (1), screw it on firmly.  
On all spark plugs:
- Always press the boot (2) firmly on to the spark plug (3).

### Engine Running Behavior

If engine running behavior is unsatisfactory even though the air filter is clean and the carburetor properly adjusted, the cause may be in the muffler.

Have the muffler checked for contamination (coking) by dealer.

### Replacing Starter Rope and Rewind Spring

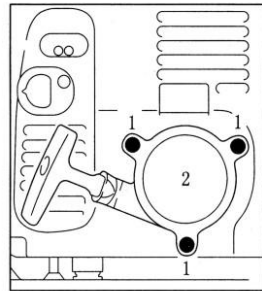

#### Replacing the starter rope

- Remove the screws (1).
- Take the starter cover(2) off the engine.

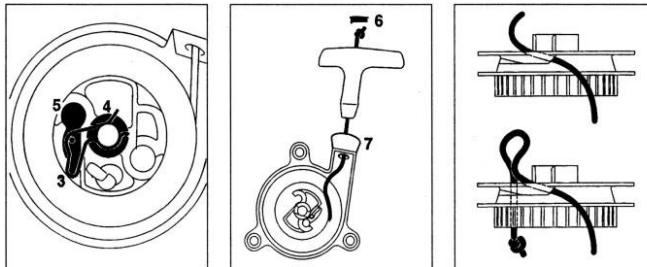

- Remove the spring clip (3).
- Remove the rope rotor with washer (4) and pawl (5).
- Ease the cap (6) out of the starter grip.
- Remove remaining rope from the rotor and grip.
- Tie a simple overhand knot in the end of the new starter rope (see Specifications) and then thread the rope through the top of the grip and the rope bush (7).
- Refit the cap in the grip.
- Thread the rope through the rotor and secure it in the rotor with a simple overhand knot.

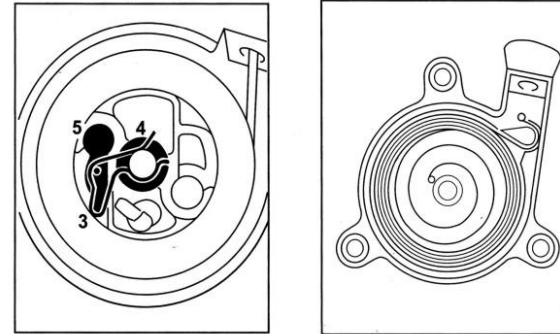

- Fit the pawl (5) in the rotor and slip the washer (4) over the starter post.
- Use a screwdriver or suitable pliers to install the spring clip (3) on starter post and over the peg on the pawl-the spring clip must point clockwise - see illustration.  
Go to "Tensioning rewind spring".

#### Replacing a broken rewind spring

- Lubricate the new spring with a few drops of non-resinous oil.
- Remove the rope rotor as described in "Replacing the starter rope".
- Remove parts of old spring.
- Fit new spring housing - bottom plate must face downward. Engage outer spring loop over the lug.
- Refit the rope rotor.  
Go to "Tensioning rewind spring".

If the spring pops out and uncoils during installation: Refit it in the spring housing in the counter-clockwise direction - start outside and work inward.

#### Tensioning rewind spring

Make a loop in the unwound starter rope and use it to turn the rope rotor six full revolutions in the direction of the arrow (see illustration).

- Make a loop in the unwound starter rope and use it to turn the rope rotor six full revolutions in the direction of the arrow (see illustration).
- Hold the rotor steady - straighten the twisted rope.
- Release the rotor and let go of rope slowly so that it winds onto the rotor.
- The starter grip must sit firmly in the rope guide bush. If the grip droops to one side: Increase spring tension by one additional turn.

When the starter rope is fully extended it must be possible to rotate the rotor at least another half turn. If this is not possible, the spring is overtensioned and could break. Take one turn of the rope off the rotor.

- Fit the starter cover on the enging.
- Tighten down the screws firmly.
- Move the stop switch to **OFF**

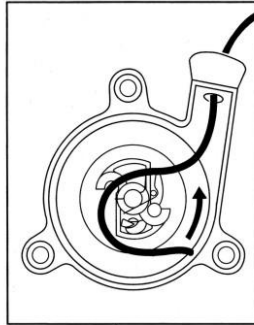

### Storing the Machine

#### For periods of about 3 months or longer

- Drain and clean the fuel tank in a well ventilated area.
- Drain and clean the container.
- Run engine until carburetor is dry - this helps prevent carburetor diaphragms sticking together.
- Thoroughly clean the machine - pay special attention to the cylinder fins and air filter.
- Store the machine in a dry, high or locked location - out of the reach of children and other unauthorized persons.
- Do not expose the container to direct sunlight for unnecessarily long periods. UV rays can make the container material brittle, which could result in leaks or breakage.

### Maintenance Chart

The following maintenance intervals apply to normal operating conditions only. If your daily working time is longer than normal or operating conditions are difficult (very dusty work area etc.), shorten the specified intervals accordingly.

		before starting work	after finishing work or daily	after each refueling stop	weekly	monthly	every 12 months	if problem	if damaged	if required
Complete machine	Visual inspection (condition, leaks)	x		x						
	Clean		x							
Control handle	Check operation	x		x						
	Clean							x		
Air filter	Replace								x	
	Check							x		
Filter in fuel tank	Replace									x
	Clean					x				
Carburetor	Check idle setting	x		x						
	Readjust idle									x
Spark plug	Readjust electrode gap							x		
Cooling air intakes	Clean				x					
Spark arresting screen in muffler	Check							x		x
	Clean or replace									
All accessible screws and nuts (not adjusting screws)	Tighten									x
Container with hose	Visual inspection (condition, leaks)	x								
Metering unit	Check							x		
Anti-vibration elements	Visual inspection	x								
	Have replaced by dealer							x	x	

### Minimize Wear and Avoid Damage

Observing the instructions in this manual helps reduce the risk of unnecessary wear and damage to the power tool.

The power tool must be operated, maintained and stored with the due care and attention described in this owner's manual.

The user is responsible for all damage caused by non-observance of the safety precautions, operating and maintenance instructions in this manual. This includes in particular:

- Alterations or modifications to the product not approved by dealer.
- Using attachments, Power Tool Attachments or cutting tools not approved by dealer.
- Using the product for purposes for which it was not designed.
- Using the product for sports or competitive events.
- Consequential damage caused by continuing to use the product with defective components.

### Maintenance Work

All the operations described in the "Maintenance Chart" must be performed on a regular basis. If these maintenance operations cannot be performed by the owner, they should be performed by an authorized servicing dealer.

If these operations are not carried out as specified, the user assumes responsibility for any damage that may occur. Among other things, this includes:

- Damage to the engine due to neglect or deficient maintenance (e.g. of air and fuel filters), incorrect carburetor adjustment or inadequate cleaning of cooling air inlets (intake ports, cylinder fins).
- Corrosion and other consequential damage resulting from improper storage.
- Damage and consequential damage resulting from the use of parts other than original replacement parts.
- Damage resulting from maintenance or repair work performed by authorized servicing dealers.

### Parts Subject to Wear and Tear

Some parts of the power tool are subject to normal wear and tear even during regular operation in accordance with instructions and, depending on the type and duration of use, have to be replaced in good time.

Among other parts, this includes:

- Filters (air, fuel)
- Fanwheel
- Starter mechanism
- Spark plug
- Components of anti-vibration system

## Specifications

Single cylinder two-stroke engine  
 Displacement: 42.7 cm<sup>3</sup>  
 Bore: 40 mm  
 Stroke: 34 mm  
 Idle speed: 2800 rpm  
 Engine power: 1.25kw  
 Weight: 9.5 kg  
 Air flow rate: 720 m<sup>3</sup>/h

## Fuel System

Carburetor: All position diaphragm carburetor with integral fuel pump  
 Fuel filter: Felt and Steel wire filter  
 Fuel tank capacity: 1.2L  
 Fuel mix: see chapter "Fuel"

## Ignition System

Type: Electronic magneto ignition  
 Spark plug (suppressed): L7T  
 Spark plug electrode gap: 0.5 mm  
 Spark plug thread: M 14 x 1.25; 9.5 mm long

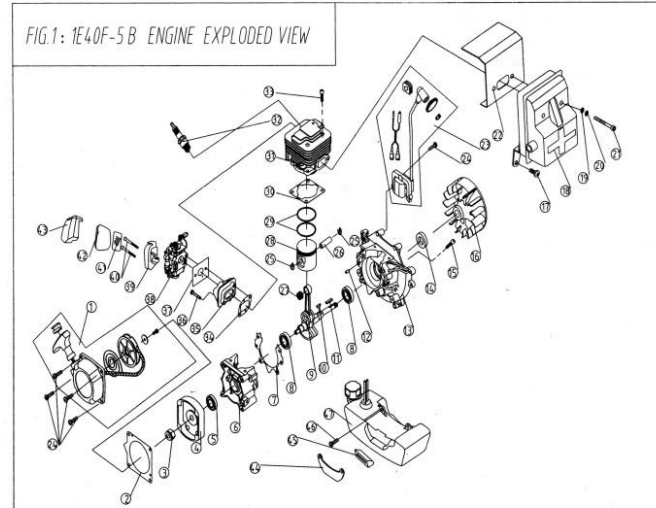

Se.No.	Part No.	Part Name	Qty	Se.No.	Part No.	Part Name	Qty
1	3WF-808 14.1	easy starter	1	24	GB/T19074.4-MSX20	screw asm	2
2	1E40F-5-10	gasket	1	25	1E40F-3.2-2	ring	2
3	GB/T6170-M8	nut	1	26	JAE40F-5A	piston pin	1
4	3WF-808 14.2	starter pulley	1	27	1E40F-5.4-2	10X13X15.5bearing	1
5		112X22X7sealing	1	28	1E40F-5.4-1	piston	1
6	1E40F-5.8-2	back crankcase	1	29	1E40FP-32.3-5	piston ring	1
7	1E40F-5.8-4	crank gasket	1	30	1E40F-5-6	cylinder gasket	1
8	GB/T2716-6202/PS	bearing	2	31	1E40F-5-4	cylinder	1
9	1E40F-5P.2	crank shaft	1	32	L7T	spark plug	1
10	GB/T10999-3X5x13	key	1	33	70.1PS-MSX20	screw	4
11	3x18	key	1	34	1E40F-5-2	admitting gasket	1
12	GB/T119-84X10	pin	2	35	1E40F-5A.2	admitting flange	1
13	1E40F-5.8-1	front crankcase	1	36	GB/T19074.4-MSX25	screw asm	2
14		15X30X7 sealing	1	37	1E40F-5A-1	carburetor gasket	1
15	70.1PS-MSX30	screw asm	4	38	1E40F-5A.8	carburetor	1
16	40F-5P.6-01	fly wheel	1	39	1E36F-8A.2.1	inside cover	1
17	GB/T19074.4-MSX12	screw asm	1	40	GB/T19074.4	MSX50 screw	2
18	1E40F-5.2	muffler	1	41	1E36F-8A.2-3	net board	1
19	GB/T195-6	washer	2	42	1E36F-8A.2-2	filter	1
20	GB/T193-6	washer	2	43	1E36F-8A.2-1	outside cover	1
21	GB/T770.1-M6X55	screw	2	44	1E40F-5A-4	stand	1
22	1E40F-5P.3	muffler gasket	1	45	1E40F-5A-2	rubber cover	1
23	1E40F-5.3A	oil	1	46	GB/T19074.4-MSX16	screw asm	2
				47	1E40F-7A.1	fuel tank asm	1

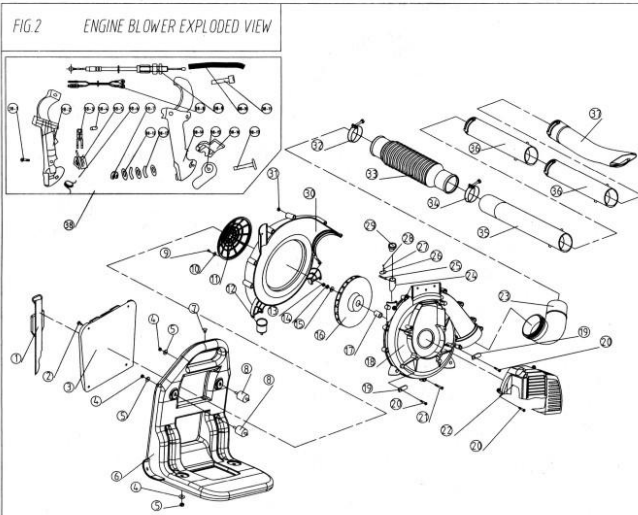

Qty	Part No.	Part Name	Qty	Part No.	Part Name	Qty
1	3WF18-3-05-04	belt comp	1	31	GB/T6170-M5	nut
2	3WF-2.6B-2	clip	5	32	3WF-3.19.5	clip asm
3	3WF-3.11	back mat	1	33	ZB4-5-2	hose
4	GB/T6177.1-M6	nut	4	34	3WF-2.6A.4.1	clip asm
5	GB/T96.2-6	washer	4	35	3WF-2.6	pipe
6	EB808-2	frame	1	36	3WF-2.6	pipe
7	3WF18-3-2	rubber plug	1	37	EB808-3	pipe
8	3WF-2.6A.6	rubber pillar	2	38	EB808	handle asm
9	GB/T845-S14.2X13	screw	3	38-1	GB/T845-S14.2X16	screw
10	GB/T96.2-4	washer	3	38-2	3WF-808.15-1	right box
11	3WF-2.6.9-1	net cover	1	38-3	3WF-808.15-8	switch spring
12	3WF-808.4	rubber support	2	38-4	3WF-808.15-9	pipe
13	GB/T6170-M10	nut	1	38-5	3WF-808.15-7	switch
14	GB/T93-10	washer	1	38-6	3WF-808.15-6	spring
15	GB/T97.1-12	washer	1	38-7	GB/T896-4	stop ring
16	3WF-808.6-03	fly wheel	1	38-8	3WF-808.17	wire
17	1E40F-5P.4	lub e	1	38-9	EB808.1	fuel throttle
18	3WF-808.6-02	valute case	1	38-10		pipe
19	1E40F-3A.9	clip	2	38-11	GB/T845-S14.8X25	screw
20	GB/T845-S14.8X20-F-H	screw	6	38-12	GB/T96.2-6	washer
21	GB/T818-M5x30	screw	14	38-13	3WF-808.15-5	washer
22	3WF-808.1	cover	1	38-14	3WF-808.15-2	left box
23	3WF-2.6	fan joint	1	38-15	3WF-808.15-4	lock shaft
24	3WF18-3	pipe	1	38-16	3WF-808.15-10	handgrip
25	3WF18-3	shaft	1	38-17	3WF-808.15-3	shaft
26	3WF18-3	board	1			
27	GB/T97.1	Ø3 washer	2			
28	GB/T845	3x8 screw	2			
29	EB808-1	plug	1			
30	3WF-808	valute case	1			