

iRobot[®]

Braava[™]

Floor Mopping Robot

300 Series Owner's Manual

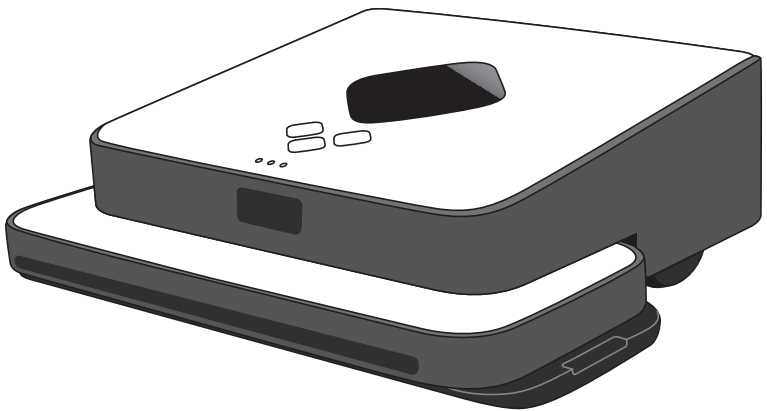

global.irobot.com

Welcome



Dear iRobot® Braava™ Owner,

Welcome to the world of iRobot. As an owner of the iRobot Braava Floor Mopping Robot, you join a growing group of people around the globe who, like you, are discovering an easier way to mop their floors.

The use of practical robots that help you in and around your home is a new reality. We encourage you to share your feedback as we continue to develop new and groundbreaking robots. Here's what you can do to participate in our efforts:

- Communicate with us if you have questions, comments or require support. Contact us at **global.irobot.com**.

Thank you for joining the robot revolution. We look forward to your valued input as we continue to deliver groundbreaking products that will change and improve your world.

On behalf of the entire iRobot team,



A handwritten signature in black ink, appearing to read "Colin Angle".

Colin Angle
Co-Founder and CEO
iRobot Corporation

Table of Contents

Safety Instructions.....	4
Braava Overview	8
Buttons and Lights	10
Battery and Charging	12
Sweep and Mop Modes.....	14
How Braava Cleans.....	16
NorthStar® Navigation	18
Operating Braava	20
Maintenance.....	24
Trouble Shooting	26
Customer Support.....	30

IMPORTANT SAFETY INSTRUCTIONS TO REDUCE THE RISK OF FIRE, ELECTRIC SHOCK, OR INJURY

⚠ CAUTION: Do not expose the electronics of Braava, its battery or the adapter. There are no user-serviceable parts inside. Refer servicing to qualified service personnel.

WARNING: READ AND SAVE THESE INSTRUCTIONS.

To avoid the risk of injury or damage, these basic precautions should always be followed:

- Read all safety and operating instructions before using Braava.
- Read and heed all warnings in this manual and on Braava, the Cube and the adapter.
- Only use Braava in accordance with the specifications outlined in this manual.
- Do not attempt to repair or adjust any electrical or mechanical functions on this device. Tampering with these functions may create a hazardous condition, and it will void your warranty.
- Be aware that floors may be slippery after wet cleaning with Braava.
- Braava operates very quietly. Take care when walking in the area Braava is cleaning to avoid stepping on Braava and tripping.

USE RESTRICTIONS

- Braava is not a toy. Supervise children and pets when Braava is cleaning.
- Braava has electrical parts. Do not spray, rinse or submerge it in water. Clean with a dry cloth only.
- Braava is for indoor use on hard surface floors only.
- Do not use Braava to pick up large debris, liquid spills, bleach, paint, or other chemicals.
- Do not use Braava near any objects that are burning or smoking.
- Before using Braava, remove fragile objects from the cleaning area, including objects on furniture that can fall if the furniture is pushed or bumped.
- Move any power cords as well as cords for blinds and curtains out of the way to reduce the risk of objects being pulled down.
- Block off access to open balconies near the cleaning area with physical barriers.
- Make sure the cleaning cloth does not drape into the middle channel between the gripping strips as this could impede sensor functions and safe operation. See page 18 for further detail.
- When mopping, do not use Braava in areas where wetness can damage unfinished or unsealed floors or delicate carpeting or rugs.
- Operate at room temperature. Do not expose Braava or its batteries to freezing or extreme heat.
- This appliance can be used by children aged from 8 years and above and persons with reduced physical, sensory or mental capabilities or lack of experience and knowledge if they have been given supervision or instruction concerning use of the appliance in a safe way and understand the hazards involved. Children shall not play with the appliance. Cleaning and user maintenance shall not be made by children without supervision.

BATTERY AND CHARGING

- Charge using a standard U.S. (120V AC) outlet only.
- Only use the included adapter to charge Braava. Braava 320 and 380t chargers are not cross-compatible.
- Only use rechargeable battery packs approved by the manufacturer.
- Do not use an adapter with a damaged cord or plug.
- Do not handle or charge Braava when hands are wet.
- Always disconnect Braava from the adapter before cleaning.

Notice: Braava contains a software interface for the purpose of enabling the manufacturer to provide updates to the internal firmware if any such updates are made available to users. Any attempt to access, retrieve, copy, modify, distribute or otherwise use any of the Braava software is strictly prohibited.

FCC Notice: This device complies with Part 15 of the FCC rules. Operation is subject to the following conditions:

1. The device may not cause harmful interference.
2. This device must accept any interference received, including interference that may cause undesired operation.

⚠ WARNING: Changes or modifications not expressly approved by iRobot could void your warranty.

This device complies with RSS-210 of the Industry Canada Rules. Operation is subject to the following two conditions: (1) This device may not cause harmful interference, and (2) this device must accept interference received, including interference that may cause undesired operation.

Braava Overview

Braava

- ① Control Buttons
- ② NorthStar® Navigation Sensor
- ③ Navigation System Indicator
- ④ Bumper
- ⑤ Handle
- ⑥ Cube on/off button (on back corner)
- ⑦ Removable Cleaning Pad

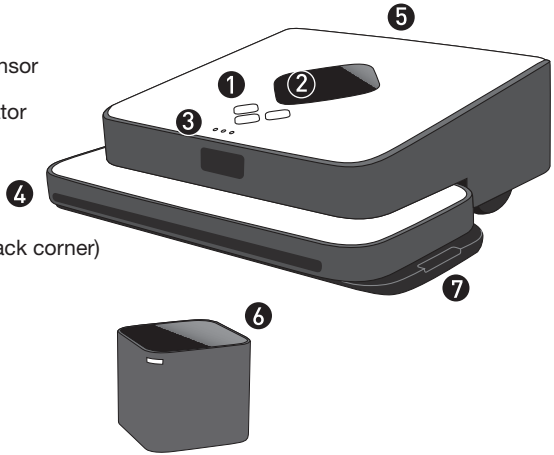

NorthStar® Navigation Cube

- ⑧ Battery Charging Port
- ⑨ Floor Transition Sensors
- ⑩ Wheel Guards
- ⑪ Charging Adapter

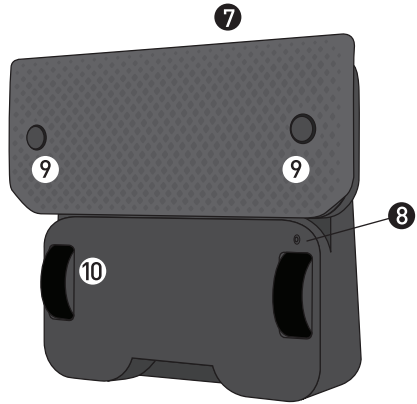
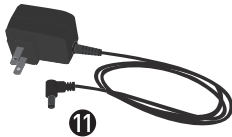

- ⑫ Turbo Charge Cradle (380t)

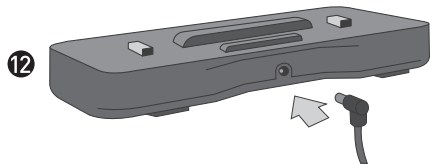

Multi-Purpose Cleaning Pad

For dry sweeping or wet mopping, disposable or reusable microfiber cloths.

- 13 Cloth Gripping Strips
- 14 Middle Channel for Floor Transition Sensors



Pro-Clean Reservoir Pad (Ships with Select Models)

For wet mopping with the blue Pro-Clean microfiber cleaning cloth.

- 15 Fill Cap
- 16 Reservoir
- 17 Wick

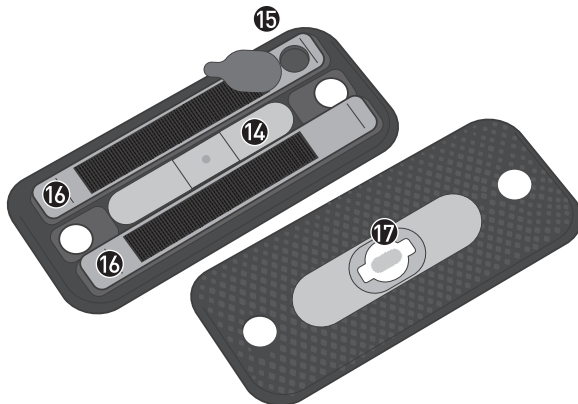

Buttons and Lights

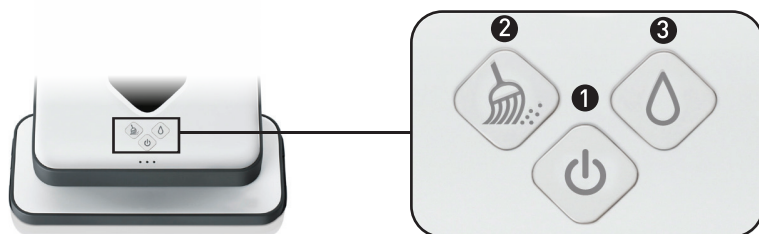

① Power Button

Press once to turn Braava on.
Hold for 2 seconds to turn Braava off.

Blue solid light: Power on

Red blinking light: Battery starting to get low

Red solid light: Low battery (needs to be recharged)

② Sweep Button

For use with dry cloths.

Press once to start cleaning.*
Press while cleaning to pause.

Blue solid light: Sweep mode activated

Blue blinking light: Sweep mode paused

③ Mop Button

For use with wet cloths.

Press once to start cleaning.*
Press while cleaning to pause.

Blue solid light: Mop mode activated

Blue blinking light: Mop mode paused

**Holding the cleaning mode button will activate Quick Clean Mode. See page 15.*

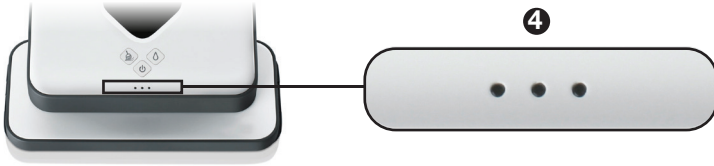

4 Navigation System Indicators

NorthStar Connection

Blue blinking light (1): Establishing connection

Blue solid light (1 to 3): Locked onto NorthStar Cube

The number of lights indicates the strength of Braava's connection to the navigation system, with 3 being strongest. If there are no lights, Braava does not detect a NorthStar signal.

Other States

Blue lights flashing in sequence: Thinking

Blue lights flashing with pause: Sleep mode

Red light in middle: Error*

**See trouble shooting section for more information.*

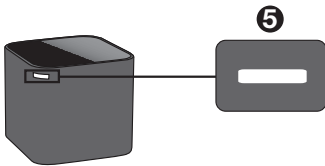

5 NorthStar® Navigation Cube Lights

Blue blinking light: Power on, broadcasting signal

Blue solid light: Power on, connected to Braava

Red solid light: Batteries low

Battery and Charging

	Mode	Braava 320	Braava 380t
Run Time	Sweep	up to 3 hrs	up to 4 hrs
	Mop	2 hrs	2.5 hrs
Charge Time	N/A	10 hrs	2 hrs

Charging

- Stand Braava on its end to access the charging port.
- Plug the adapter into a standard electrical outlet and into Braava's charging port.
- Charge Braava until a solid blue light appears on the power button*.
- It may take Braava a few charging cycles to reach its full capacity.

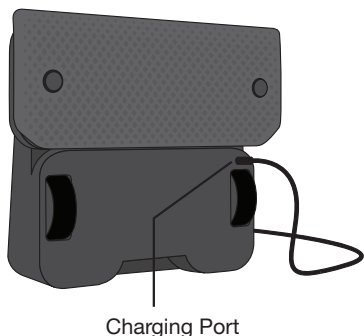

**The blue light indicates on average that the battery has charged to 80% of its capacity.*

Charging time and run time can be affected by operating temperature, floor type and other conditions.

TIP: Braava 380t can also be charged with the Braava Turbo Charge Cradle. See Cradle instructions for details (pg.11).

⚠ CAUTION: Do not charge Braava while the Pro-Clean reservoir pad or any wet cloth is attached. Charge using a standard 120V outlet only. Only use the included adapter to charge Braava. Always disconnect Braava from the adapter before cleaning.

Turbo Charge Cradle

(Compatible only with Braava 380)

- Plug the adapter into a standard electrical outlet and plug the other end of the cord into the power jack on the Cradle.
- One blue light will appear on the front of the Cradle.
- Place Braava on the Cradle to charge.
- Charge Braava for approximately 2 hours or until a solid blue light appears on Braava's power button.
- Remove Braava from the Cradle before applying cleaning cloths or the Pro-Clean Reservoir Pad.
- Charging time and run time can be affected by operating temperature, floor type and other conditions.

❶ Power Jack

❷ Charging Contacts

❸ LED indicator

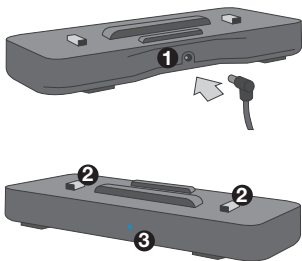

TIP: Braava's adapter is compatible with the Cradle and can be plugged into either Braava directly or into the Turbo Charge Cradle.

⚠ CAUTION: Do not charge Braava while the Pro-Clean reservoir pad or any wet cloth is attached. Charge using a standard outlet only. Only use the adapter included with the Braava 380t. See Braava manual for safety warnings and instructions.

Compatible only with the Braava 380t.

Charging Indicators

(While Plugged In)

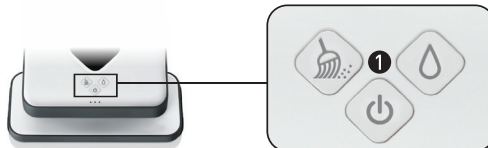

❶ Power Button

Red pulsing light: Battery charging

Blue solid light: Battery charged

The NorthStar Navigation Cube

The Cube uses 2 C batteries. The battery door can be found on the bottom of the Cube.

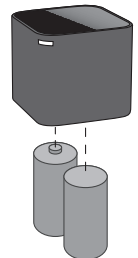

Please dispose of all batteries properly by finding a recycling resource near you.

Sweep and Mop Modes

Braava sweeps and mops hard surface floors using readily available dry and wet cleaning cloths or the included reusable microfiber cloths.

Braava is not a vacuum and is not intended for use on carpets.

Sweep Mode

Sweep mode is intended for cleaning with a *dry cloth*.

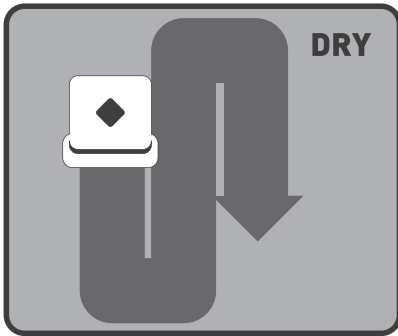

In Sweep mode, Braava moves ahead in a straight line when it begins cleaning, then cleans back and forth in parallel lines.

It is ideal for picking up dust, dirt and hair to maintain clean, grit-free floors every day.

Mop Mode

Mop mode is intended for cleaning with a *wet cloth*.

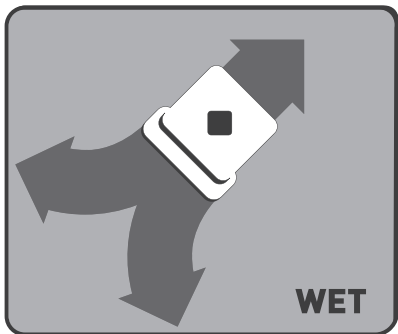

In Mop mode, Braava drives forward a short distance to one side, backs up slightly then moves forward to the other side, alternating to the left and right as it progresses.

This mopping action helps dissolve and pick up the deeper dirt and grime on your floors.

Braava automatically adjusts to a smaller cleaning area in Mop mode to optimize cleaning while the cloth is wet.

TIP: Start with dry Sweep mode to pick up surface grit and then follow with a wet cloth in mopping mode to get a deeper clean.

Cleaning Cloths

Disposable Cloths

For use only with the Multi-Purpose Cleaning Pad.

- Braava is compatible with most disposable dry and pre-moistened cleaning cloths such as Swiffer® brand and store brands like Target®.
- Always follow the use and care instructions included with any dry or wet cleaning cloths to care for your floors.
- Please note that Braava is not compatible with Swiffer® WetJet® Refills.

Microfiber Cloths

Braava's specially designed microfiber cloths can be rewashed and reused.

- White cloths are for dry sweeping with the Multi-Purpose Cleaning Pad.
- Blue textured cloths are for mopping and can be used with either the Pro-Clean Reservoir Pad or the Multi-Purpose Cleaning Pad. Dampen cloth before use.

⚠ NOTICE: Wet cloths may not be suitable for cleaning unsealed floors. Ask your flooring manufacturer or installer if you are unsure whether damp mopping is safe for your floor.

Floor Types

- Braava is designed to clean hard surface floors including wood, tile, vinyl, linoleum and laminate.
- Braava cleans best on smooth hard surfaces and may not perform on uneven tiles, heavily waxed floors or rough surfaces like slate or brick which can snag the cleaning cloth.

⚠ NOTICE: Braava is not intended to pick up large debris. Before cleaning with Braava, pick up large debris and check for gravel or sharp objects that could scratch the floor if captured under the cleaning pad.

How Braava Cleans

Braava intelligently cleans your floor by mapping the room as it cleans.

Cleaning Cycle

- Braava cleans your home in sections, first cleaning areas to its right and later returning to areas to its left.
- When the open areas in each section are complete, Braava cleans along edges of furniture and walls before moving on.
- When finished, Braava returns to where it started and parks itself.

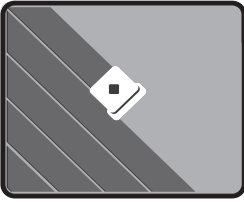

Cleaning Pattern

- In open areas, Braava methodically cleans back and forth across your floor.
- As Braava encounters chair legs, furniture and other obstacles, it cleans around them and continues its cleaning pattern.
- Braava detects stairs and will maneuver away from drop offs and back to the cleaning area.

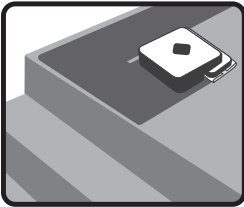

As a safety precaution, open ledges or balconies with a drop of 2 feet or more should be blocked off with a physical barrier.

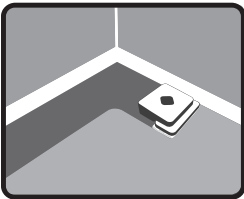

- Braava also detects area rugs and raised transitions to carpet so it can avoid driving on to them.
Note: If your carpet is flush with your hard surface floor, you may need to add a temporary barrier to provide Braava a boundary it can detect.
- Braava follows along walls and edges as it encounters them and as it completes each section it cleans.

Quick Clean Mode

- Cleans 30% faster by focusing cleaning on open areas.
- Activate by holding the Sweep or Mop button for 3 seconds.
- You will hear a single beep followed by the “start cleaning” song.
- Braava typically cleans the same total area as the standard detailed cleaning mode, but will skip detailed cleaning around furniture and some walls to save time.

Pause / Resume

Braava will automatically pause if you pick it up or press any button while cleaning.

- The cleaning mode button will flash blue to indicate the cleaning cycle is paused. While paused, Braava will save the map of the area it has already cleaned.
- To resume cleaning, place Braava within 6 feet of the Cube where it originally started, facing in the same general direction it started.
- Press the flashing cleaning mode button.
- Braava will start cleaning while it determines its position on the map. Once it confirms its position, it will drive to an area not yet covered and continue cleaning.
- Braava may re-clean an area already covered or explore new areas of cleaning while determining its position on the map.
- If you resume Braava where you paused it, it may take longer for the cleaner to determine its position depending on its distance from the Cube.
- To exit Pause and quit the cleaning cycle, power Braava off by holding the power button for 2 seconds.

Note: Braava can only be paused after it has locked onto the NorthStar Navigation Cube at the beginning of the cleaning cycle.

NorthStar® Navigation

The NorthStar Navigation Cube acts as a beacon, emitting a signal that guides Braava's cleaning.

Connecting to the NorthStar Navigation Cube

- Once Braava starts cleaning, it tries to establish a connection to the NorthStar Navigation Cube, indicated by one flashing blue light on the Navigation System Indicator. Once Braava has locked onto the Cube, Braava's lights turn solid blue.
- The Navigation System Indicator also indicates Braava's range. As Braava gets to the edge of its range (such as going out of the room or far from the NorthStar Navigation Cube) the number of lights will go down.
- Braava may occasionally drive back toward the NorthStar Navigation Cube to confirm its position before continuing on its cleaning path.
- Braava builds a new map each time it starts a new cleaning cycle, but retains its map if paused during the cleaning cycle.

Cleaning without a NorthStar Navigation Cube

- Because the Cube is just one part of the Navigation System, Braava can still clean without a NorthStar signal present, however the cleaning area will be much smaller and Braava will not be able to perform edge cleaning in each section.

Cleaning with multiple NorthStar Navigation Cubes: (For Braava 380t ONLY):

- Braava can use multiple NorthStar Cubes to clean up to 2,000 square feet when dry sweeping. Braava will move from one Cube to the next, extending the cleaning area with each Cube it encounters.
- Multiple cubes can be used in Mop mode, too, but Braava limits its wet cleaning area to 350 square feet to optimize for cloth wetness.

	Mode	Braava 320	Braava 380t
Coverage	Sweep	800 sq. ft.	1,000 sq. ft.*
	Mop	250 sq. ft.	350 sq. ft.

*up to 2,000 sq. ft. with additional NorthStar® Cube (sold separately)

Setting Up NorthStar Navigation Cubes

Using Braava with one Cube

- Place the Cube near the center of the area you want to clean and start Braava nearby.
- Braava will clean the area around the Cube, and may extend into other rooms based on the cleaning mode and how far the NorthStar signal reaches.
- If you have a choice of rooms, place the Cube in a larger room to maximize NorthStar coverage.
- Once Braava has completed its run, you can move the Cube to clean a different part of your home.

Using Braava with multiple Cubes (For Braava 380t ONLY):

- Use one or more extra Cubes (sold separately) to expand how far Braava cleans in a single run.*
- Place extra Cubes in rooms or areas next to the area covered by the first Cube. The Cubes should typically be between 20 and 25 feet from each other for the NorthStar coverage to overlap.
- Braava will automatically clean from one Cube to another.

*Cubes are pre-programmed to different NorthStar channels, indicated on the bottom of the Cube. Cubes with different channels must be used for multi-Cube cleaning.

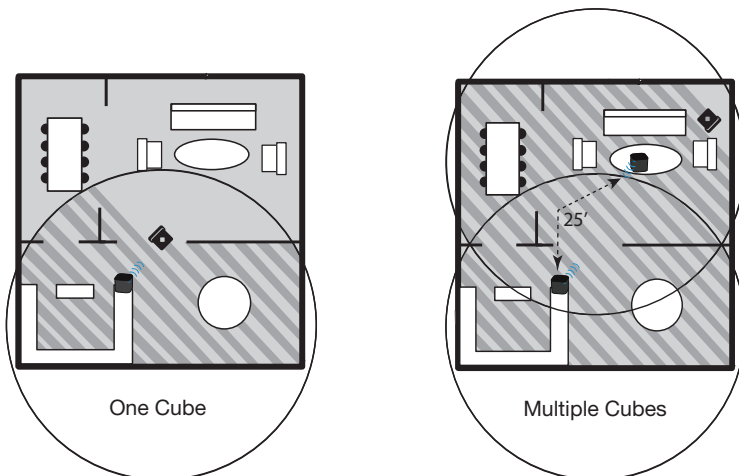

Operating Braava

Put On a Cleaning Cloth

1. Set Braava on its end and remove the cleaning pad.
2. Attach a dry or wet cloth to the Multi-Purpose cleaning pad. Lay the removable pad on an open cleaning cloth. Attach cloth by tucking it into the gripping strips on both sides. See the following page for the Pro-Clean Reservoir Pad.
3. Re-attach the cleaning pad. Magnets will help it snap back into place.

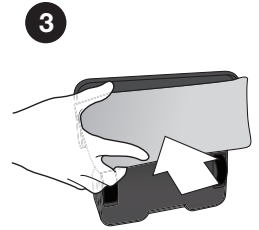
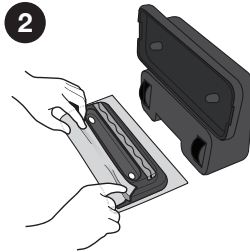
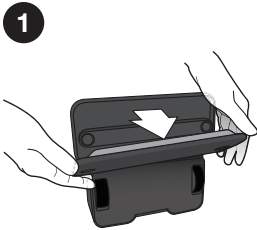

⚠ CAUTION: Make sure the cleaning cloth does not drape into the middle channel between the gripping strips as this could impede sensor functions and safe operation.

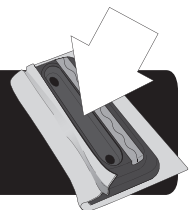

Using the Pro-Clean Reservoir Pad

(Sold separately for Braava 320)

The Pro-Clean Reservoir Pad dispenses liquid as Braava mops to keep the cleaning cloth wet longer.

Fill the reservoir

1. Open the fill cap by pulling and swiveling it to the side.
2. Fill reservoir with water and replace fill cap, pressing it in securely so it does not leak.
3. Fill the reservoir over a sink as a small amount of fluid can leak out when the fill cap is closed.
4. Dampen the blue Pro-Clean microfiber cloth and press onto the velcro strips. Do not use a dry cloth.

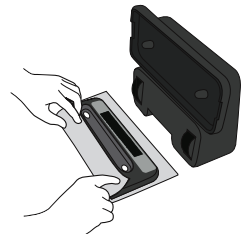

TIP: Fluid dispenses at different rates depending on floor type and solution used. The first time you mop, start with the cloth only slightly damp and then increase the starting cloth wetness if needed.

⚠ NOTICE: To avoid the Pro-Clean Reservoir Pad leaving excess fluid on your floor, do not leave Braava unattended when mopping and remove from floor once Braava stops cleaning.

When mopping is finished:

- Empty any remaining fluid from the reservoir.
- Leave the fill cap open to allow reservoir to dry completely. Do not store the pad on Braava if wet.
- See page 22 for care instructions.

Place the NorthStar® Cube

1. Press the button on the back corner of the NorthStar Navigation Cube to turn it on. *A blue light will flash on the opposite corner when turned on, and then go solid when Braava locks onto it.*

If you forget to turn the Cube on, Braava will send a signal to try to turn it on. *If Braava is successful, the blue flashing light will appear on the Cube.*

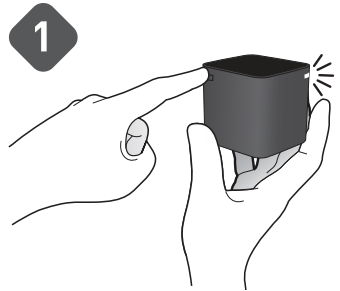

2. Place the NorthStar Navigation Cube on a table or counter top, pointing the blue light away from walls and toward the middle of the room.

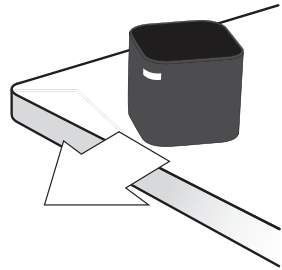

For Best Results

- Place the NorthStar Navigation Cube where it has a clear view of the ceiling (for example, no cabinet or shelf directly above it).
- Do not move the NorthStar Navigation Cube once Braava has started cleaning as it may impair Braava's cleaning performance.
- Do not put the NorthStar Navigation Cube on the floor as the cleaner may run into it and move it.

Start Cleaning

Place Braava on the floor within 6-8 feet of the NorthStar Navigation Cube, facing toward the Cube.

1. Turn Braava on using the power button.
The button will light up blue when the cleaner is on.
2. To start cleaning with a DRY CLOTH just press the Sweep button.
3. To start cleaning with a WET CLOTH just press the Mop button.

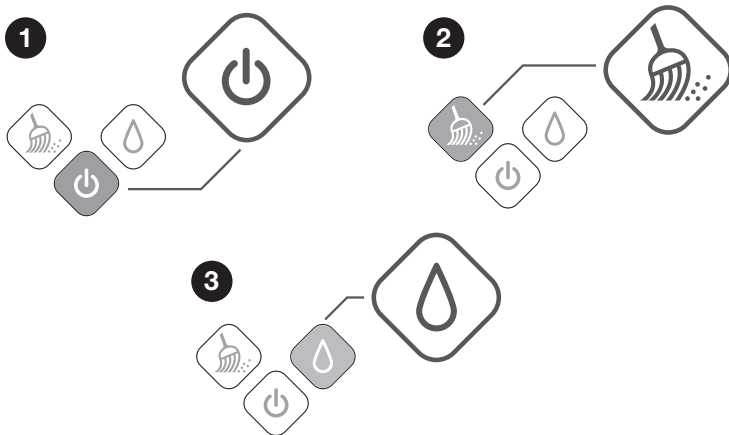

- One blue light will start blinking on the Navigation System Indicator if Braava detects a signal from the Cube. The light will turn solid blue once it locks onto the Cube. *If no lights appear, Braava does not detect a NorthStar signal.*
- When Braava finishes cleaning, it plays a short song, returns to where it started and parks itself. Braava will also do this if the battery runs low while cleaning.
- To turn Braava off, press the power button for two seconds. A tune will play and the light will turn off.
- To turn off the NorthStar Navigation Cube, press the button on the back corner. The light on the opposite corner will turn off.

Maintenance

To keep your Braava in the best working condition, follow these maintenance steps.

Cleaning and Storing

- Use a dry cloth to wipe dust or dirt from Braava's exterior. Do not rinse or submerge in water.
- Use a damp cloth to wipe off dust and dirt on tires. Make sure that Braava is not plugged in and that the cloth is not dripping.
- Place Braava on its end (handle side down) when charging or storing between uses.
- For long term storage remove C batteries from the NorthStar Cube.

Wheel Guard

- As Braava cleans, debris may accumulate around the Wheel Guards. This helps keep Braava's wheels moving freely.
- Periodically check Braava's wheels to see if debris has accumulated and remove as needed.
- A small notch next to the wheel allows access with tweezers or scissors if needed to free the debris.

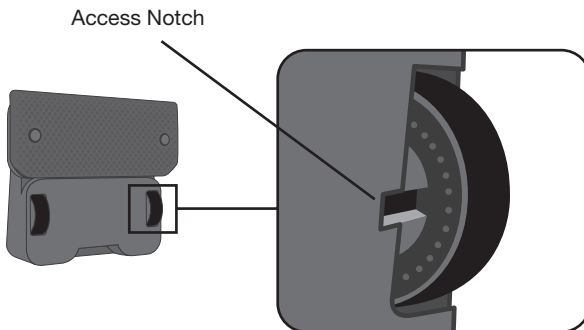

Pro-Clean Reservoir Pad (Sold separately for Braava 320)

- Hand rinse with water in the sink to clean. Do not put the reservoir pad in the dishwasher. Do not wash with soap.
- Let dry completely before re-attaching to Braava after cleaning is complete.
- The wick is designed for repeated use and includes antimicrobial material. Do not remove the wick cap between cleanings.
- If the wick cap becomes dirty or shows wear, it can be replaced.
 - Remove the wick cap by pulling on the side rubber tab.
 - Replace with a new wick cap, pressing firmly into place to create a tight seal to prevent leaking.

Trouble Shooting

Visit global.irobot.com for additional tips and trouble shooting.



Navigation System Indicators (NSI)

Error Indicators on the Navigation System Indicator (NSI) while cleaning

Problem:	Likely Cause	What To Do
Solid red light on the middle NSI.	System error	<ul style="list-style-type: none"> • Press and hold the power button to turn Braava off. • Vigorously rotate both wheels for 15 seconds. • Place Braava on floor and power it on. Make sure a dry cleaning cloth has been applied. • If red light is gone, press Sweep. • If red light persists, contact Customer Support.
Red light blinks 2 to 6 times on the middle NSI.	Braava is stuck in its environment and cannot free itself.	Remove Braava from the situation and restart in a new area.
Red light blinks 14 times on the middle NSI.	Braava has detected the motor is getting too hot.	Turn Braava off and let it cool down before resuming cleaning.
Red light blinks 15 times on the middle NSI.	Braava is stuck in too small of an area and cannot free itself.	Remove Braava from the situation and restart in a new area.
Red light on the middle NSI when pressing Sweep or Mop, accompanied by 3 beeps.	A sensor is activated so Braava won't start driving.	Remove and reapply cleaning cloth. When reapplying, follow these instructions: <ul style="list-style-type: none"> • Ensure cloth does not overlap into the middle channel of the removable cleaning pad • Ensure cloth is not bunching up, which can prevent the removable pad from reattaching completely to the robot.

Error Indicators on the Navigation System Indicator (NSI) while charging

Problem:	Likely Cause	What To Do
Solid red light on the middle NSI.	System error	This is not a charging error, but will prevent Braava from charging while Braava is plugged in. See ' <i>Error Indicators While Cleaning</i> ' chart for instructions.
Red light blinks 7 or 8 times on the middle NSI.	Charging error	Contact Customer Support.
All lights flashing on NSI and buttons and robot beeping while charging.	Incompatible adapter used	Remove the incompatible adapter and use only the adapter included with Braava.

NorthStar® Navigation Cube Troubleshooting

Problem:	Likely Cause	What To Do
Braava is not connecting to the Cube.	Cube and robot position	<p>Turn on the Cube and place it on a raised surface. Point the blue light toward an open area of the room.</p> <p>Place Braava on the floor 6 to 8 feet away from the Cube, facing toward the Cube. Turn Braava on.</p> <p>With a dry cloth on Braava, press the Sweep button. Braava should drive toward the Cube and connect with the Cube within 30 seconds.</p> <p>If the blue Navigation Indicator lights turn solid blue on Braava, it has connected to the Cube. It is ok if the Cube continues flashing.</p> <p>If Braava is not able to drive straight, see “<i>Not Driving Properly</i>” in the General Troubleshooting chart</p>
Cube won't turn on.	C Batteries are dead or inserted incorrectly	Replace with new C batteries and confirm batteries are facing the correct direction.
Cube light is red.	C Batteries are dead	Replace with new C batteries.
Cube turns off while Braava is cleaning.	Signal interference	Make sure Cube is not placed within 5 feet of a Plasma or LCD television and that the Cube is not in a room with fluorescent lighting turned on.
	Braava is out of range	When Braava travels out of range, it is normal for the Cube to turn off. When Braava returns it will send a message to the Cube to turn it back on.
Multiple Cubes are set up, but Braava is only using one Cube.	Cube position	<p>Braava must be able to encounter a second Cube while cleaning to use it. Make sure the second Cube is not isolated in an area where Braava cannot get to it.</p> <p>Try placing Cubes with just 15 feet between them to help Braava connect, then move the Cubes farther apart for subsequent cleaning cycles. Do not move the Cubes while Braava is cleaning.</p>
Multiple Cubes are set up, but Braava is over-cleaning many areas.	Cube channels	Confirm the Cubes in use all have different channels. The channel number can be found on the bottom of each Cube.

Pro-Clean Reservoir Pad Troubleshooting

Problem:	Likely Cause	What To Do
Leaking or leaving puddles.	Loose wick or fill cap	Check the fill cap and the wick cap and make sure both are securely sealed shut. Fluid will dispense at a faster rate if these caps are not sealed.
Not wicking fluid.	Wick cap requires replacement	Refer to Reservoir Pad maintenance for instructions to replace the wick cap.

General Troubleshooting

Problem:	Likely Cause	What To Do
Braava Cleans only a small area.	Cube not being used	Make sure the Cube is turned on and placed in the area you want to clean. Check the position of the Cube for interference such as: <ul style="list-style-type: none">• Cabinets, shelves or ceiling fans above the Cube.• Very high, uneven or black ceilings above the Cube.• Plasma or LCD televisions within 5 feet of Cube.
	Cleaning cloth application	Remove and reapply cleaning cloth. When reapplying, follow these instructions: <ul style="list-style-type: none">• Ensure cloth does not overlap into the middle channel of the removable cleaning pad• Ensure cloth is not bunching up, which can prevent the removable pad from reattaching completely to the robot.
	Problem with wheels or treads	Check wheel area for debris and remove or clean as needed. Examine tire treads to make sure they are securely attached to the wheel. If not well attached, contact Customer Support.
Braava is not driving properly.	Wheels slipping	Clean wheels with a cloth dampened with warm water to remove dust and cleaning solution. Let the wheels dry before cleaning again.
	Cleaning cloth application	Remove and reapply cleaning cloth. When reapplying, follow these instructions: <ul style="list-style-type: none">• Ensure cloth does not overlap into the middle channel of the removable cleaning pad• Ensure cloth is not bunching up, which can prevent the removable pad from reattaching completely to the robot.
	Problem with wheels or treads	<ul style="list-style-type: none">• Check wheel area for debris and remove or clean as needed.• Examine tire treads to make sure they are securely attached to the wheel. If not well attached, contact Customer Support.

Problem:	Likely Cause	What To Do
Braava is backing up.	Floor transition sensor is activated	Remove and reapply cleaning cloth. When reapplying, follow these instructions: <ul style="list-style-type: none"> • Ensure cloth does not overlap into the middle channel of the removable cleaning pad • Ensure cloth is not bunching up, which can prevent the removable pad from reattaching completely to the robot. If flooring is uneven or has wide grout lines, place Braava on smoother flooring to see if problem persists.
Braava drives off and does not clean where I started it.	Braava is in Pause/Resume mode	Braava may still be in pause/resume mode from a previous cleaning run. Tap the power button to exit pause/resume mode.
When resuming after pausing, Braava cleans the same area.	Robot position when resuming	It is normal for Braava to re-clean an area while trying to find its position. <ul style="list-style-type: none"> • To help Braava find its position quickly, restart Braava near the Cube in the same orientation and location as the beginning of the cleaning cycle. • If Braava does not successfully find its position it will start a new cleaning cycle.
Braava won't hold a charge.	Incorrect adapter or battery	Confirm the adapter has the same model number as noted on the bottom of your Braava and use only an official Braava battery. If problem persists, contact Customer Support.
	Battery needs refresh charge	Charge Braava for 12 hours using the adapter and not a Cradle, then run Braava until battery fully depletes. Repeat 3 times to achieve expected run times.

Get Robot Updates

Register your Robot! Go to global.irobot.com

iRobot Customer Care USA & Canada

If you have questions or comments about this product please contact iRobot before contacting a retailer.

Please visit the iRobot home support site at www.irobot.com/support for support tips, frequently asked questions, or information about accessories and other iRobot products.

Should you still need assistance:

Call our Customer Care team at **877.855.8593**.

iRobot Customer Care Hours:

- Monday – Friday 9AM – 7PM Eastern Time
- Saturday 9AM – 6PM Eastern Time

iRobot Customer Care Outside USA & Canada

Visit global.irobot.com to:

- Learn hints and tips to improve the performance of your robot
- Get answers to questions
- Download a detailed product manual
- Contact your local distributor



© 2008-2013 iRobot Corporation, 8 Crosby Drive, Bedford, MA 01730 USA | All rights reserved.
iRobot and NorthStar are registered trademarks of iRobot Corporation. Braava is a trademark of iRobot Corporation.
Swiffer and WetJet are registered trademarks of Procter and Gamble.
Target is a registered trademark of Target Brands Inc.

U.S. Pat. <http://www.irobot.com/patent> | Other Patents Pending. WC:4407714.Braava300Series.Manual_EN