

# ***Shark*** ION ROBOT™

**RV700**

**Series**

---

## **INSTRUCTIONS**



 [sharkclean.com](http://sharkclean.com)

 1-800-798-7398

# THANK YOU



for purchasing the Shark ION ROBOT™

---



 **TIP:** You can find the model and serial numbers on the QR code label located near the rating label on the underside of the unit.

## REGISTER YOUR PURCHASE

-  [registeryourshark.com](http://registeryourshark.com)
-  1-800-798-7398
-  Scan QR code using mobile device

## RECORD THIS INFORMATION

Model Number: \_\_\_\_\_

Serial Number: \_\_\_\_\_

Date of Purchase (Keep receipt): \_\_\_\_\_

Store of Purchase: \_\_\_\_\_

## TECHNICAL SPECIFICATIONS

Voltage: 14.8 V

Battery type: DC 14.8 V Li-ion 2600 mAh

Expected cleaning time: 60-minute

Expected charging time: 3 hours

## PLEASE READ CAREFULLY AND KEEP FOR FUTURE REFERENCE.

This instruction manual is designed to help you get a complete understanding of your new Shark ION ROBOT.

If you have any questions, please call the Customer Service line at 1-800-798-7398.

# CONTENTS

---

<b>Important Safety Instructions .....</b>	<b>3</b>
<b>Getting To Know Your Shark ION ROBOT™ .....</b>	<b>7</b>
<b>Charging Your Shark ION ROBOT.....</b>	<b>9</b>
Installing the Charging Dock .....	9
Important Charging Information .....	9
Battery Charge Indicator Lights .....	10
Installing the Side Brushes .....	11
<b>Using Your Shark ION ROBOT .....</b>	<b>12</b>
Using the Remote Control (Select Models) .....	12
Setting the Day of the Week and Time on the Remote Control.....	12
Setting Your Cleaning Schedule on the Remote .....	13
BotBoundary™ Strips .....	15
Cleaning Modes .....	16
Sending Shark ION ROBOT to Charging Dock .....	16
<b>Maintaining Your Shark ION ROBOT .....</b>	<b>17</b>
Emptying the Dust Bin .....	17
Cleaning the Filters .....	18
Cleaning the Brushroll .....	19
Cleaning the Cliff Sensors and Charging Pads.....	20
Cleaning the Side Brushes.....	20
Replacing the Side Brushes.....	20
Cleaning the Removable Front Wheel.....	21
Replacing the Battery .....	22
Tips and Tricks .....	23
BotBoundary Strips .....	24
<b>Troubleshooting Guide .....</b>	<b>25</b>
<b>Warranty.....</b>	<b>26</b>

# IMPORTANT SAFETY INSTRUCTIONS

PLEASE READ CAREFULLY BEFORE USE • FOR HOUSEHOLD USE ONLY

---

## **⚠ WARNING**

**To reduce the risk of injury, fire, electric shock, and property damage resulting from improper use of the appliance, carefully observe the following instructions. This unit contains electrical connections and moving parts that potentially present risk to the user.**

**When using an electrical appliance, basic precautions should always be followed, including the following:**

- 1** Inspect battery, charging dock, and charger before use. **DO NOT** use battery, dock, or charger if damaged or modified. Damaged or modified batteries may exhibit unpredictable behavior, resulting in fire, explosion, or risk of injury.
- 2 DO NOT** use outdoors or on wet surfaces.
- 3** If vacuum cleaner is not working as it should, or has been dropped, damaged, left outdoors, or immersed in water, return it to SharkNinja Operating LLC for examination, repair, or adjustment.
- 4 DO NOT** handle charger, charging dock, or Shark ION ROBOT™ with wet hands.
- 5** Keep charging dock away from heated surfaces. **DO NOT** expose unit or battery to fire or excessive temperature. Exposure to fire or temperature above 265°F (130°C) may cause explosion.
- 6** Use only Shark® chargers and batteries for your robot. Other types of batteries may burst, causing injury and damage.

## **GENERAL USE**

- 7** Use only as described in this manual.
- 8** Keep your work area well lit.
- 9 DO NOT** place vacuum cleaner on unstable surfaces such as chairs or tables.
- 10 DO NOT** put any objects into openings. **DO NOT** use with any opening blocked; keep free of dust, lint, hair, and anything that may reduce airflow.
- 11 DO NOT** allow young children to operate the appliance or use as a toy. **DO NOT** operate the vacuum in a room where an infant or child is sleeping. Close supervision is necessary when using near children or pets.
- 12 DO NOT** use without brushroll, dust bin, and all filters in place.
- 13 DO NOT** stand or sit on the Shark ION ROBOT.
- 14** Store unit indoors. **DO NOT** use or store unit below 37.4°F (3°C). Ensure unit is at room temperature before operating.
- 15** Clean unit with a damp cloth, using only water.
- 16** Keep hair, loose clothing, fingers, and all parts of body away from all openings and moving parts.

# SAVE THESE INSTRUCTIONS

---

- 17** Before using vacuum cleaner, pick up objects like clothes, paper, and cords for blinds or curtains. Move power cords and fragile objects out of the way. **DO NOT** operate unit in areas where there are lit candles or fragile objects on the floor or on furniture that the unit may accidentally bump into.
- 18** Unit should not be used near balconies or stairs. Use a physical barrier or BotBoundary™ strip to prevent unit from accessing balconies and stairs.
- 19 DO NOT** place anything on top of the unit.
- 20** Take care when walking in work areas to avoid stepping on or tripping over the unit as it moves on its own.
- 21 DO NOT** operate unit on floors with exposed electrical outlets.
- 22** There are no user-serviceable parts. **DO NOT** attempt to service the electronics of this unit, the battery, or the dock.
- 23** Use only on hard-floor surfaces or low-pile carpet. **DO NOT** use on unsealed or unfinished floors.
- 24** To prevent unintentional starting, ensure the main power switch is in the OFF position before connecting to charger or dock, and before picking up or carrying the unit. **DO NOT** carry unit with your finger on the power switch.

## FILTERS

- 25** Make sure that all filters are thoroughly dry after routine cleaning.
- 26** Use only Shark®-brand filters and accessories. Using other brands will void warranty.

## GENERAL CLEANING

- 27 DO NOT** vacuum up hard or sharp objects such as glass, nails, screws, or coins that could damage the vacuum cleaner.
- 28 DO NOT** vacuum up drywall dust, fireplace ash, or embers.
- 29 DO NOT** vacuum up smoking or burning objects such as hot coals, cigarette butts, or matches.
- 30 DO NOT** vacuum up flammable or combustible materials (e.g., lighter fluid, gasoline, or kerosene) or use vacuum in areas where they may be present.
- 31 DO NOT** vacuum up toxic solutions (e.g., chlorine bleach, ammonia, or drain cleaner).
- 32 DO NOT** use in an enclosed space where vapors are present from paint, paint thinner, moth-proofing substances, flammable dust, or other explosive or toxic materials.
- 33 DO NOT** vacuum up any liquids.
- 34 DO NOT** immerse vacuum cleaner in water or other liquids.

# IMPORTANT SAFETY INSTRUCTIONS

PLEASE READ CAREFULLY BEFORE USE • FOR HOUSEHOLD USE ONLY

---

## **⚠ WARNING**

To reduce the risk of injury, fire, electric shock, and property damage resulting from improper use of the appliance, carefully observe the following instructions. This unit contains electrical connections and moving parts that potentially present risk to the user.

### **BATTERY AND CHARGING**

- 35** Recharge only with the charging dock and charger specified by the manufacturer. A charger that is suitable for one type of battery may create a risk of fire when used with another battery.
- 36 DO NOT** charge at temperatures below 50°F (10°C) or above 104°F (40°C). Charging improperly or at temperatures outside of the specified range may damage the unit and increase the risk of fire.
- 37** Under abusive conditions, liquid may be ejected from the battery; avoid contact. If contact accidentally occurs, flush with water. If liquid contacts eyes, seek medical help. Liquid ejected from the battery may cause irritation or burns.
- 38** Appliance should be serviced only by a qualified repair person using only identical replacement parts. **DO NOT** modify or attempt to repair Shark ION ROBOT™ or charging dock yourself, except as indicated in the instructions for use and care.
- 39** Before disposing of the Shark ION ROBOT, the battery must be removed. To remove, unscrew the battery cover with a Phillips-head screwdriver, then detach the battery from the connector.
- 40** Used batteries must be disposed of or recycled in accordance with local ordinances or regulations. Note that in some areas, it is illegal to place spent lithium-ion batteries in the trash or in a municipal solid waste stream.

## CONFORMITY INFORMATION

This equipment has been tested and found to comply with the limits for a Class B digital device, pursuant to part 15 of the FCC Rules. These limits are designed to provide reasonable protection against harmful interference in a residential installation. This equipment generates, uses, and can radiate radio frequency energy, and if not installed and used in accordance with the instructions, may cause harmful interference to radio communications. However, there is no guarantee that interference will not occur in a particular installation. If this equipment does cause harmful interference to radio or television reception (which can be determined by turning the equipment off and on) the user is encouraged to try to correct the interference by one or more of the following measures:

- Reorient or relocate the receiving antenna.
- Increase the distance between the equipment and receiver.
- Connect the equipment into an outlet on a circuit different from that to which the receiver is connected.
- Consult the dealer or an experienced radio/TV technician for help.

Changes or modifications not expressly approved by the party responsible for compliance could void the user's authority to operate the equipment.

# GETTING TO KNOW YOUR SHARK ION ROBOT™

## WELCOME!

Congratulations on your purchase. Use this instruction manual to learn about your new vacuum's great features. From assembly to use to maintenance, you will find it all in here.

**NOTE:** When using for the first time, fully charge and discharge your Shark ION ROBOT to condition the battery. Failure to do so may cause LED indications to work incorrectly.

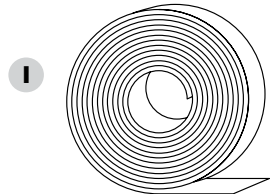
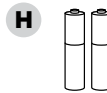
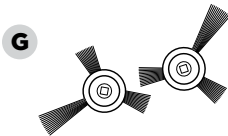
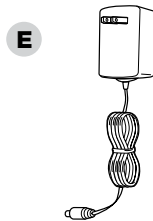
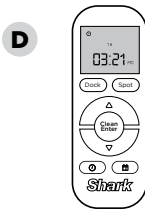
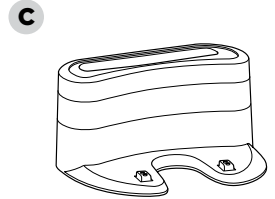
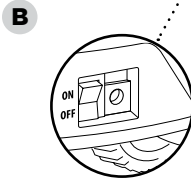
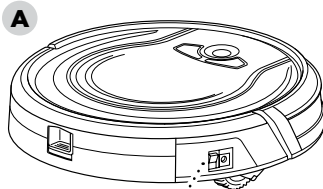

- A** Shark ION ROBOT
- B** Main Power Switch
- C** Charging Dock
- D** Remote Control (select models)
- E** Charger

- F** Hair Removal Tool
- G** Side Brush (x2)
- H** AAA Batteries (x2)
- I** BotBoundary™ Strip
- J** BotBoundary Connectors (x2)



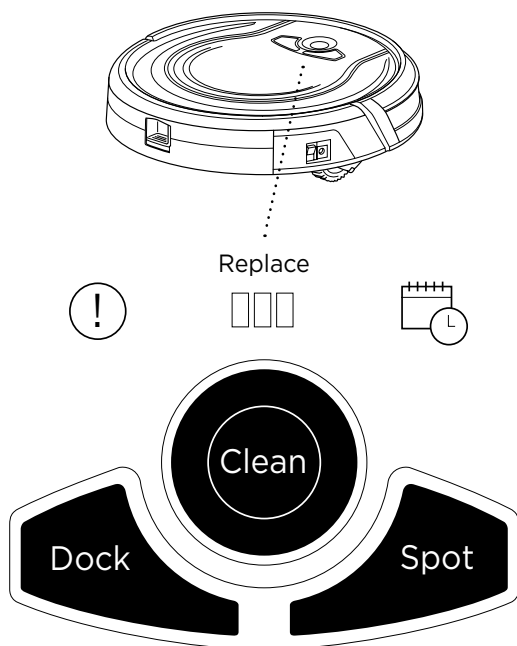

### **CLEAN BUTTON**

To begin cleaning with your Shark ION ROBOT™, press the **CLEAN** button. Press button again to stop.

### **DOCK BUTTON**

Press **DOCK** button to stop cleaning and send the unit back to the charging dock.

### **SPOT BUTTON**

For thorough cleaning of an area of concentrated dust or debris, press the **SPOT** button.

### **“!” ERROR INDICATOR**

When a blockage or a filter problem occurs, the “!” error indicator light will illuminate. Clear any blockages and clean filters. Remove dust bin and make sure nothing is blocking suction. See page 23 for a full list of error codes.

### **BATTERY CHARGE INDICATOR LIGHTS**

The indicator lights display the amount of charge remaining in the battery. See page 10 for more details.

### **SCHEDULE INDICATOR**

Illuminates when a cleaning time is actively scheduled.

# CHARGING YOUR SHARK ION ROBOT™

★ **IMPORTANT:** Install the charging dock in a location that can be easily accessed by your Shark ION ROBOT.

Always keep the charging dock plugged in, or the Shark ION ROBOT will not be able to automatically return to the base.

The Shark ION ROBOT will beep when it is first connected to power or when it starts charging on the dock.

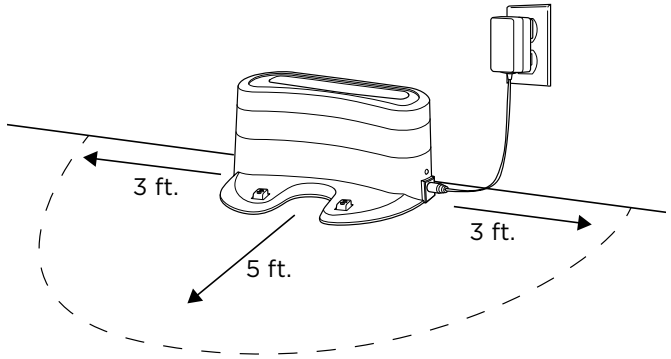

## RECYCLING YOUR BATTERY

When your robot's battery needs to be replaced, dispose of it or recycle it in accordance with local ordinances or regulations. In some areas, it is illegal to place spent lithium-ion batteries in the trash or in a municipal solid waste stream. Return spent batteries to an authorized recycling center or to retailer for recycling. Contact your local recycling center for information on where to drop off the spent battery.

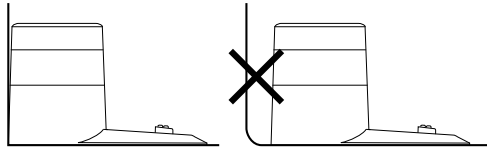

## INSTALLING THE CHARGING DOCK

Set the charging dock on a hard, level surface, with its back against the wall. Remove any objects that are closer than 3 feet (1 meter) from either side of the base, or closer than 5 feet (1.52 meters) from the front of the base. Plug the charging cable into the port on the side of the dock, and connect the charger plug to a wall outlet.

## IMPORTANT CHARGING INFORMATION

The Shark ION ROBOT has a pre-installed rechargeable battery. Battery must be fully charged before using. The Power switch must be in the ON position in order to charge the battery.

When the cleaning cycle is complete or the battery is running low, Shark ION ROBOT will automatically return to the charging dock.

If your unit doesn't return to the dock, the battery charge may have run out. See charging instructions on page 10.

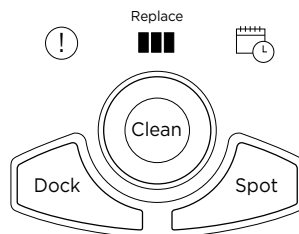
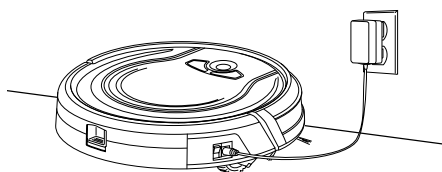
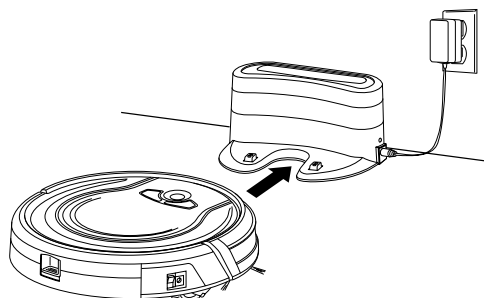
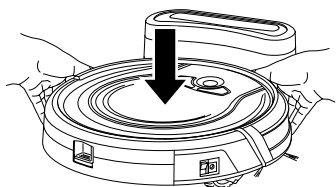

## BATTERY CHARGE INDICATOR LIGHTS

While the battery is charging, all three blue LED lights will cycle until fully charged.

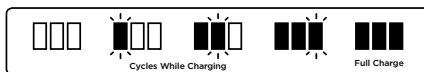

As the unit cleans, its battery discharges. The blue lights indicate how much charge is remaining.



### Shark ION ROBOT™ can be charged three different ways:

- 1 Manually place Shark ION ROBOT on the charging dock, aligning its charging pads with the charging contacts on the base.
- 2 Press the **DOCK** button on the remote or robot to automatically send Shark ION ROBOT to the charging dock.
- 3 To charge unit directly, plug the charger into a wall outlet, then connect the charger cable to the jack on the side of the Shark ION ROBOT.

If the red “Replace” light is on, then the battery needs to be replaced. See page 22 for more information. If all the battery indicator lights are off, then either the power switch is turned off or there is no charge remaining. Turn the Power switch to the ON position. If all indicator lights remain off, then charge the unit directly, using the charger.

# SETTING UP YOUR SHARK ION ROBOT™

★ **NOTE:** Some carpets may cause the robot to malfunction due to pile height.

★ **IMPORTANT:** Before cleaning an entire room for the first time, we recommend that you first test your unit on a small section of the floor to ensure there is no scratching.

★ **IMPORTANT:** Shark ION ROBOT uses cliff sensors to avoid stairs and other steep drops. Sensors may work less effectively when they are dirty. For best results, clean sensors as needed.

💡 **TIP:** Turn off the power switch if Shark ION ROBOT will not be used for a long period of time.

💡 **TIP:** To preserve battery life, unit should be recharged at least once every three months.

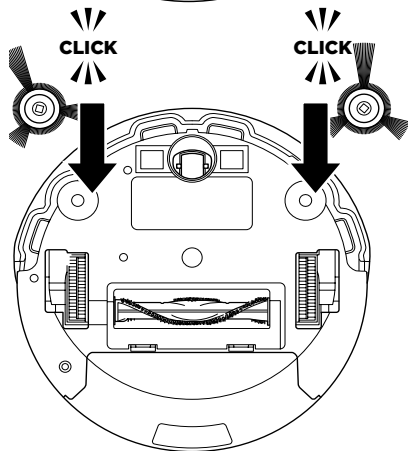
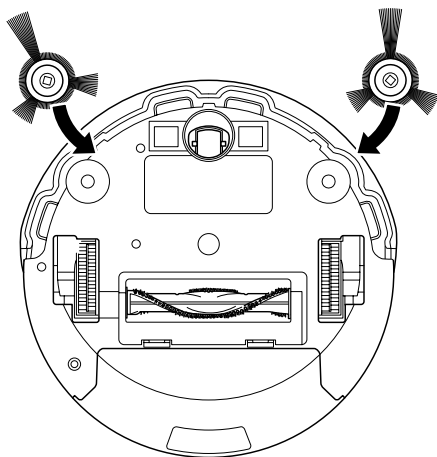

## INSTALLING THE SIDE BRUSHES

- 1 Turn the unit over.
- 2 Align hole in center of side brush over brush post on bottom of unit.
- 3 Press side brush down over the post until it snaps into place.

# USING YOUR SHARK ION ROBOT™

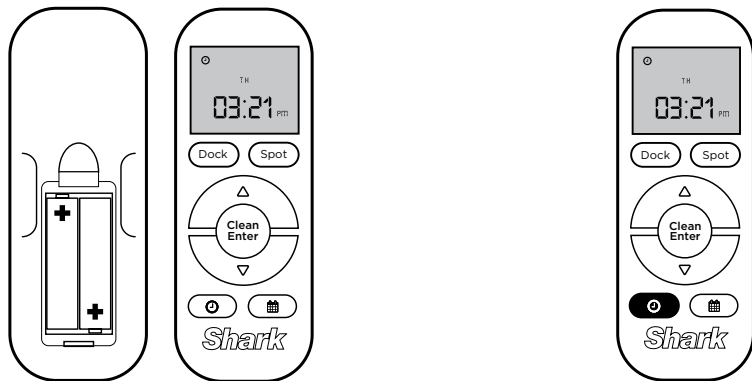

## USING THE REMOTE CONTROL (SELECT MODELS)

The remote control requires 2 AAA batteries. Install batteries into remote before using.

With the remote control, you can start and stop Shark ION ROBOT, select Spot Cleaning mode, send the unit back to the charging dock, and program a cleaning schedule for your robot.

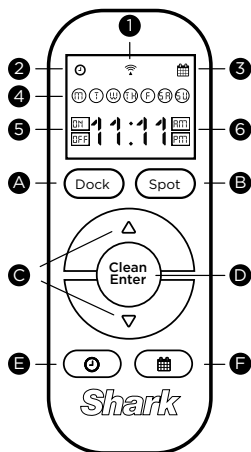

- |                              |                        |
|------------------------------|------------------------|
| 1 Signaling Icon             | A Dock Button          |
| 2 Time Icon                  | B Spot Clean Button    |
| 3 Schedule Icon              | C Up/Down Arrows       |
| 4 Days Of The Week (Mon-Sun) | D Confirm/Clean Button |
| 5 Scheduling (On/Off)        | E Time Button          |
| 6 Time                       | F Schedule Button      |

## SETTING THE DAY OF THE WEEK AND TIME ON THE REMOTE CONTROL

- 1 Press and hold the **TIME** button (with the clock icon) on the remote for one second. On the screen, the day of the week display will begin flashing.
- 2 Press the **UP/DOWN** arrows on the remote control to select the day of the week, then press the **CLEAN/ENTER** button (the center button with the arrow) to set. On the screen, the hour field in the time display will begin flashing.
- 3 Use the **UP/DOWN** arrows on the remote control to select the hours, then press the **CLEAN/ENTER** button to set. On the screen, the minutes field in the time display will begin flashing.
- 4 Use the **UP/DOWN** arrows to select the minutes, then press the **CLEAN/ENTER** button to set. On the screen, AM and PM will begin to flash.
- 5 Use the **UP/DOWN** arrows to select AM or PM, then press the **CLEAN/ENTER** button to set.
- 6 Once you have finished setting the time, you can proceed to setting a cleaning schedule.

# USING YOUR SHARK ION ROBOT™ - continued

 **TIP:** Whenever you use the remote control, make sure you point it directly at Shark ION ROBOT, and ensure that Shark ION ROBOT is powered on.

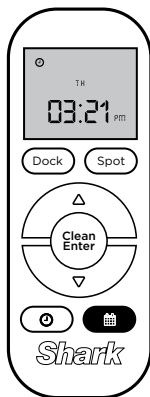

## SETTING YOUR CLEANING SCHEDULE ON THE REMOTE

- 1** To schedule a cleaning, the day and time must be set. If you haven't yet set the date and time, follow the steps on page 12.
- 2** To schedule or edit a cleaning, press and hold the **SCHEDULE** button (with the calendar icon) on the remote control for one second. On the screen, the day of the week display will flash.
- 3** Use the **UP/DOWN** arrows on the remote to select the day of the week for your scheduled cleaning. (Days with a cleaning already scheduled will be circled. If a day is not circled, there is no cleaning scheduled for that day yet.) Press the **CLEAN/ENTER** button on the remote to set the day. The day of the week will remain flashing until the cleaning time is completely scheduled.
- 4** Use the **UP/DOWN** arrows on the remote to turn ON or OFF the cleaning scheduled for the selected day. Press **CONFIRM/CLEAN** to confirm selection.
- 5** If OFF is selected, the screen will display the days of the week again, with no time or AM/PM options. If ON is selected, a circle will appear around the selected day. To change the time of the cleaning on the selected day, use the **UP/DOWN** arrows on the remote to select the hour of the cleaning, then press **CLEAN/ENTER** to set.
- 6** On the screen, the minutes field in the time display will begin flashing. Use the **UP/DOWN** arrows to select the minutes, then press the **CLEAN/ENTER** button to set. On the screen, AM and PM will begin to flash.

- 
- 7** Use the **UP/DOWN** arrows to select AM or PM, then press the **CLEAN/ENTER** button to set. Use the **UP/DOWN** arrows on the remote to select another day for a scheduled cleaning.
  - 8** When all days and times for scheduled cleanings are set, press the **SCHEDULE** button on the remote to exit. (After 30 seconds of inactivity, the system will time out.)
  - 9 Important:** Once all scheduling is complete, the data must be sent to the Shark ION ROBOT™. To send the scheduling data, press and hold the Up arrow on the remote for two full seconds. The Signal icon will appear onscreen.

## VIEWING SCHEDULED CLEANINGS

- 1** To view previously scheduled cleanings, press the **SCHEDULE** button on the remote.
- 2** Once the **SCHEDULE** button has been selected, the screen will display the days of the week. Circles will appear around the days with scheduled cleanings. (This action will time out within 15 seconds of selecting the **SCHEDULE** button on the remote.)

# USING YOUR SHARK ION ROBOT™ - continued

**NOTE:** Before cleaning, the robot's power must be turned on. Press the top of the power switch on the side of the unit to turn on power.

 **TIP:** Shark ION ROBOT will automatically return to the charging dock when the battery level is low.

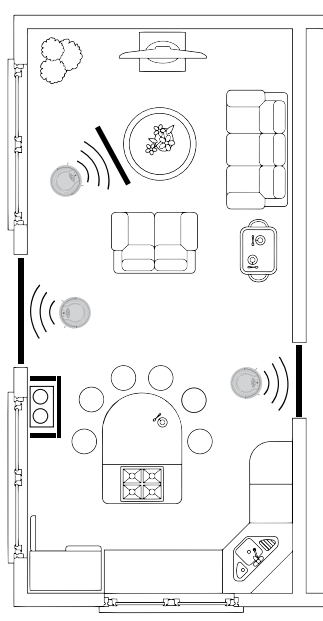

## BOTBOUNDARY™ STRIPS

You may need to keep Shark ION ROBOT away from certain areas, such as pet bowls, fragile objects, power strips, or doorways. Use the BotBoundary strips to quickly and easily create “no-go zones” to keep Shark ION ROBOT out of the areas you would like it to avoid.

- 1 Identify areas or objects you want Shark ION ROBOT to avoid. Cut the BotBoundary strip to the desired length so that it covers the entire perimeter of an object or spans the length of the doorway you want to block off.

With the provided connecting joints, you can shape the strips to fit your needs. Insert the ends of the strips into the connecting joints to form angles and create customized boundaries. You can connect up to four BotBoundary strips at a time.

- 2 Place the strips on the floor or under an area rug to create perimeters around the objects and areas you'd like to block.

**NOTE:** If blocking an object, place the BotBoundary strip two inches in front to ensure Shark ION ROBOT will not bump into it.



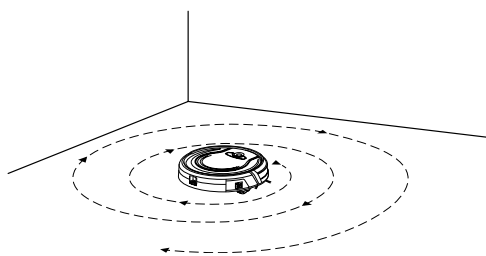
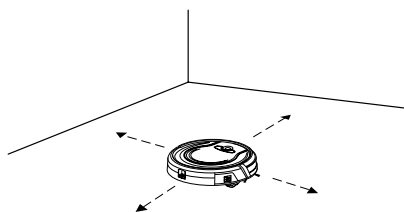
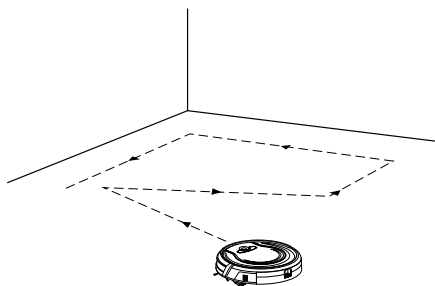

## CLEANING MODES

### Manual Start/Stop

You can manually start and stop Shark ION ROBOT™.

- 1** To start cleaning, press the **CLEAN** button on Shark ION ROBOT or the **CLEAN/ENTER** button on the remote control. Shark ION ROBOT selects different cleaning modes and automatically operates until cleaning is complete.
- 2** To stop the unit before it automatically finishes cleaning and returns to dock, press the **CLEAN** button on Shark ION ROBOT or the **CLEAN/ENTER** button on the remote control.

### Spot Cleaning

In Spot mode, Shark ION ROBOT will thoroughly clean an area in a spiral pattern. Use Spot mode to clean a concentrated area of dust or debris.

- 1** To start cleaning in Spot mode, press the **SPOT** button on Shark ION ROBOT or on the remote control.

### SENDING SHARK ION ROBOT TO CHARGING DOCK

To return the unit to the Charging Dock, press the **DOCK** button on the unit or on the remote control.

# MAINTAINING YOUR SHARK ION ROBOT™

**⚠ WARNING:** Wash the dust bin and filter cover with water only. Be sure to air-dry them completely before reassembling. **DO NOT** wash the HEPA filter with water, as it may damage the filter and reduce suction power.

**⚠ CAUTION:** Turn off power before performing any maintenance.

**💡 TIP:** For best results, empty the dust bin after every cleaning.

---

## RECOMMENDED CLEANING SCHEDULE:

### Dust Bin

Empty after each use

### Main Brushroll

Check weekly

### Side Brushes

Check weekly

### Dust Bin Filter

Clean weekly

### Front Caster Wheel

Remove and clean weekly

## RECOMMENDED REPLACEMENT SCHEDULE:

### Main Brushroll

Every 6–12 months

### Side Brushes

When visibly worn

### Dust Bin Filter

Every 2 months

### Front Caster Wheel

Every 12 months

## STEP 1

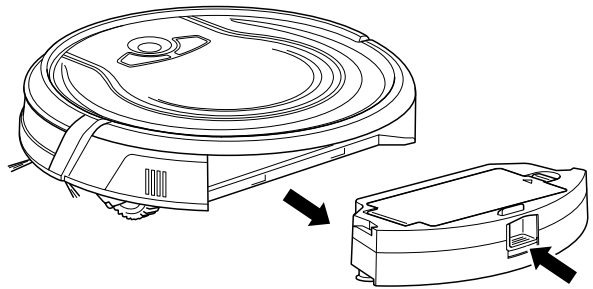

## STEP 2

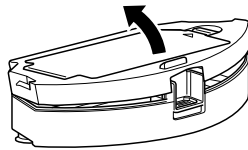

## STEP 3

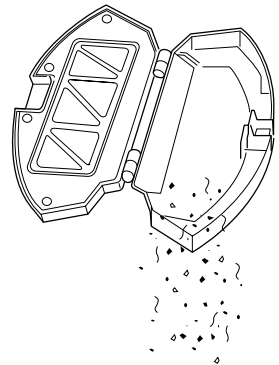

## EMPTYING THE DUST BIN

- 1 Press the dust bin removal latch and slide out the dust bin.
- 2 Open the dust bin.
- 3 Empty debris and dust into trash.

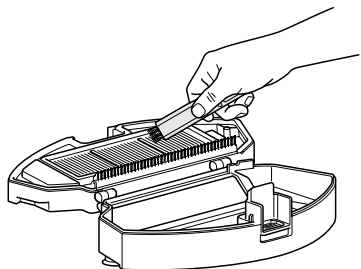
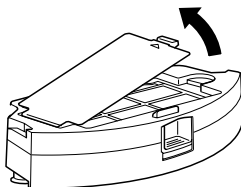
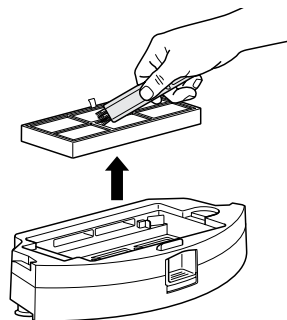
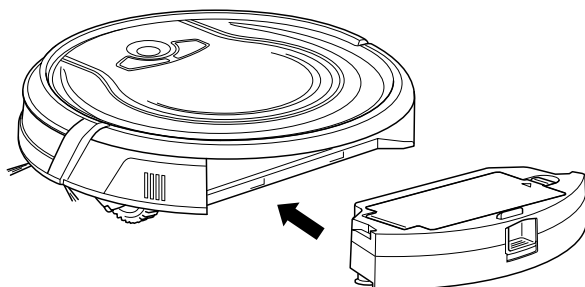
**STEP 1****STEP 2****STEP 3****STEP 4****CLEANING THE FILTERS**

- 1** With the dust bin out of the unit, clear hair from the Anti-Tangle Comb on the dust bin.
- 2** Press the filter door release button to open the door and remove the filters.
- 3** Clean the dust bin and filters with a cleaning brush.
- 4** Replace the filters and the filter cover. Close the dust bin and slide it back into the Shark ION ROBOT™.

# MAINTAINING YOUR SHARK ION ROBOT™ - cont'd.

**⚠ CAUTION:** Turn off power before performing any maintenance.

**★ NOTE:** When cleaning brushroll, be sure to not cut anything other than hair, string, fibers, or other debris.

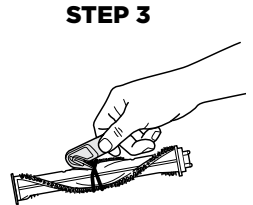
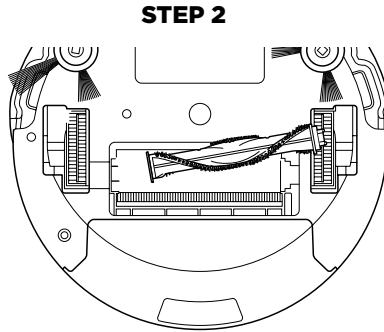
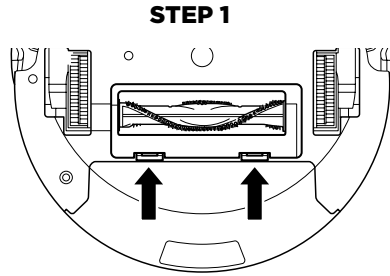

## CLEANING THE BRUSHROLL

- 1** Push up on the tabs on the brushroll access door, then lift off the door.
- 2** Remove the brushroll.
- 3** Clean the brushroll with the provided hair removal tool.
- 4** To reinstall the brushroll, insert the flat end first, then the protruding end, then click brushroll securely into place.
- 5** Close the brushroll access door and press down until it clicks into place.

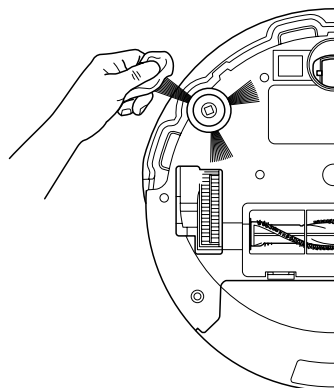
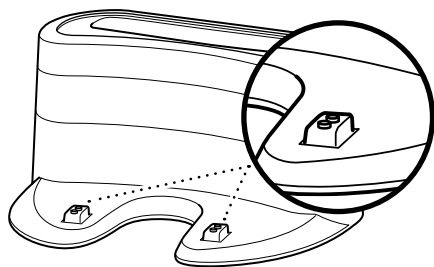
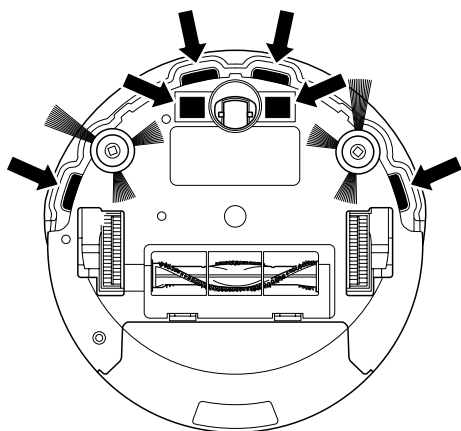

### **CLEANING THE CLIFF SENSORS AND CHARGING PADS**

For best results, clean cliff sensors and charging pads periodically as needed. With a cloth or a cleaning brush, gently dust off the sensors and pads.

### **CLEANING THE SIDE BRUSHES**

The side brushes need regular cleaning, as dirt may adhere to them and hair and fibers can easily get tangled in them.

- 1** Carefully unwind and remove string and hair from side brushes.
- 2** Gently wipe side brushes with a damp cloth. Be sure to let them air-dry completely before replacing them.

### **REPLACING THE SIDE BRUSHES**

To remove a bent or damaged side brush, pull it off its post. To install new side brush, align hole in center of brush over post on bottom of unit. Press side brush down over the post until it clicks into place.

# MAINTAINING YOUR SHARK ION ROBOT™ - cont'd.

**⚠ CAUTION:** Turn off power before performing any maintenance.

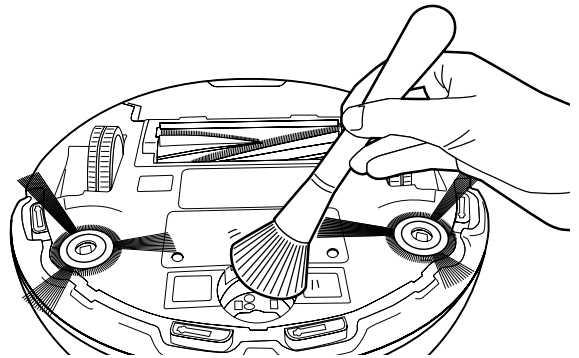
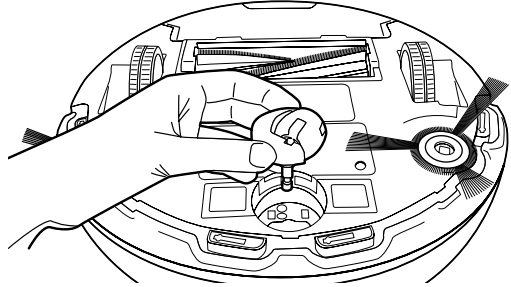

## **CLEANING THE REMOVABLE FRONT WHEEL**

The sensor below the removable rotating front wheel on the bottom of the unit should be cleaned once a week. Pull out the wheel and carefully dust the sensor in the cavity below. Replace the wheel and push it in until it clicks into place.

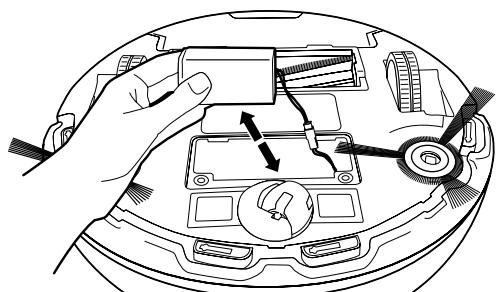
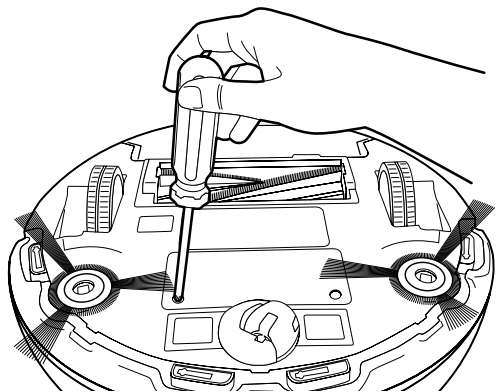

## REPLACING THE BATTERY

When the battery needs replacement, the red “Replace” light will illuminate.

To remove the battery, turn the unit over and unscrew the battery cover with a Phillips-head screwdriver. Unplug the old battery from its connector, then plug in the new battery. Replace battery cover and screw it back into place.

Replacement batteries can be purchased at [sharkaccessories.com](http://sharkaccessories.com)

# TIPS AND TRICKS FOR GREAT PERFORMANCE

Your Shark ION ROBOT™ is designed with **Smart Sensor** technology so it can clean all areas of your floors and navigate its way out of tight spaces. During your first few cleanings, you may need to make some small adjustments to optimize your robot's performance.

## CORDS AND OBSTRUCTIONS

Always prep your home before cleaning. Some furniture or loose cords may create problems for your robot. Clear away cords and obstructions or block off the area with the included BotBoundary™ strips.

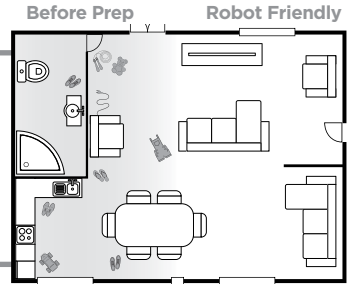

## LOW-CLEARANCE FURNITURE

Your robot may find its way under furniture with low clearance, but not be able to free itself. Use furniture risers to increase clearance, or create a no-go zone with the included BotBoundary strips.

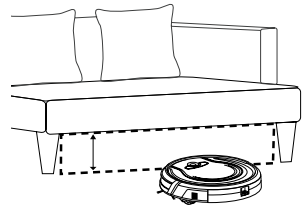

## DOORWAY THRESHOLDS

Your robot can easily climb over most common thresholds. However in some situations they may present a challenge. Use the included BotBoundary strips to block off these areas.

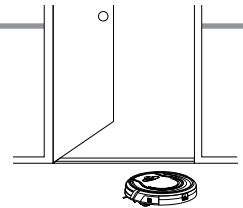

## RETURNING TO DOCK

Make sure the dock is set up as shown. If your robot roams too far, it could have trouble finding the dock. It may be helpful to block off part of your home with the included BotBoundary strips, or to add a second dock (available at [sharkaccessories.com](http://sharkaccessories.com))

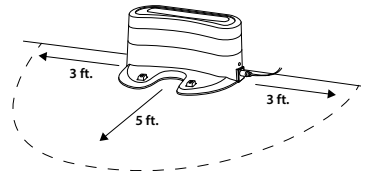

Tip: You can use the included connectors to create angles with your included BotBoundary strips.



# PREPPING YOUR HOME USING BOTBOUNDARY™ STRIPS

Use the BotBoundary strips to quickly and easily create “no-go zones” to keep your robot out of the areas you would like it to avoid. These may include:

- Near power cords that might cause tangles
- Hallways where you'd rather your robot not travel
- Around furniture with low clearance that may trap your robot

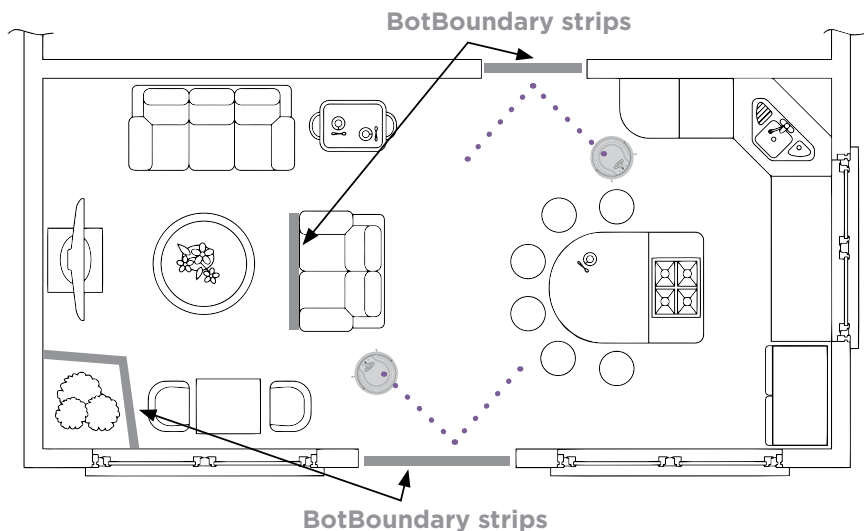
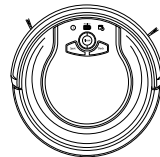

## USAGE INSTRUCTIONS

1. Cut the BotBoundary strip to the desired length, 18" Minimum, so it covers the entire perimeter of an object or spans the length of the doorway you'd rather your robot not cross.
2. Simply lay the BotBoundary strip flat on the floor or under an area rug. For best results, make sure your BotBoundary strip is completely flat against the floor.
3. With the provided connectors, you can create angles to customize the BotBoundary strips to fit your home.

When setting up your BotBoundary strips it is useful to either make a closed loop around an object using the included connectors or to place them between fixed objects, like door frames or legs of a couch.

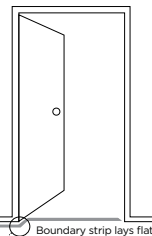
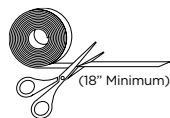

# TROUBLESHOOTING GUIDE

**⚠ WARNING: Always turn off Power switch before performing any maintenance.**

If any error lights are illuminated or flashing on your Shark ION ROBOT™, see the error code chart below:

<b>ERROR CODE</b>	<b>SOLUTION</b>
<b>All LED lights are off</b>	Unit is turned off. Cycle power switch. If no response, plug in to charge unit.
<b>Red “Replace” LED light is on</b>	Your battery is ready to be replaced. Visit <a href="http://sharkclean.com">sharkclean.com</a> for replacement
<b>DOCK and SPOT alternate flashing</b>	A side brush is stuck. Remove debris from side brushes.
<b>DOCK and SPOT flashing together</b>	Something is stuck in the main brushroll. Remove obstruction.
<b>CLEAN flashing blue</b>	The front wheel sensor, drop sensor, or bumper is reporting an error. Make sure your robot is able to move freely by moving it to a new location on a level surface. Make sure the front bumper is not stuck. If Clean light continues to flash blue, remove the front wheel and clean the wheel cavity.
<b>SPOT flashing blue</b>	The unit cannot move due to surface or obstruction. Move robot to a new location.
<b>CLEAN flashing red</b>	Cliff sensors are reporting an error. Wipe cliff sensors with a clean cloth. Robot cannot start due to an error. Ensure your robot is on a level surface with no obstructions.
<b>“!” symbol flashing</b>	Suction motor failure. Remove blockages and clean filters. Remove dust bin and make sure nothing is blocking suction.
<b>CLEAN flashing red and “!” stays solid red</b>	Your charger is experiencing an issue. Please contact Customer Service at 1-800-798-7398.
<b>“!” and CLEAN symbols flashing</b>	Your robot’s BotBoundary™ sensors are reporting an error. Please contact Customer Service at 1-800-798-7398.
<b>CLEAN solid red</b>	The dust bin has been removed and needs to be reinserted.
<b>CLEAN solid blue</b>	Your robot is in sleep mode. Press any button on the robot or remote to start it again.

# Shark | NINJA ONE (1) YEAR LIMITED WARRANTY

The 1-Year Limited Warranty applies to purchases made from authorized retailers of **SharkNinja Operating LLC**. Warranty coverage applies to the original owner and to the original product only and is not transferable. Power pack is not covered by 1-year warranty.

SharkNinja warrants that the unit shall be free from defects in material and workmanship for a period of 1 year from the date of purchase when it is used under normal household conditions and maintained according to the requirements outlined in this instruction manual, subject to the following conditions and exclusions.

## What is covered in my warranty?

1. The original unit and/or non-wearable components deemed defective, in SharkNinja's sole discretion, will be repaired or replaced for up to 1 year from the original purchase date.
2. In the rare event that a replacement unit is issued, the warranty coverage ends six months following the receipt date of the replacement unit or the remainder of the existing warranty, whichever is greater. If the unit is replaced, SharkNinja reserves the right to replace the unit with one of equal or greater value.

## What is not covered in my warranty?

Our Customer Service/Product Specialists are available to provide all the warranty service options available to you, including the possibility of upgrading to our VIP Warranty Service Options for select product categories.

1. Normal wear and tear of wearable parts such as foam filters, HEPA filters, pads etc., which require regular maintenance and/or replacement to ensure the proper functioning of your unit are not covered by this warranty.
2. Any unit that has been tampered with or used for commercial purposes.
3. SharkNinja will cover the cost for the customer to send in the unit to us for repair or replacement. A fee of \$24.95 for return shipping costs will be charged at the time of return shipment of the repaired or replacement unit.
4. Damage caused by misuse, abuse, or negligent handling, or damage due to mishandling in transit.
5. Consequential and incidental damages.
6. Defects caused by or resulting from damages from shipping or from repairs, service or alteration to the product or any of its parts which have been performed by a repair person not authorized by SharkNinja.
7. Products purchased, used or operated outside of North America.

## Problems with your unit/How to get service

If your appliance fails to operate properly while in use under normal household conditions within the warranty period, visit [sharkclean.com](http://sharkclean.com) for product care/maintenance self-help. Our Customer Service and product specialists are also available at 1-800-798-7398 to assist with product support and warranty service options.

## How to initiate a warranty claim

You can call 1-800-798-7398 to have a Customer Service specialist assist you. Please note you must call 1-800-798-7398 to initiate a warranty claim. Return and Packing Instruction information will be provided at that time.

For Customer Service hours, visit [sharkclean.com](http://sharkclean.com)

Replacement parts are available for purchase at [sharkclean.com](http://sharkclean.com). For more information on which parts are classified as wearable and non-wearable, please visit [sharkclean.com/warranty](http://sharkclean.com/warranty)

This warranty gives you specific legal rights, and you also may have other rights that vary from state to state.

Some states do not permit the exclusion or limitation of incidental or consequential damages, so the above may not apply to you.

# NOTES

---

---

---

---

---

---

---

---

---

---

---

---

---

---

---

---

---

---

---

---

---

---

---

---

---

---

---

---

# NOTES

---

---

---

---

---

---

---

---

---

---

---

---

---

---

---

---

---

---

---

---

---

---

---

---

---







**SharkNinja Operating LLC**  
**US: Needham, MA 02494**  
**CAN: Ville St-Laurent, QC H4S 1A7**  
**1-800-798-7398**  
**sharkclean.com**

Illustrations may differ from actual product. We are constantly striving to improve our products; therefore the specifications contained herein are subject to change without notice.

SHARK is a registered trademark of SharkNinja Operating LLC.

BOTBOUNDARY and SHARK ION ROBOT are trademarks of SharkNinja Operating LLC.

For SharkNinja U.S. Patent information, visit [sharkninja.com/USPatents](http://sharkninja.com/USPatents)

© 2017 SharkNinja Operating LLC  
RV700Series\_IB\_MP\_170720  
PRINTED IN CHINA



**@sharkcleaning**