

12ft Octagon Bayside Gazebo Assembly Manual with Wind/Snow Load Brackets

Revision #30
December 4, 2020

We recommend reviewing this Assembly Manual thoroughly before starting this project. Become familiar with the tools required and where and when assistants are necessary. If you're planning on finishing the Gazebo in a weekend, we recommend completing up to **Step 41** on your first day.



Thank you for purchasing a 12 ft Bayside Gazebo. Please take the time to identify all the parts prior to assembly. The parts list can be found on Page 2 of this Manual. Sorting parts will help you organize and prepare for each section. There are 7 sections:

- A. Floor Section
- B. Rafter Section
- C. Rail Section
- D. Floor Section
- E. Roof Section
- F. Cupola Section
- G. Miscellaneous Section.



- Snow load ratings vary by geographical location. If heavy or wet snowfall occurs, it is advisable to sweep snow off roof frequently.
- If the product is elevated, any structural and building code requirements are solely the customer's responsibility, and should be abided by.
- In areas with high or gusty wind conditions, it is advisable to install the structure securely to the ground.
- Have a regular maintenance plan to ensure screws, doors, windows and parts are tightly affixed.

Customer agrees to hold Outdoor Living Today and any Authorized Dealers free of any liability for improper installation, maintenance and repair.

In the event of a missing or broken piece, call the Outdoor Living Today Customer Support Line @ 1-888-658-1658 within 30 days of the delivery of your purchase. It is our commitment to you to courier replacement parts, free of charge, within 10 business days of this notification. Replacement parts will not be provided free of charge after the 30 day grace period.

All structures purchased from Outdoor Living Today are covered for a period of one year for defects in manufacturing and workmanship. Costs incurred for customer installations are not included.

Failure to use supplied parts included in this kit could result in poor product performance and may void your warranty. Please contact Outdoor Living Today's Customer Toll Free Line if you plan to deviate from our written instructions.

**Thank you for purchasing our 12ft Octagon Bayside Gazebo Kit.
Please take the time to identify all the parts prior to assembly.**

Parts List

A. Floor Joist Section (Page 4-11)

- 1 - 5 1/4" - Diameter Octagon Core Block
- 8 - 1 1/2" x 5 1/2" x 68 7/16" - Main Floor Joist
- 8 - 1 1/2" x 5 1/2" x 23 13/16" - "T" Post Mount Plate / Main Floor Joist
- 8 - 1 1/2" x 5 1/2" x 53 1/16" - Mid Floor Joist
- 8 - 1 1/2" x 5 1/2" x 13 1/8" - Interior Core Brace - angle cut on ends
- 8 - 1" x 5 1/2"w x 58 3/8" - Outer Rim Joists
- 8 - 3 1/2" x 3 1/2" x 91 1/4" - Posts - Angle Cut on Top / Drilled on Bottom
- 1 - Plywood Post Spacing Template - Angle cut on ends

B. Rafter Section (Page 12-14)

- 8 - 3 1/2" x 3 1/2" x 74 1/8" - Corner Rafters (30 & 22 1/2 degree cut)
- 8 - 3 1/2" x 3 1/2" x 70" - Mid Rafters (31 degree cut both ends)
- 8 - 1 1/2" x 6" x 14 7/8" - Octagon SkyBox (Cut,Dado and Drilled)

C. Rail Section (Page 15-19)

- 7 - 53 13/16" x 36" - Hand Rail Section
- 14 - 5/8" x 3 1/8" x 40" - Hand Rail End Caps - Dog Ear and Router edges.
- 8 - 53 13/16" x 10" - Upper Rail Section
- 8 - 5/8" x 3 1/8" x 15 1/4" - Upper Rail End Caps -Right Side (Angle Cut One End with Hole)
- 8 - 5/8" x 3 1/8" x 15 1/4" - Upper Rail End Caps -Left Side (Angle Cut One End with Hole)

D. Floor Section (Page 20-23)

- 8 - Pre-assembled Deck Floor Panels - Triangular Shaped
- 8 - 1" x 5 1/2" x 60 7/8" - Perimeter Deck Board- notched for Post
- 8 - 1" x 5 1/2"w x 14 1/8" - 2nd to last Deck Board
- 8 - 1" x 5 1/2"w x 9 1/2" - Last Deck Board
- 1 - 1" x 12" - Octagon Center Deck Piece

E. Roof Section (Page 24-29)

- 16 - Roof Panels (8 left / 8 right)
- 16 - 1 1/2" x 5 1/2" x 22 5/8" - Corner Brackets - 8 left / 8 right
- 8 - Facia Boards - 1" x 4 1/2" x 64 7/8" long - Angle Cut on Ends

F. Cupola Parts List (Page 30-34)

- 8 - Side Rail Sections
- 1 - Small Core Block- Octagon
- 8 - 1 3/8" x 1 3/8" x 24" - Rafter - (Angle Cut Both Ends)
- 8 - 3/4" x 1 1/2" x 18" - Facia
- 8 - Small Roof Panels
- 24 - Cupola Ridge Caps (2 1/2' wide "V" shaped) 8 - 16" long / 8 - 14 1/2" long / 8 1/2" - 10" angle ends
- 1 - Top Cap & Ball Top

G. Miscellaneous Section (Page 35-37)

- 48 - Filler Shingles- Main - 5 1/2" x 16"
- 8 - Filler Shingles - Top - 5 1/2" x 8 1/4"
- 8 - Facia Corner Detail Plates (Small)
- 8 - Rim Joist Corner Detail Plates (Large)
- 88 - Ridge Cap Shingles - (8 caps cut to 10" long for row against cupola)

12' BAYSIDE GAZEBO HARDWARE SHEET

Hardware Kit (Provided)

In Florida, additional hardware may be required that is not included in kit due to hurricane winds. Please check with local building code to confirm.

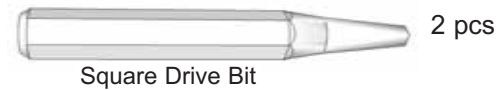
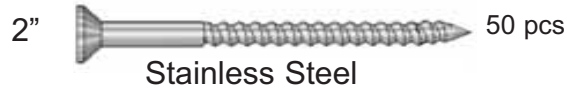
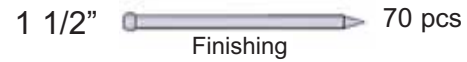

Tools Required (Not Provided)



Safety Equipment Required (Not Provided)



A. Floor Section

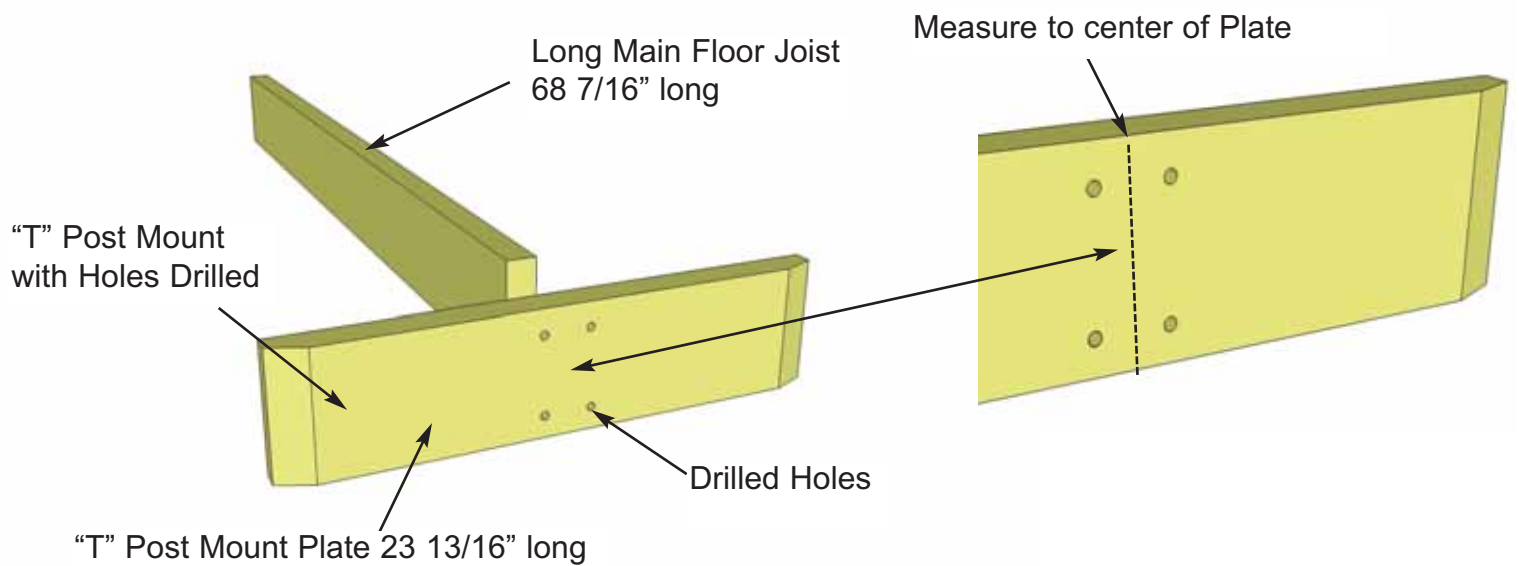

1. Locate both the **Long Main Floor Joist** and the **"T" Post Mount Plate**. **Angle cut ends must be positioned to the outside.** Pre-drilled holes will align with Posts later in **Step 10**. Please review this step to confirm correct "T" Post Mount Plate orientation. Use 4 - Carriage Bolts to align Joist with "T" Plate prior to attaching. Joist must be evenly spaced between bolts. Remove Carriage Bolts when correctly aligned.

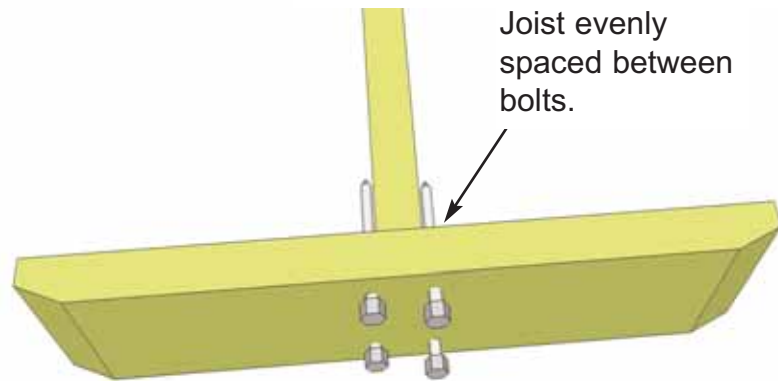

2. With pieces properly orientated, screw "T" Plate and Joist together with 2 - 3" screws. Make sure pieces are flush with each other on the top and bottom. Complete all 8 Long Main Floor Joist and "T" Post Mount Plate Connections. Once again, check alignment prior to attaching together.

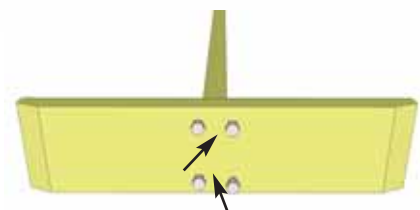

3. Locate the 5 1/4" Diameter Octagon **Core Block**. Place at end of one of the Long Main Floor Joists.

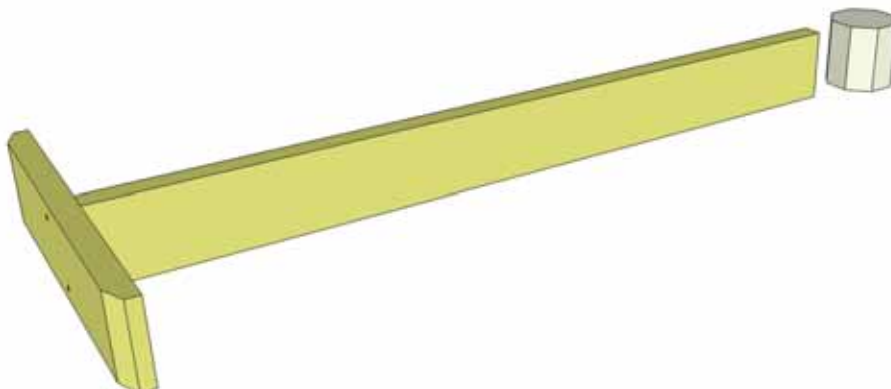

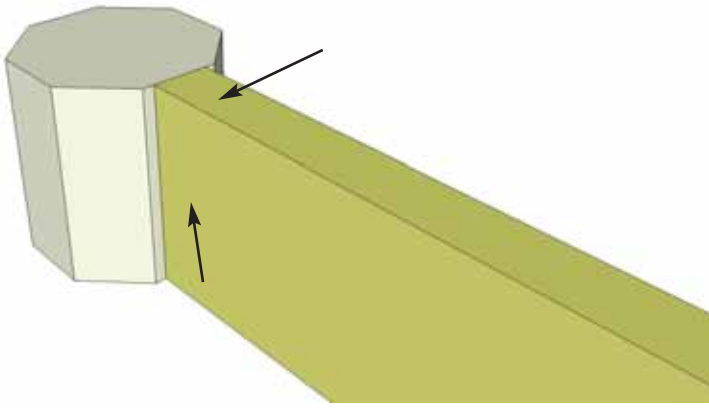

4. Position end of joist equally on one side of the Core Block. Angle screw with 3 - 3" screws from the top and sides. Joist and top of Core Block should sit flush with each other.

Note, Drill 1/8" pilot holes in joist prior to screwing to prevent splitting.

5. Lay completed Core Block / Joist Assembly on flat level surface.

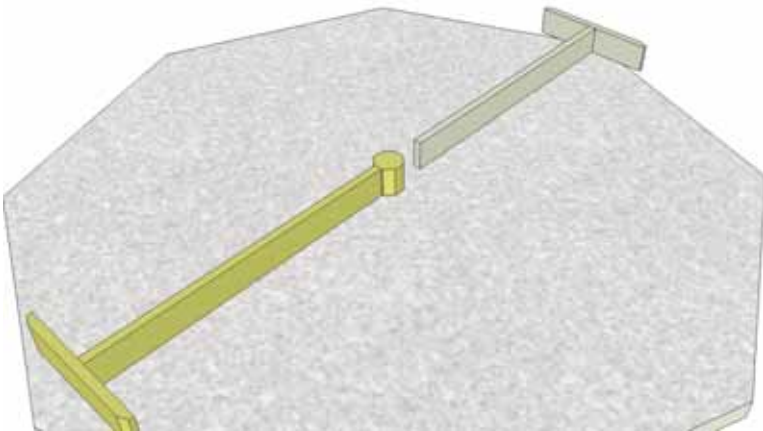
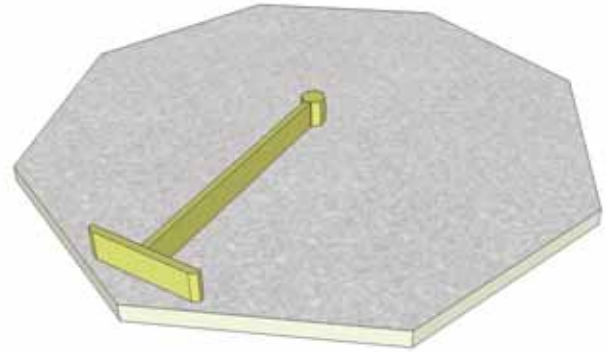

6. Position and angle screw the second joist assembly to opposite side of Core Block.

7. Continue to add Joist Assemblies to Core Block.

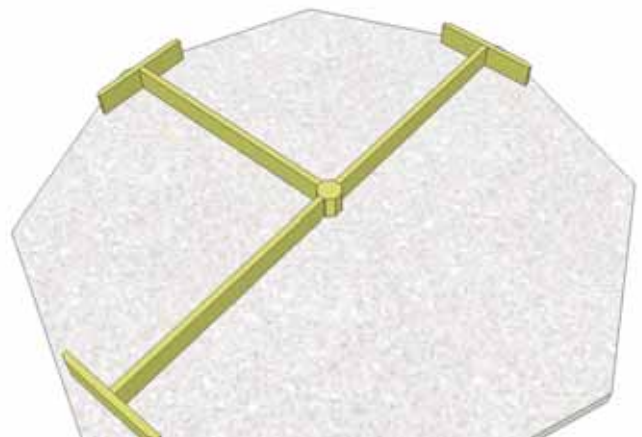

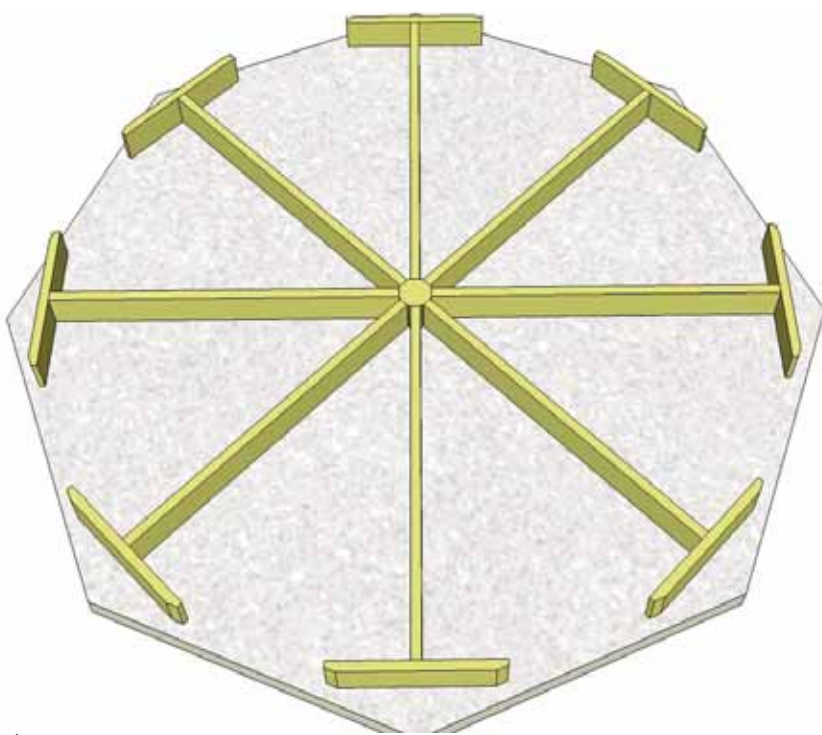

8. At this stage, your gazebo floor should look similar to the illustration to left.

Important: To confirm Doorway location, refer to **Step 16.**

Mid Floor Joist

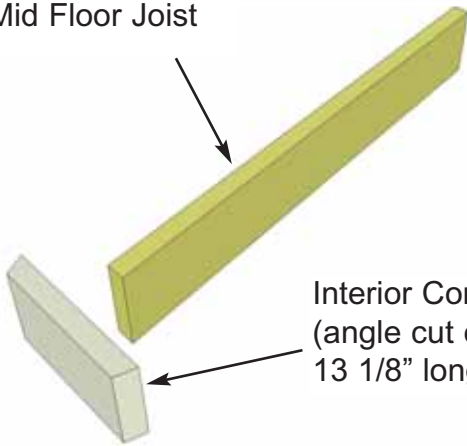

Interior Core Brace
(angle cut on ends)
13 1/8" long

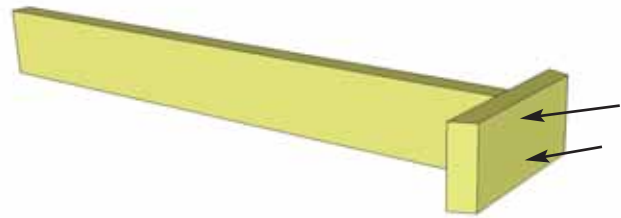

9. Locate and position a **Mid Floor Joist** (53 1/16" long) and an **Interior Core Brace** (13 1/8" long). Make sure the longer side of Core Brace is flush with the end of the joist and attach together with 2 - 3" screws. Once again, make sure Core Brace is centered and flush with joist. Complete all 8 attachments.

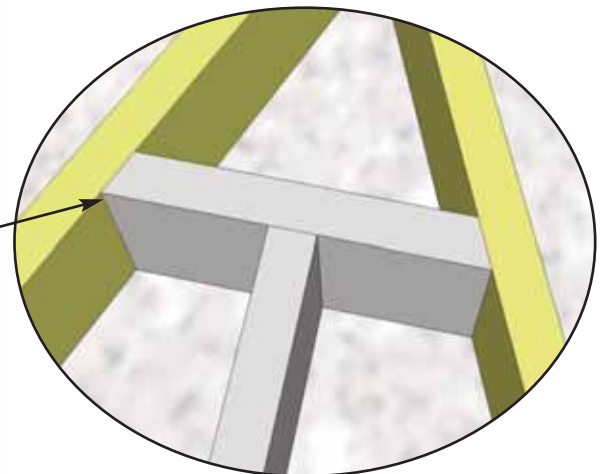
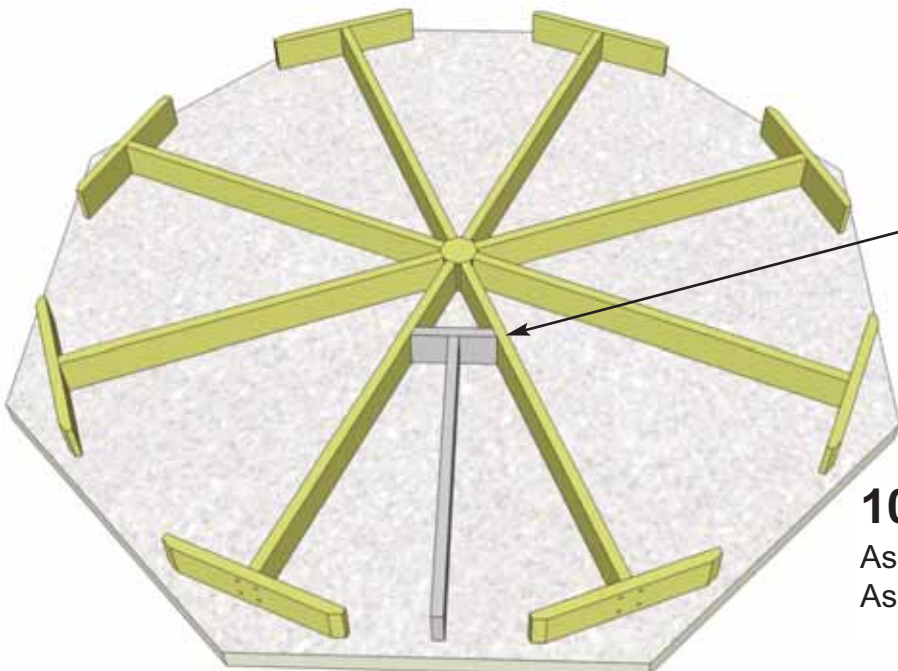

10. Set completed Mid Joist / Core Brace Assembly between the main Joist Assemblies but do not attach.

Outside Core Brace
to center core block
= 17.75".

Do not
attach until
Step 22.

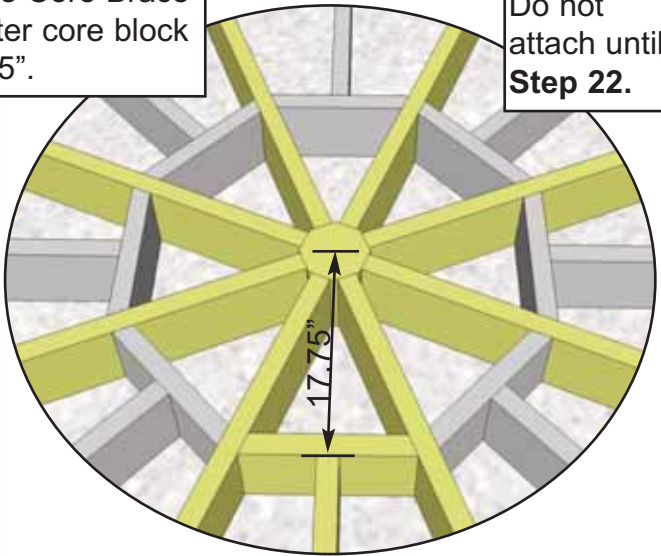
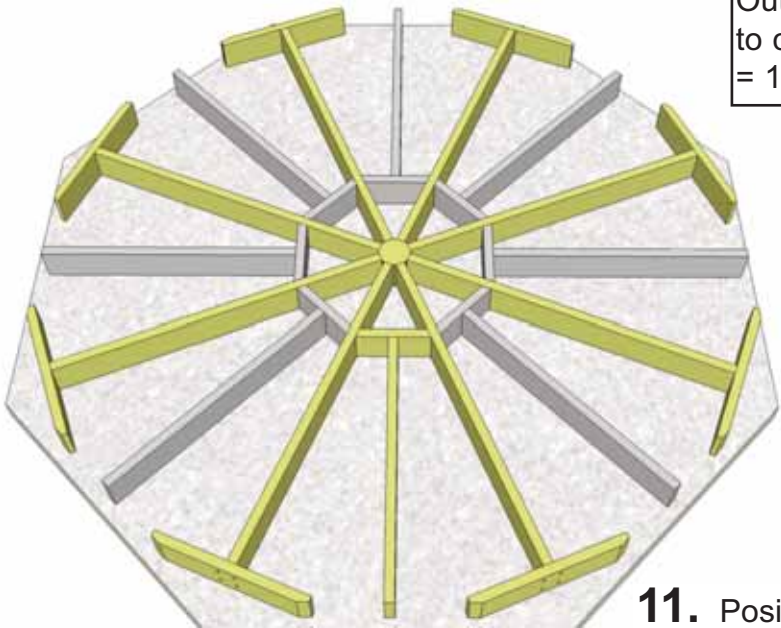

11. Position remaining Mid Joist / Core Brace Assemblies roughly between the main Joist Assemblies. Some adjusting will be necessary to form a symmetrical pattern.

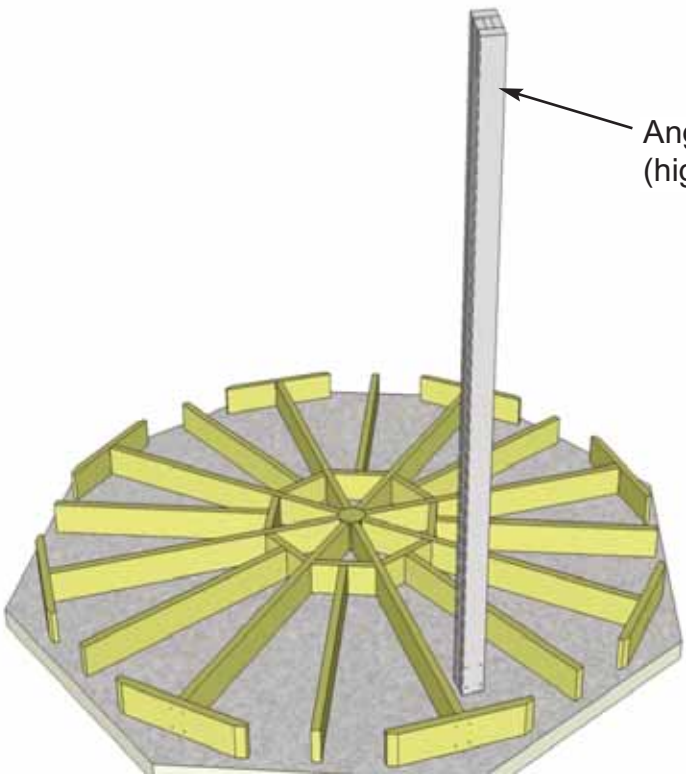

Angle Cut of Post
(high side = inside)

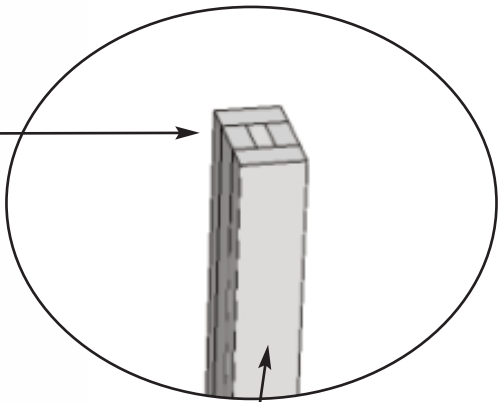

12. Locate 3 1/2" x 3 1/2" Posts. Align first Post with four drilled holes in bottom aligned with "T" Post Mount Plates.
Important: Be sure to align Post so top angle cut is high to the inside.

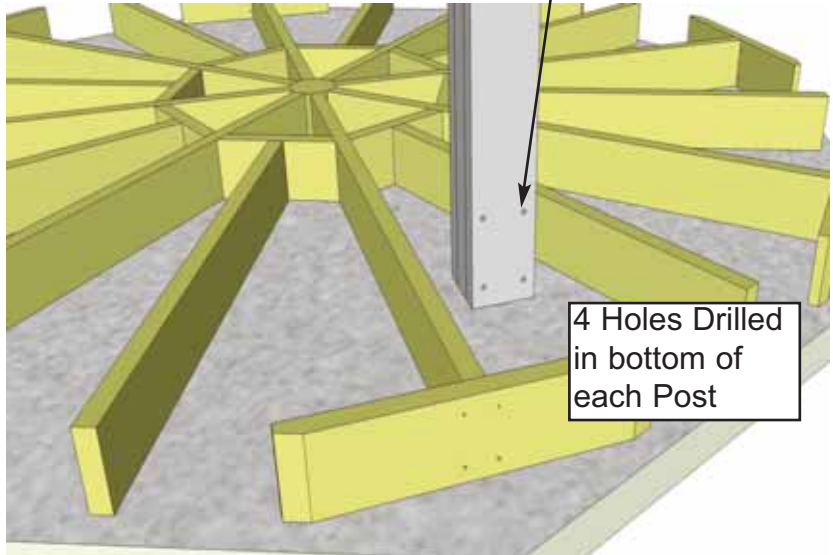

4 Holes Drilled
in bottom of
each Post

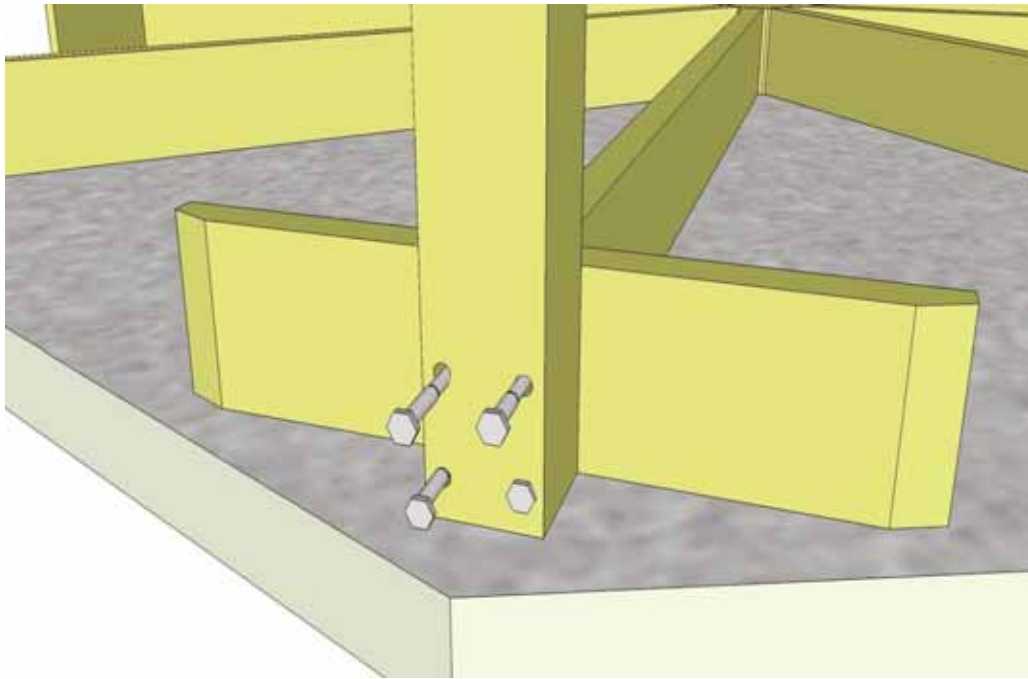

13. When holes are aligned, slide 4 - Carriage Bolts from the outside through Post and "T" Post Mount Plates.

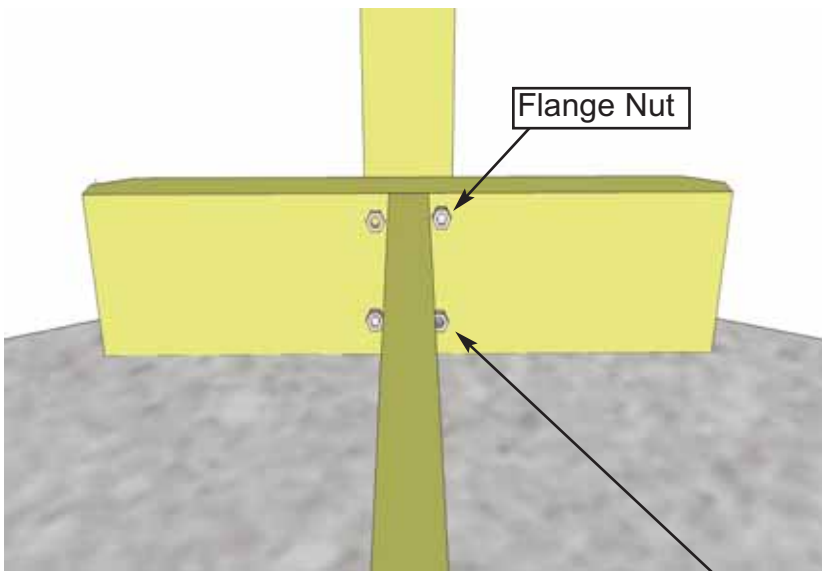

14. Complete all four "T" Post Mount and Post Carriage Bolt attachments.

Important:

Once again, only snug Carriage Bolts at this stage. After Handrail and Upper Baluster Section are installed, come back and firmly tighten with wrench.

15. From the inside, slide a Flange Nut over bolt and tighten.

Important:

Only snug Carriage Bolts at this stage. After Handrail and Upper Baluster Section are installed, come back and firmly tighten all Carriage Bolts with a wrench.

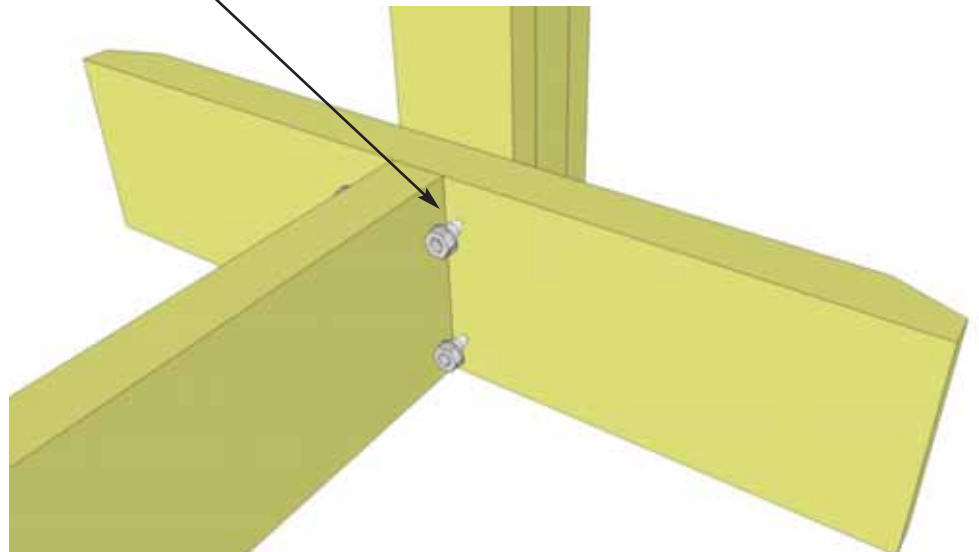

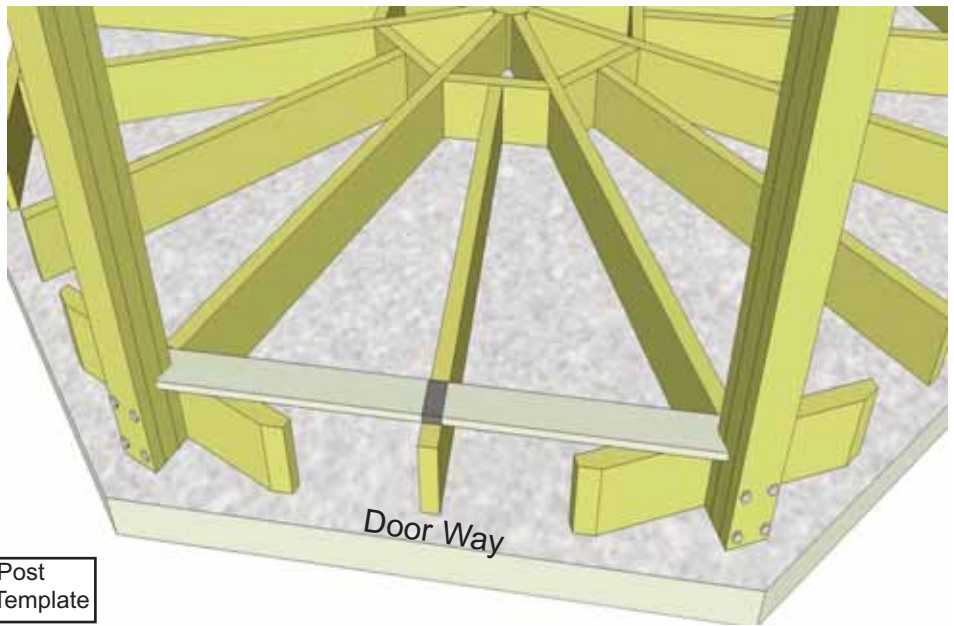
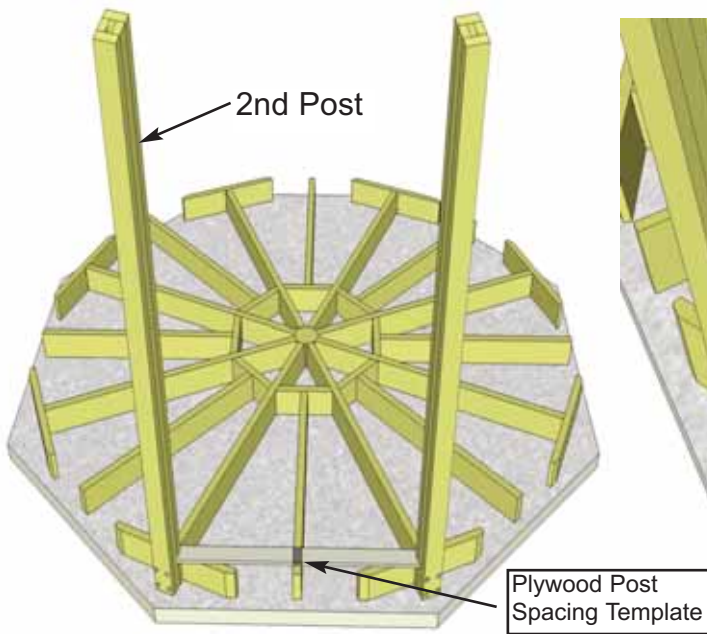

16. Locate 2nd Post and Plywood Post Spacing Template. Align and secure Post to Joist Assembly as per **Steps 12-15**. Using the Post Spacing Template, slide between posts as illustrated above.

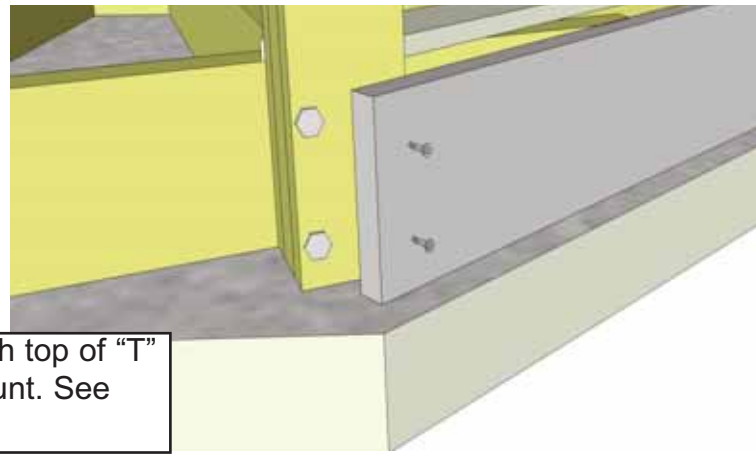
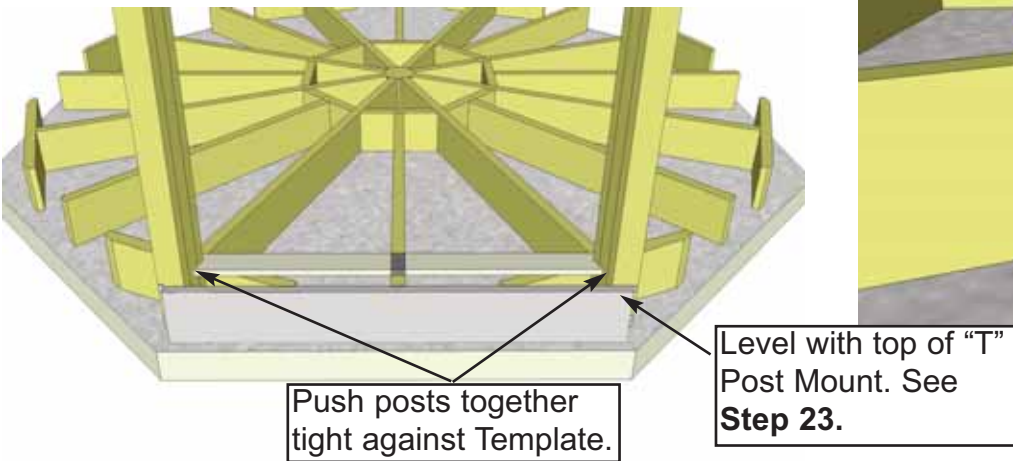

17. Locate one Outer Rim Joist (1" x 5 1/2" x 58 3/8") and position evenly from side to side between each Post. Level Rim Joist with top of "T" Post Mount. Screw Rim Joist to Post with 2 - 3" screws.

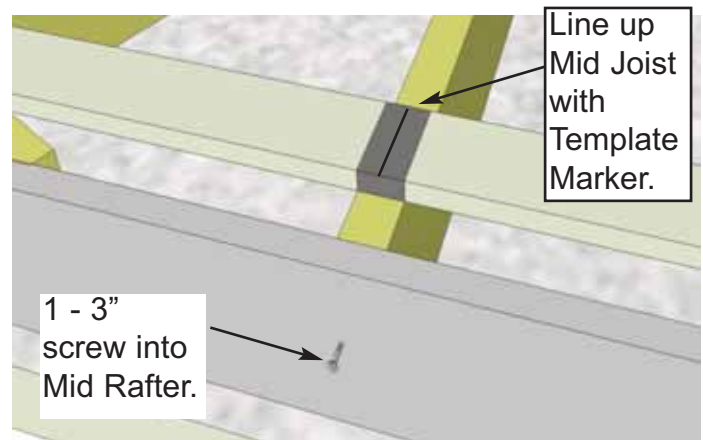
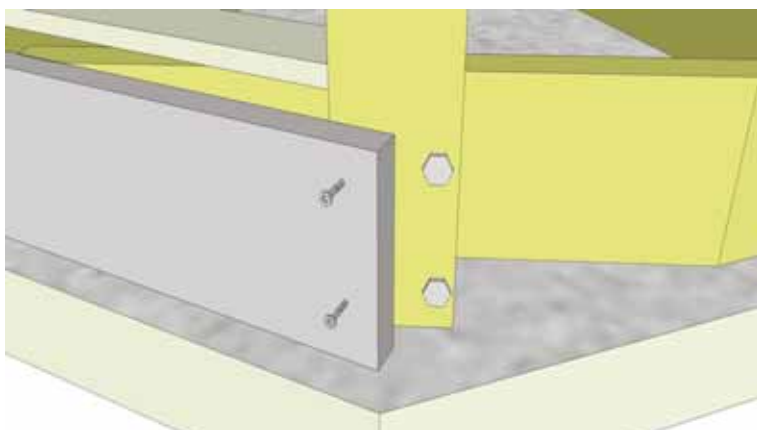

18. Before attaching opposite end of Rim Joist to Post, push Post tight against Template and then attach Rim Joist to Post with 2 - 3" screws. Line up Mid Joist with Mid Joist Template Marker and when correctly centered attach Mid Joist to Rim Joist with 1 - 3" screw.

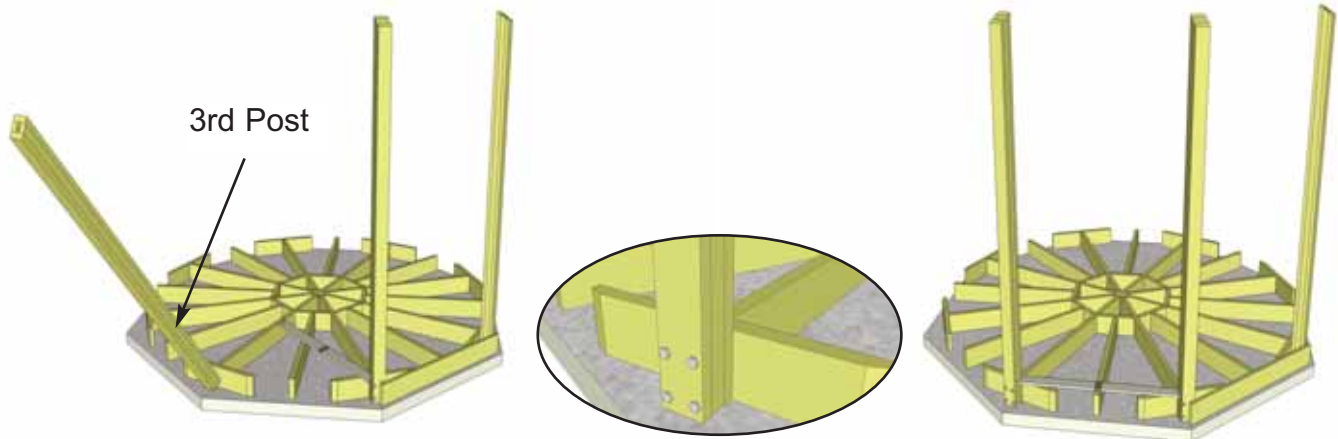

19. Locate 3rd Post. Align and secure Post as per **Steps 12-15**. Using the Post Spacing Template, position 3rd Post as per **Step 16**.

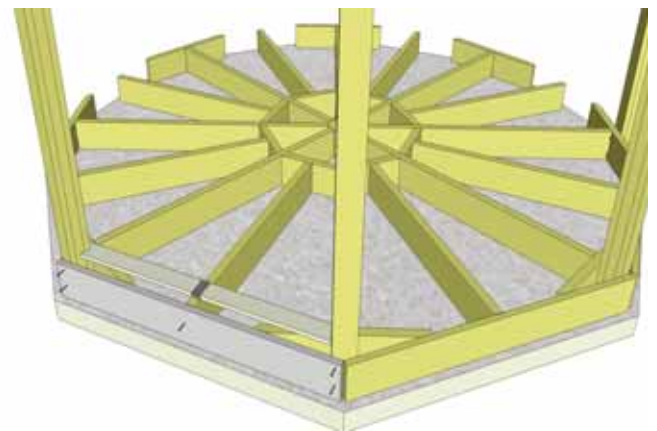
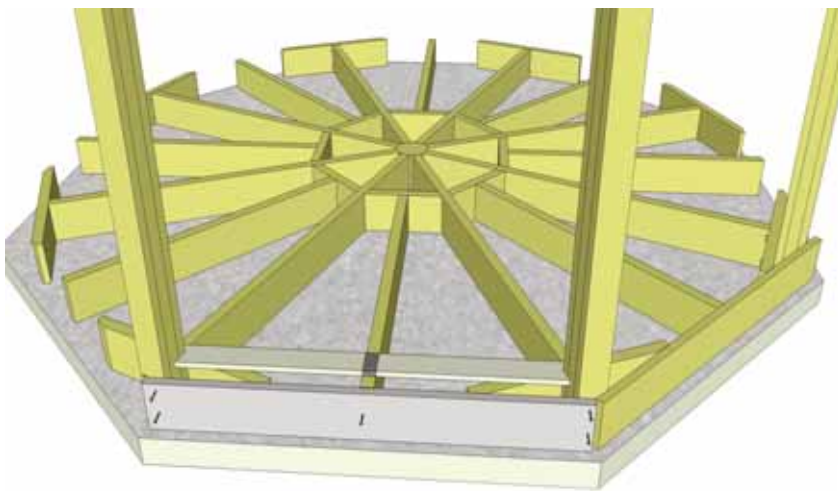

20. With 3rd Post correctly positioned, align and attach the Outer Rim Joist as per **Step 17 - 18**.

Any gaps between the ends Rim Joists will be covered by Rim Joist Detail Plates in Step 121.

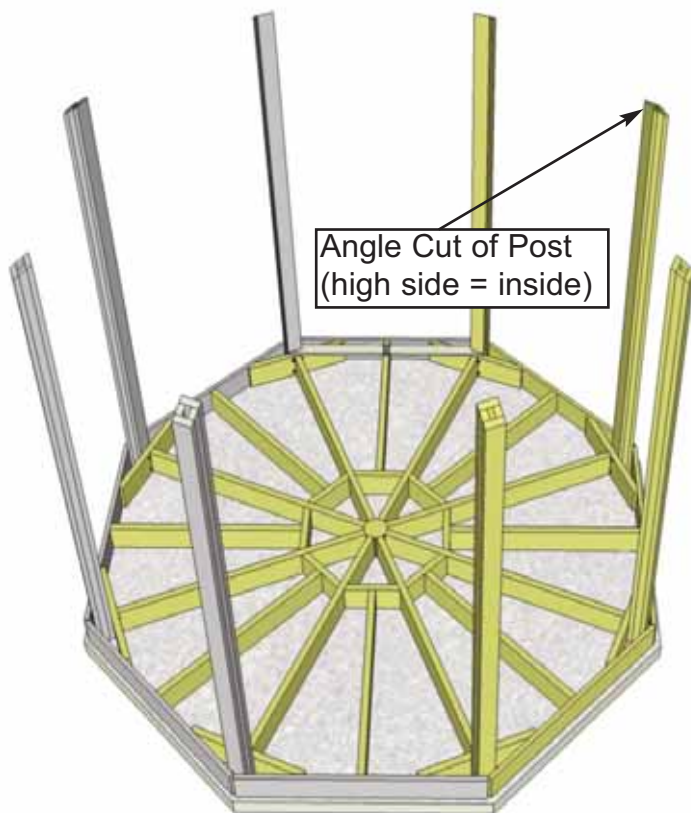

21. Continue to attach Posts and Outer Rim Joists until all 8 are complete. Continue to use Post Spacing Template to confirm correct spacing. **Remember-** Align Post with high side to the inside.

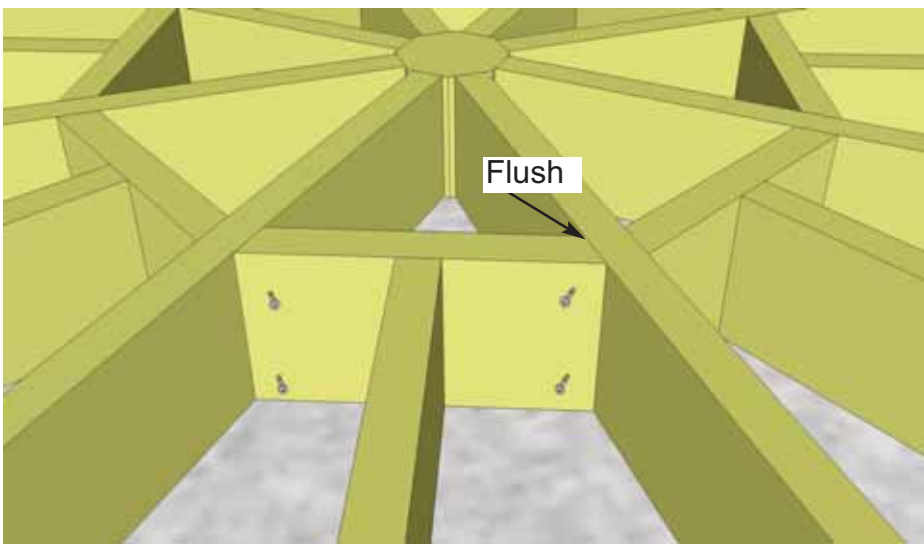

22. Secure Core Brace Assembly to Main Joists with 4 - 3" screws. Make sure tops of Interior Core Brace and Main Joists are flush with each other as Decking will sit on this attached in **Steps 50-64.**

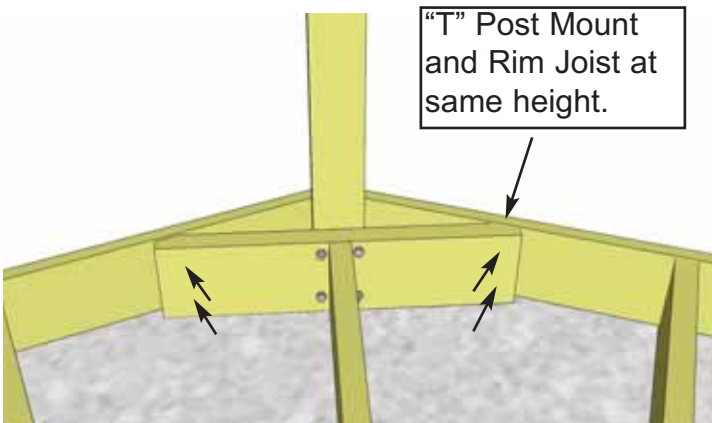

23. With all Mid Joist Assemblies secured, screw the "T" Post Mount into Rim Joist from inside with 2 - 3" screws on angles. Be careful to screw on angle so fastener does not come through Rim Joist. Complete all 8 sides.

Important:
 Use a level to confirm all Floor Joists are level and that the overall Floor is level. Adjust as necessary. Support Floor Structure as required.
 Make sure that Posts are plumb. Check each Post in both directions with a level and adjust as required.

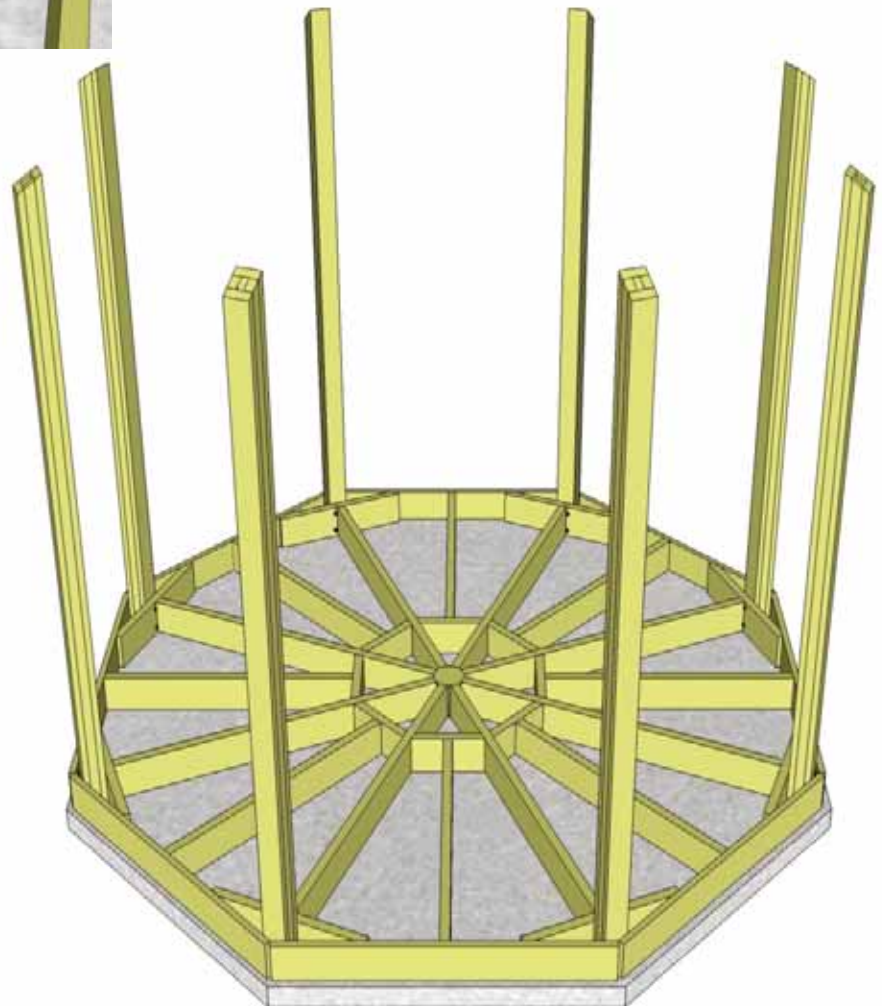

B. Reinforcing Wind & Snow Rafter Brackets

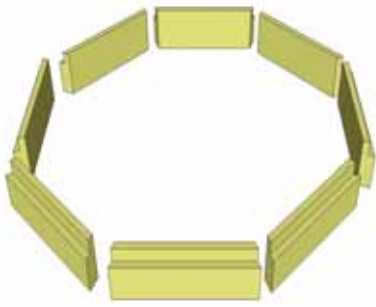

24. Locate 8 Skybox Pieces placing them with Dado cut facing out and to the top.

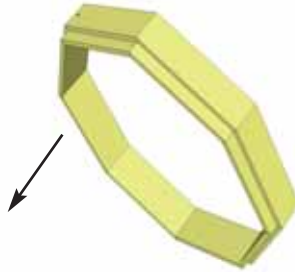
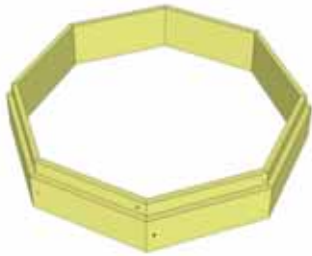

Caution - Next you will be installing Rafters. Rafters will be unstable until Upper Rails Sections are completed in **Step 34**. Rafters must be secured to Upper Rails and cannot be left unattended.

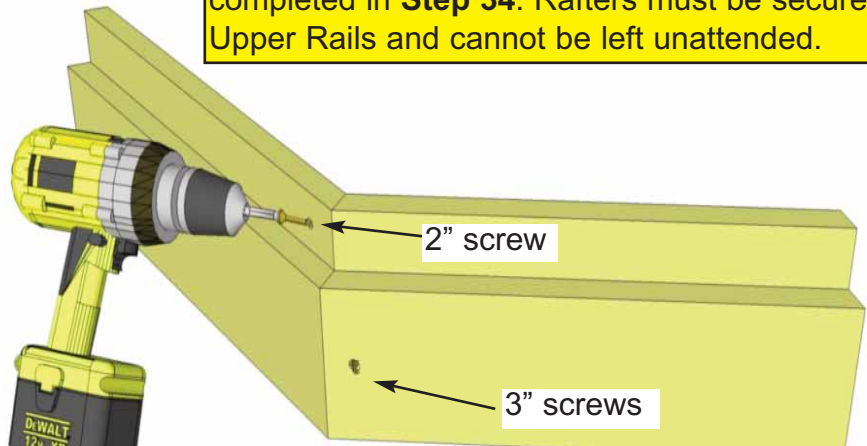

25. Position 2 pieces together so angle cut ends line up. When correctly aligned, screw together using 1 - 3" screw and 1 - 2" screw in top dado ledge as shown in above illustration. Attach remaining pieces to complete Skybox. Flip Skybox over when complete.

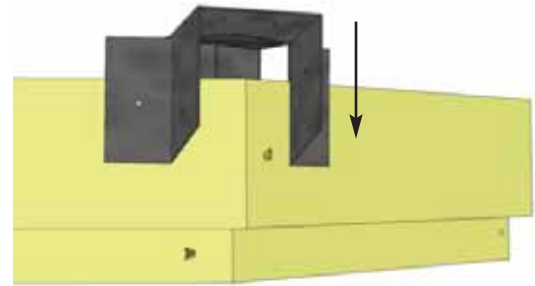
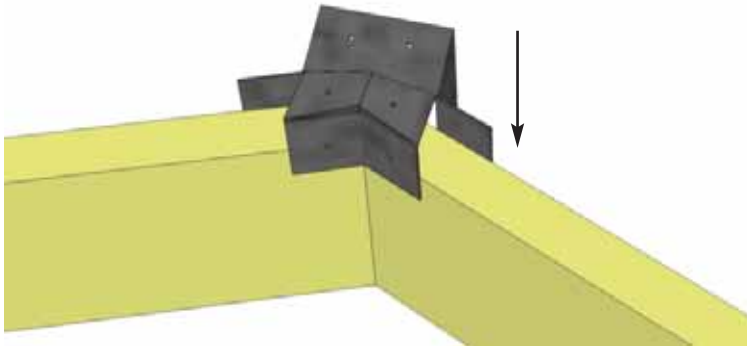

26. Position Wind and Snow Load Roof Rafter Bracket on to Skybox as shown above. Screw bracket with 1 1/4" screws into pre-drilled holes of bracket in sides, edge and back. Make sure bracket is aligned evenly and flush with wood in each corner before fastening.

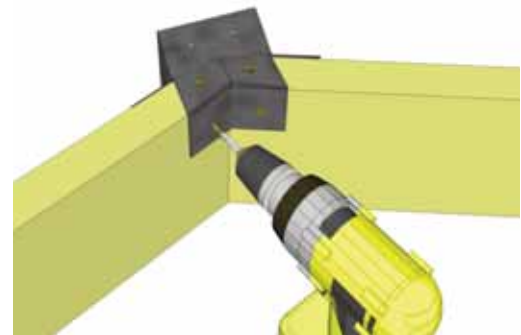
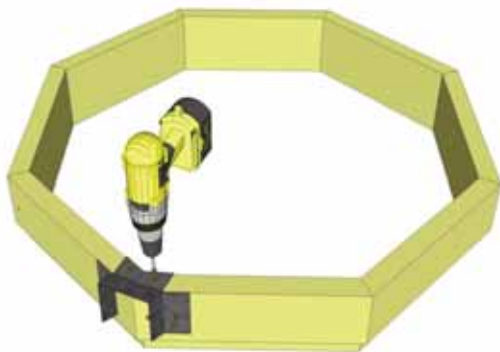

Important - Depending on the # of helpers you have available will determine how many rafters can be attached to Skybox prior to lifting up. Our illustration shows 3 Rafters = 2 additional helpers.

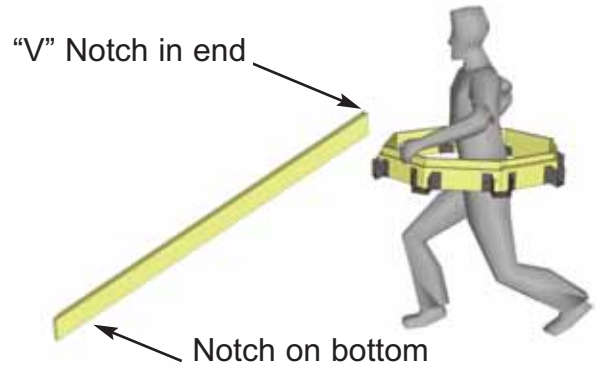
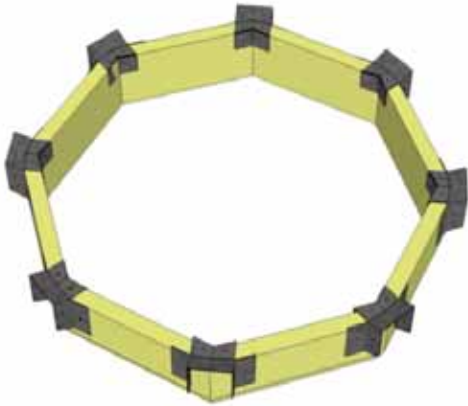

27. Complete all Wind and Snow Load Rafter Bracket connections. Have your helper flip the Skybox over and hold with brackets facing down. Locate a Corner Rafter and align notch down and "V" end to Skybox.

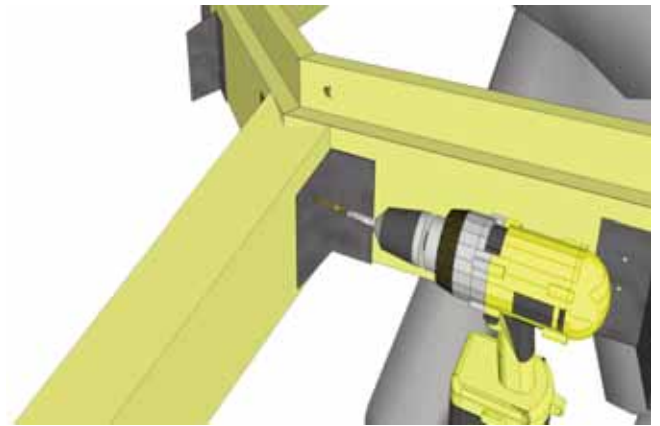
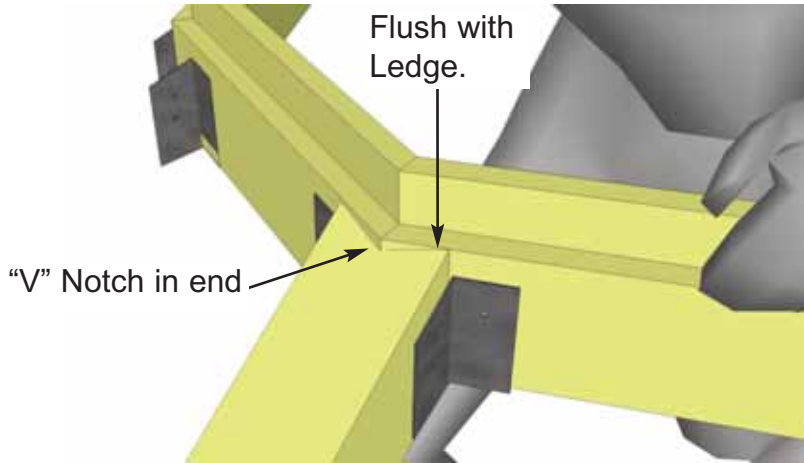

28. Slide Corner Rafter into bracket so bottom of rafter sits tight with bottom of bracket. The top of "V" notch tips should sit even with the skybox ledge. The rafter "V" should be tight against the skybox. When aligned correctly, screw from sides into the Rafter with 1 1/4" screws. Do both sides.

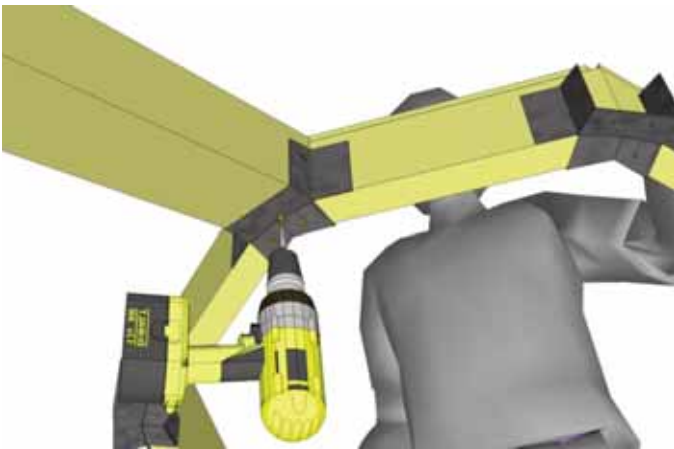

29. From underneath, screw bracket and corner rafter together with 2 - 3" screws. With your helper still supporting the Skybox/ Rafter Assembly, position and attach a second and third rafter as illustrated in **Step 28**.

Important - Prior to lifting Rafters onto Posts, Upper Rails in **Step 34** must be completed.

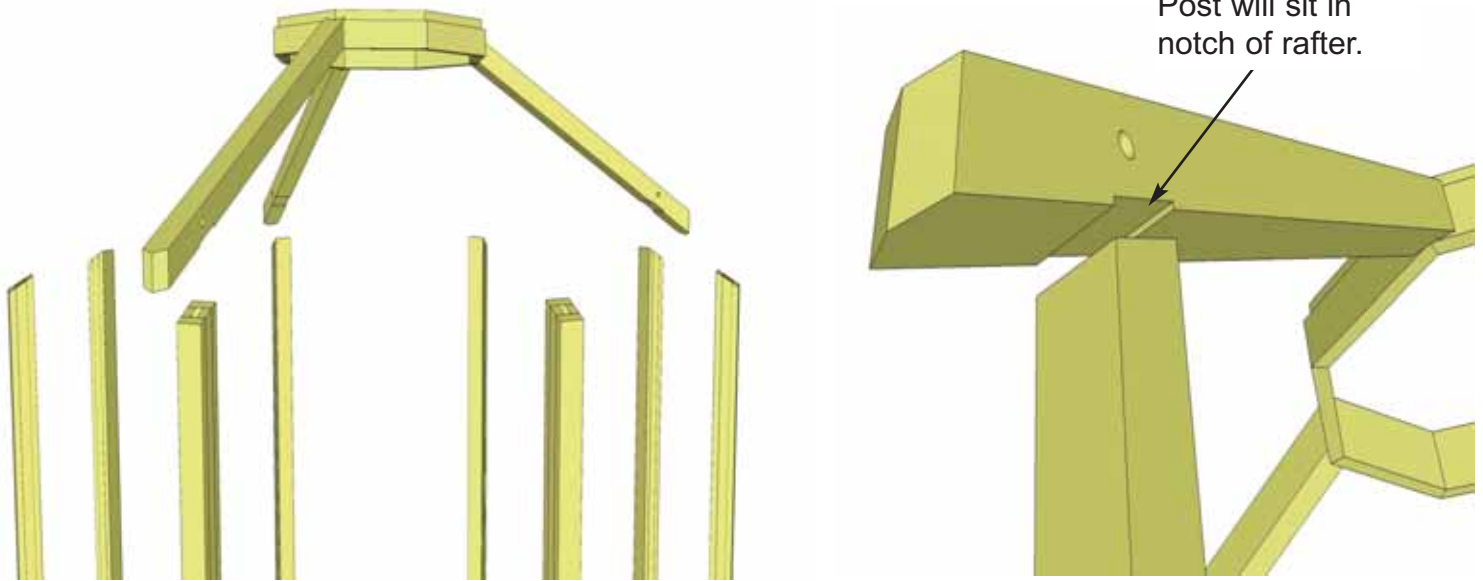

30. With the help of at least 2 assistants and Step Ladders, lift up your partially completed Skybox/Rafter Assembly and place Rafters on top of Posts. The Post will sit in the notch of the Rafter.

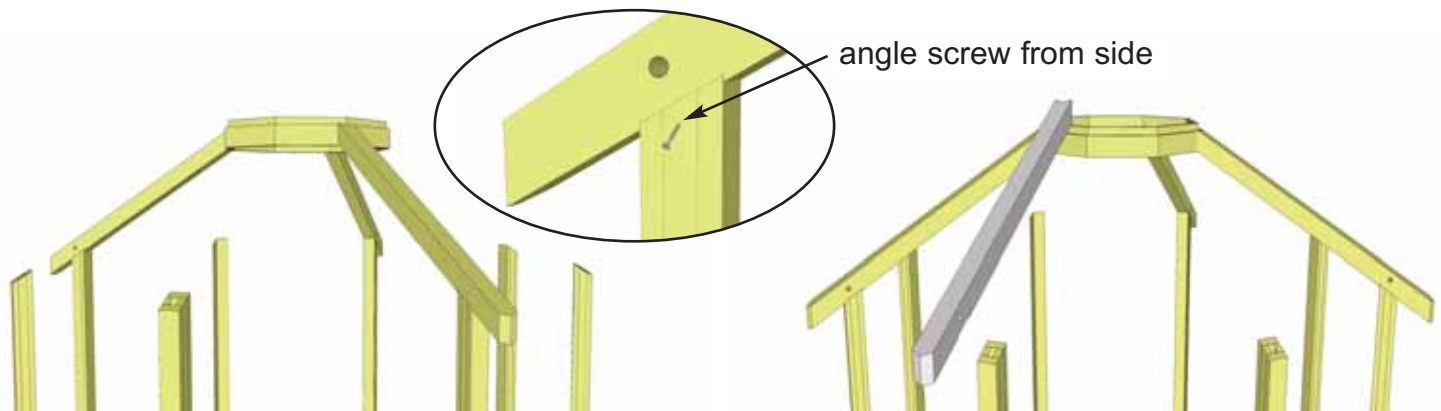

31. Angle screw each Rafter/Post connection together with 1 - 3" screw from Post into Rafter. Slightly countersink screwhead.

32. Standing on ladders, position and attach a 4th Rafter to the Skybox and Post as per **Step 27** and **Step 31**. Remember to align the Rafter correctly with Skybox ledge.



33. Complete remaining Rafter attachments and secure as per **Step 27** and **Step 31**.

C. Rail Section

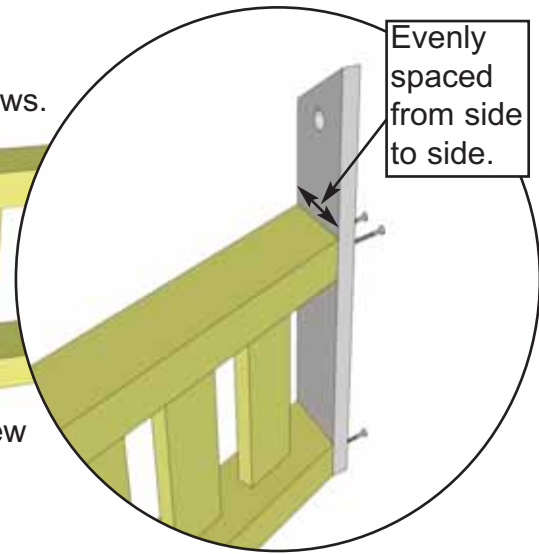
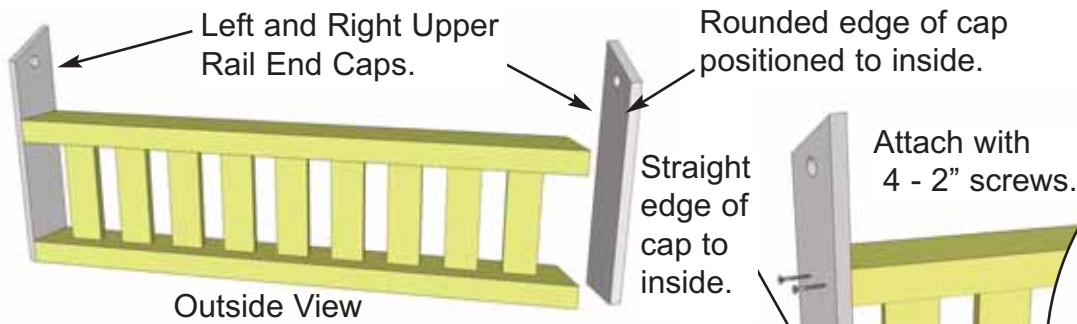

34. Locate Upper Rail Sections (8) and Upper Rail End Caps (8 left / 8 right). Align Caps on Rail Section flush at the bottom and evenly spaced from side to side. See Pictures to the right to confirm alignment prior to attaching.

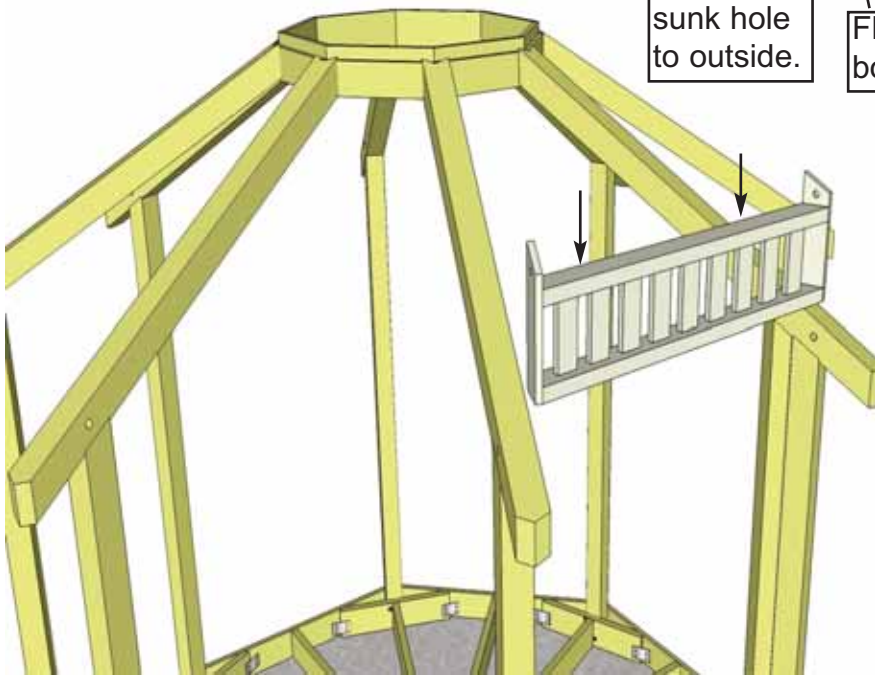

Important- Left and Right Upper Rail Ends Caps must be aligned correctly. Upon completion of first Rail Section, test fit Section as per **Step 35**.

35. Lift a completed Upper Rail Section up and place between the Rafters and Posts. Once Upper Rail alignment is confirmed, complete remaining Upper Rail Assemblies.

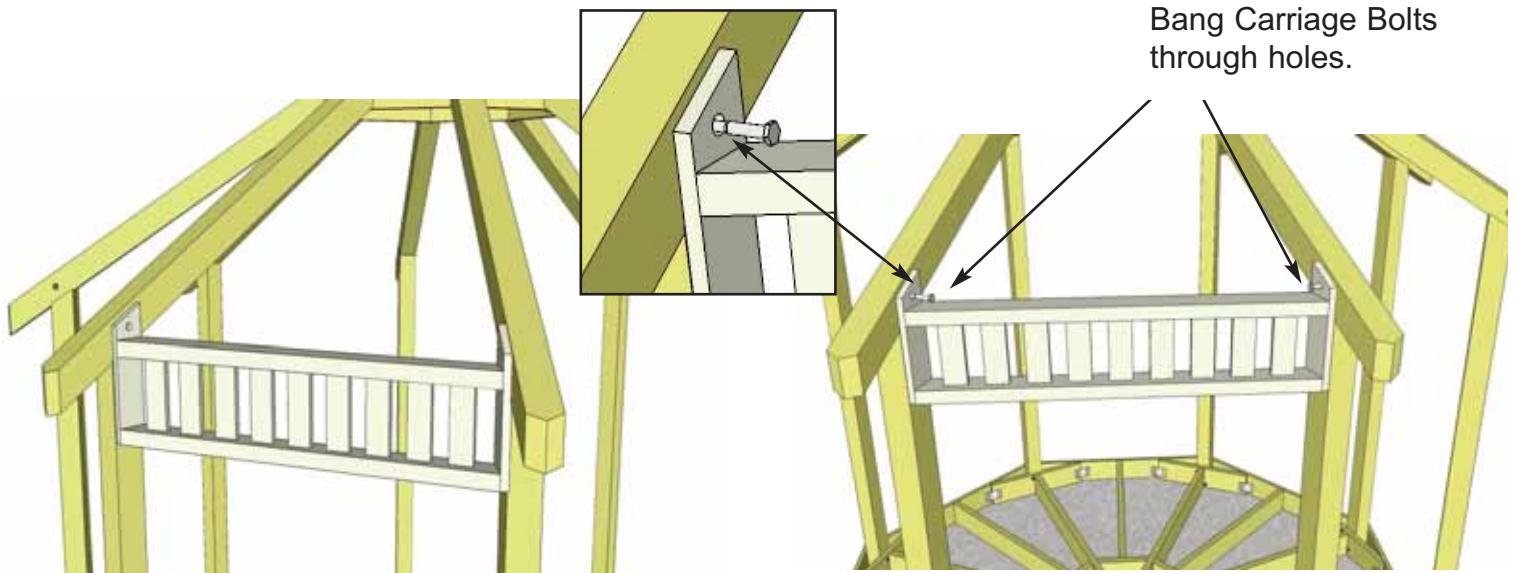

36. Position Upper Rail Section so Pre-drilled holes in End Caps line up with Pre-drilled holes in Rafter. With holes aligned, carefully hammer Carriage Bolt through Upper Rail Section and Rafter. Do not secure washers and nuts of Carriage Bolts until **Step 37**.

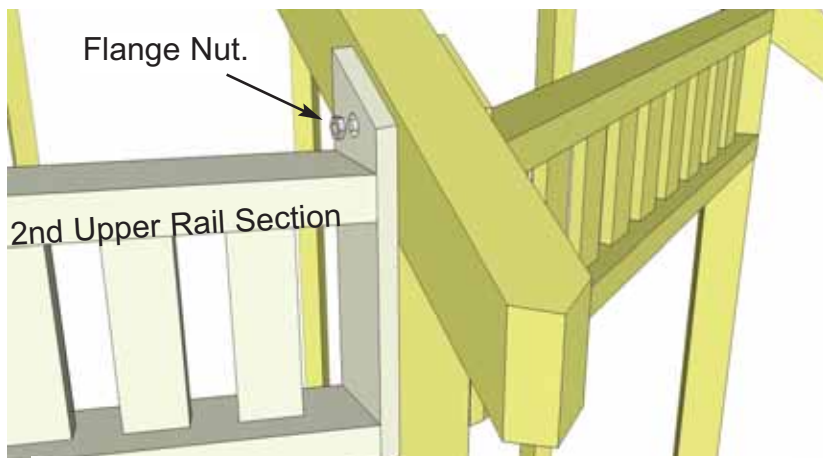

37. Lift a second Upper Rail Section into place and slide carriage bolt through End Cap hole. Place a flange nut over bolt and snug nut down.

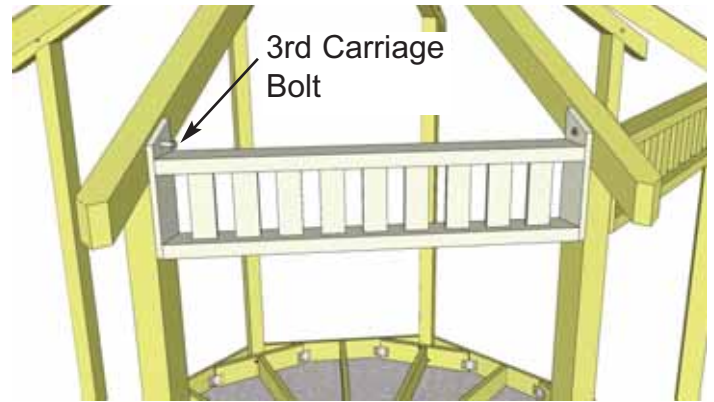

38. Hammer in 3rd Carriage Bolt into left side of second Upper Rail Section as per **Step 36**.



39. Lift up, position and secure all remaining Upper Rail Sections using **Steps 36-38**. **Important - Snug Bolts down but don't over-tighten.**



40. On your last Upper Rail Section, use Carriage Bolt from the first section to secure. Use Wood Clamps or have assistant push Rail / Rafter together.

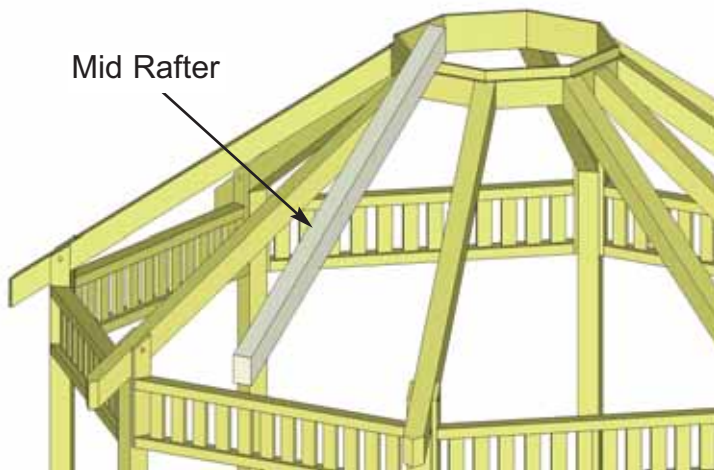

42. Lift and position a **Mid Rafter end** (66 9/16") flush against Skybox. Use a straight edge to confirm same height as Corner Rafters. Position Mid Rafter centered on Skybox. When correctly positioned attach rafter to Skybox with 2 - 3" screws (screw from inside Skybox).

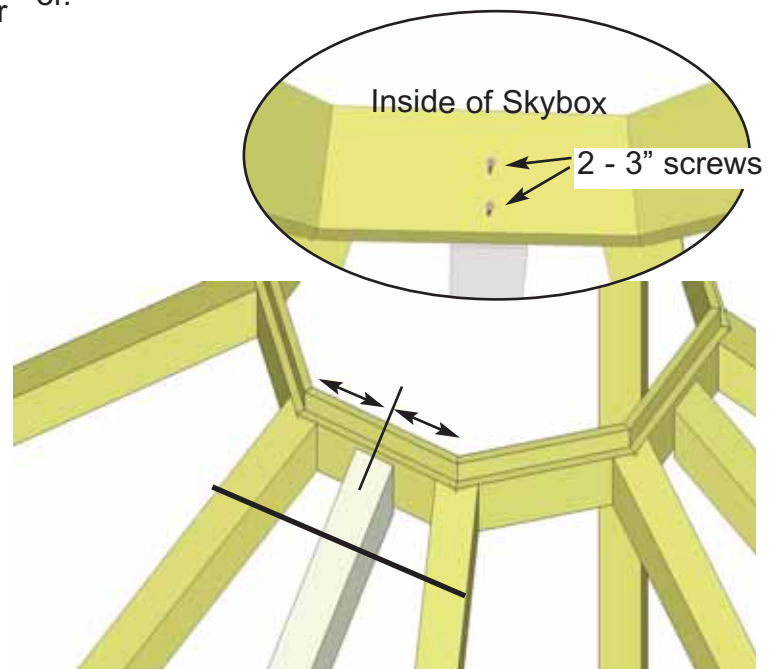

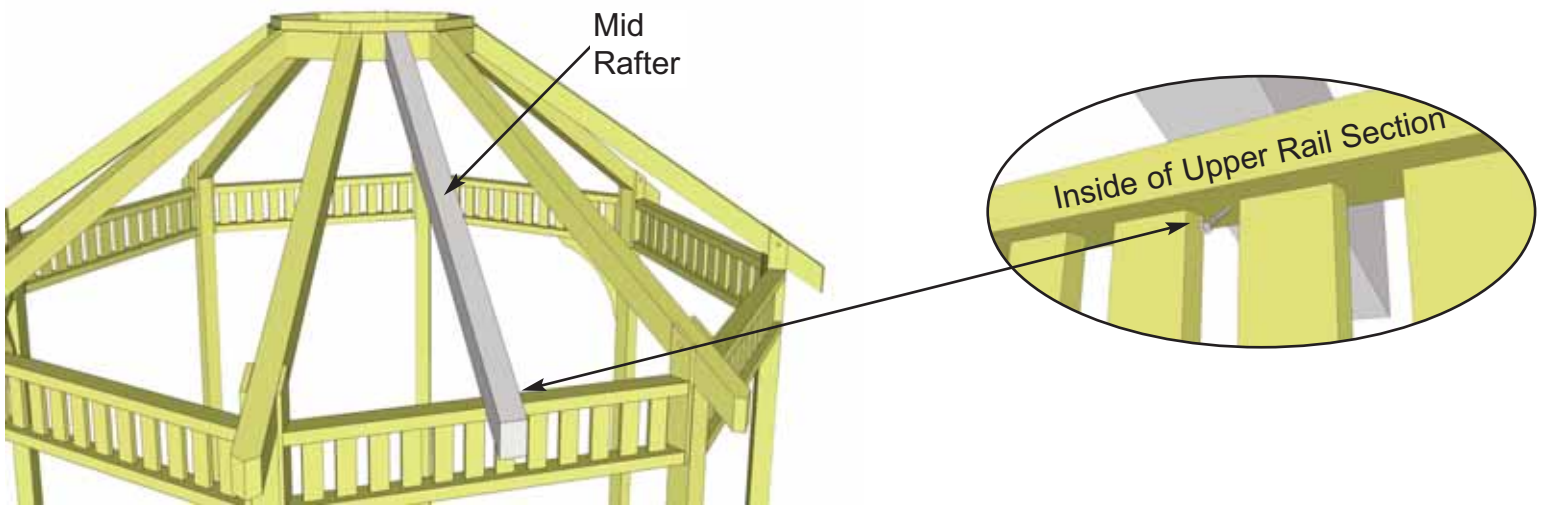

43. Center Mid Rafter on Upper Rail Section (the midpoint of the Upper Rail Sections is approximately 25 1/2" measured from the inside on the Upper Rail). From the inside, angle screw a 3" screw from Upper Rail Section into bottom of Mid Rafter.

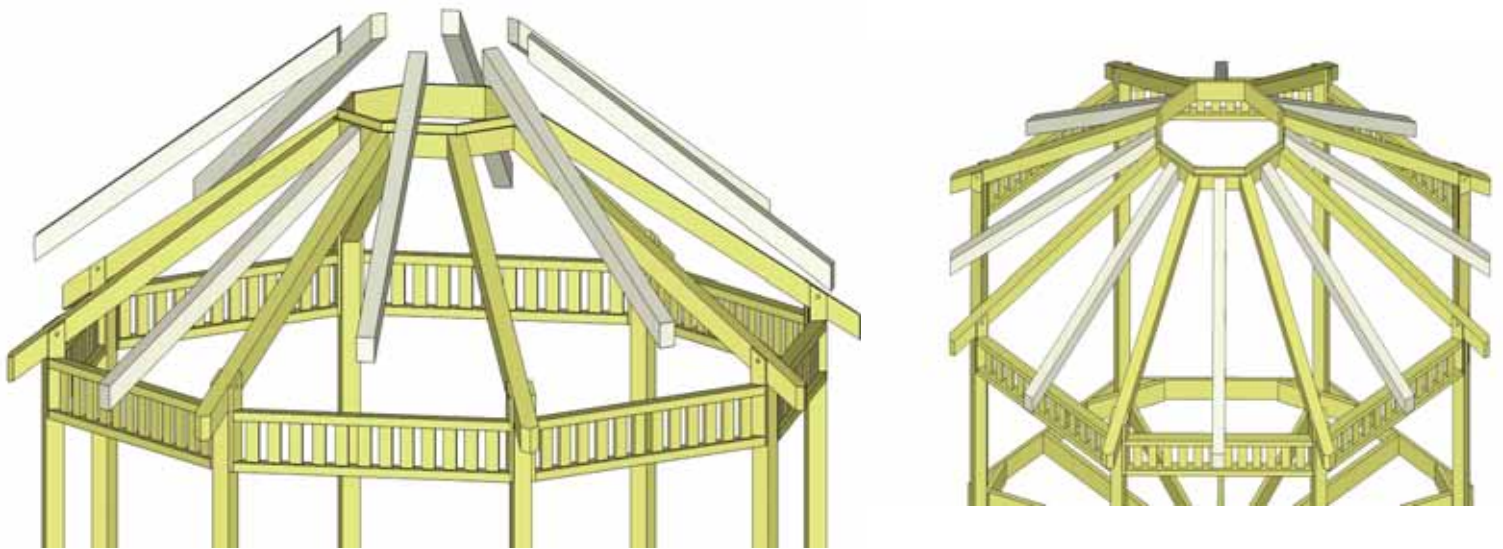

44. Complete remaining 7 Mid Rafters following **Steps 42 -43.**
Important- make sure each rafter is properly positioned from side to side and up and down.

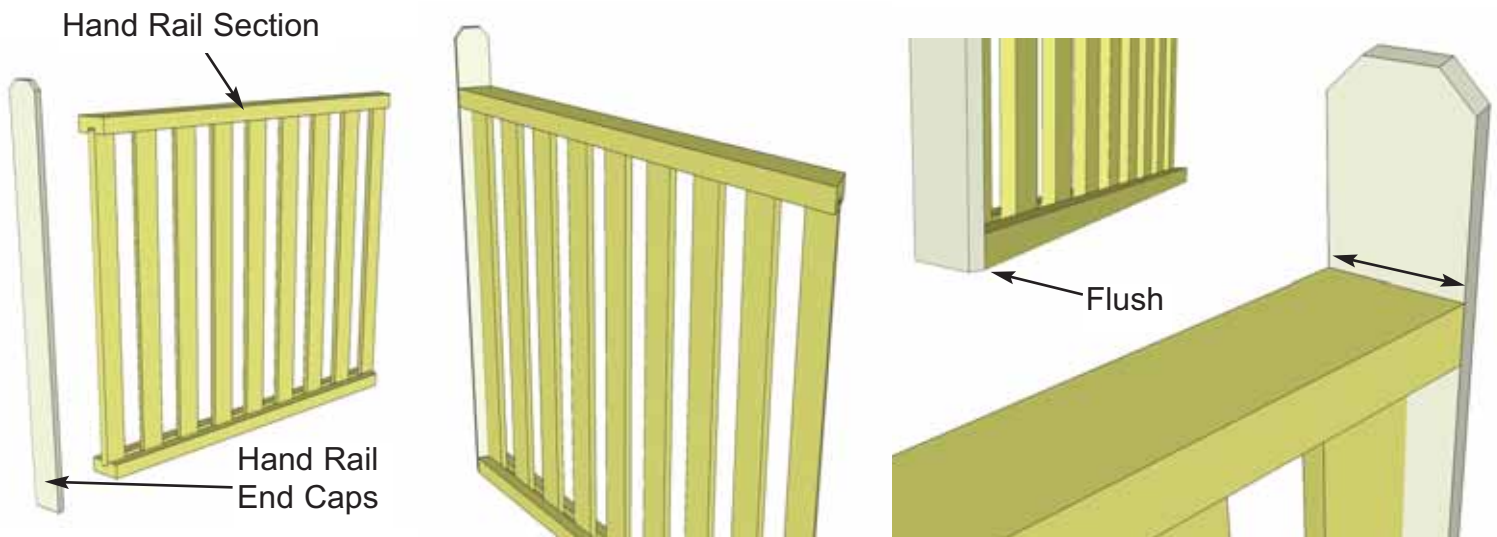

45. To complete Handrail Sections, locate Hand Rails and Hand Rail End Caps. Position End Cap flush with Bottom Rail. Evenly space End Caps from side to side with both Top and Bottom Rails.



46. When correctly positioned, attach with 4 - 2" screws. Complete all Handrail Sections now. **Important-** Drill 1/8" Pilot Holes in End Caps to prevent splitting. Be sure to drill into Handrails.

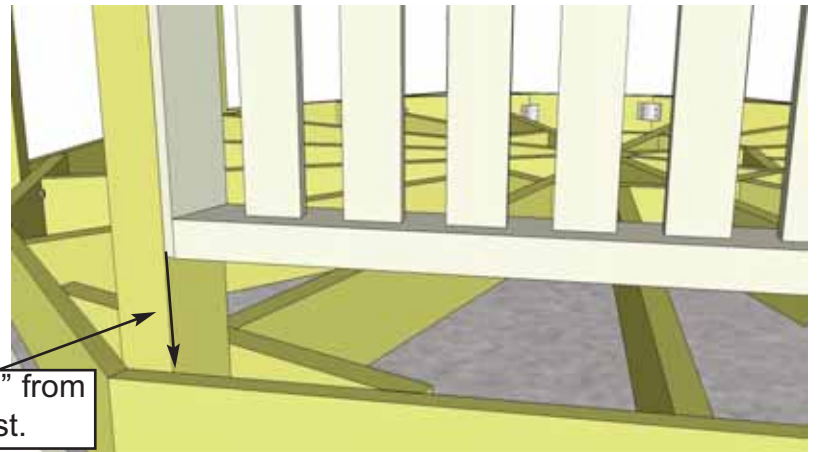
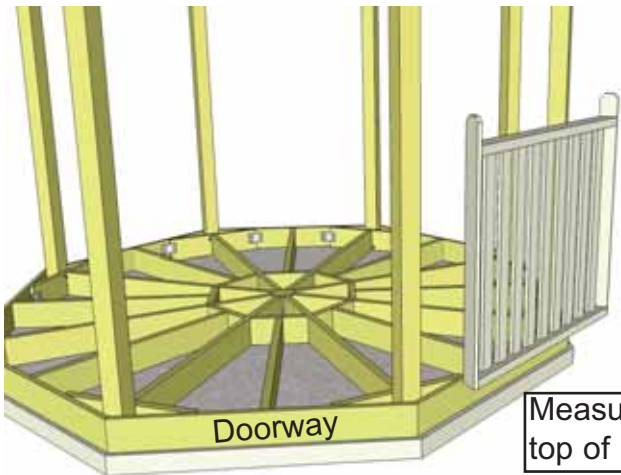

47. Starting on right side of Doorway, position first Handrail Section between Posts. Position bottom of Handrail Section 4 1/2" above top of the Rim Joist. Position End Cap of Handrail Section equally from front to rear or best fit on Post. **Use the Plywood Post Spacing Template to determine height of Handrail.**

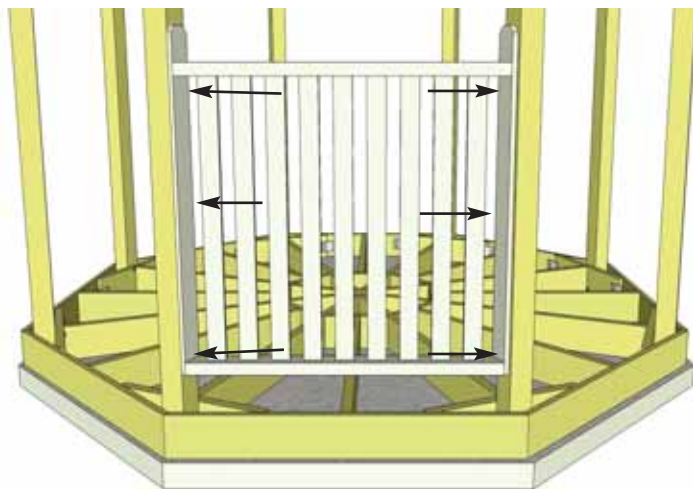

48. With Handrail Section positioned correctly, screw End Cap to Posts with 3 - 2" screws per side. Position and secure a second Handrail Section between Posts moving Counter Clockwise direction. Once again, use 3 - 2" screws per side to secure.



49. Complete remaining Handrail Sections positioning and securing as per **Step 48**.

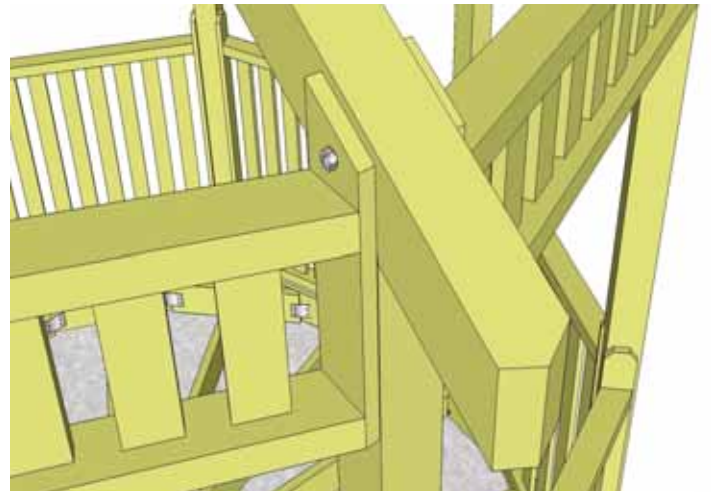
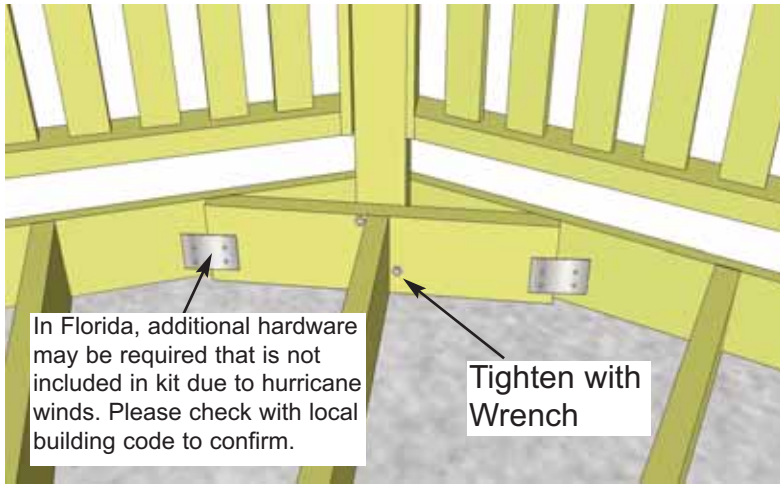

50. With both the Upper Baluster and Handrail Sections complete, go back and tighten all the Carriage Bolts in the "T" Post Mount Plate and Rafter with a Wrench. Be careful not to over tighten bolts. Complete one side and then the opposite side. This will create an equal tightening of all the components.

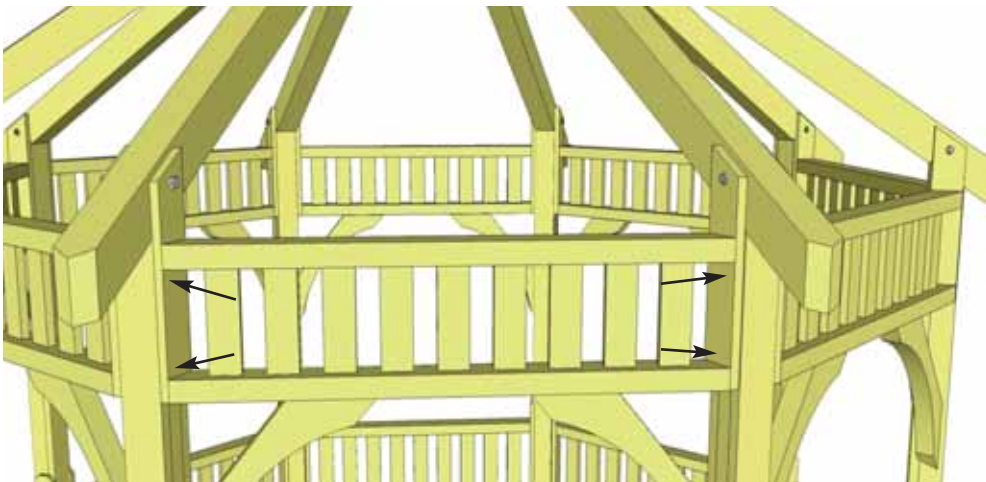

51. To completely secure Rafter / Post and Upper Rail Sections, place 2 - 2" screws from the side framing of Upper Rail Section into Posts.

D. Floor Section

Important- If you have purchased a Screen Kit Option, Floor Screening must be installed prior to Step 51 (Floor Panel installation), please refer to Screen Kit Option Assembly Manual for instructions.

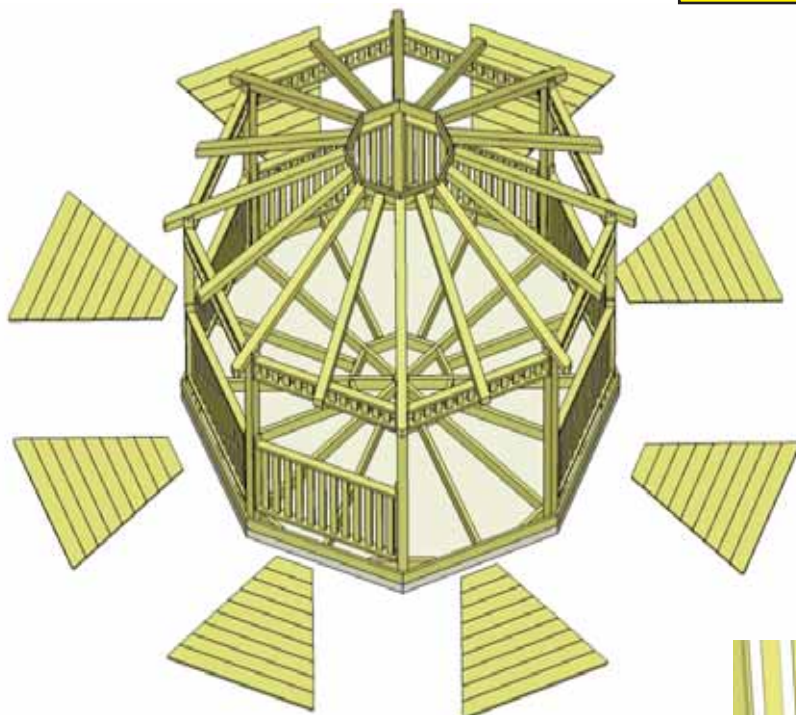

52. Locate and place 8 pie-shaped **Floor Panels** around the perimeter of the gazebo.

53. Lift up and lay your first Panelized Floor Panel on Floor Joists. Position Panelized Floor Panel so it sits equally on Floor Joists.

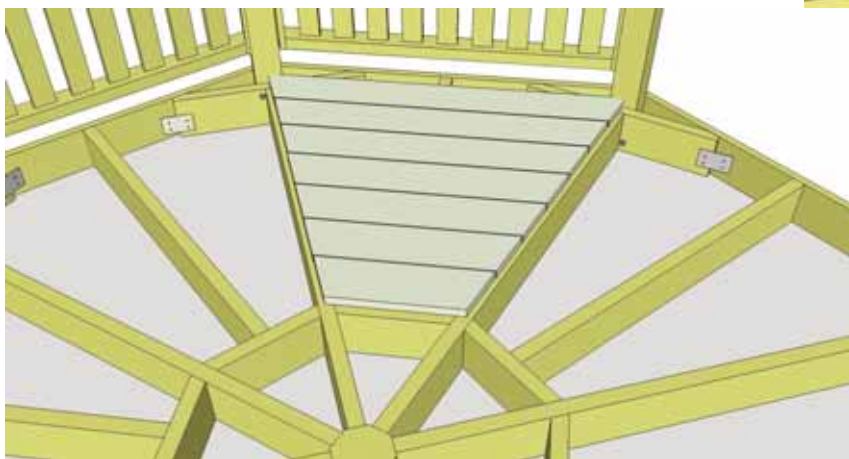
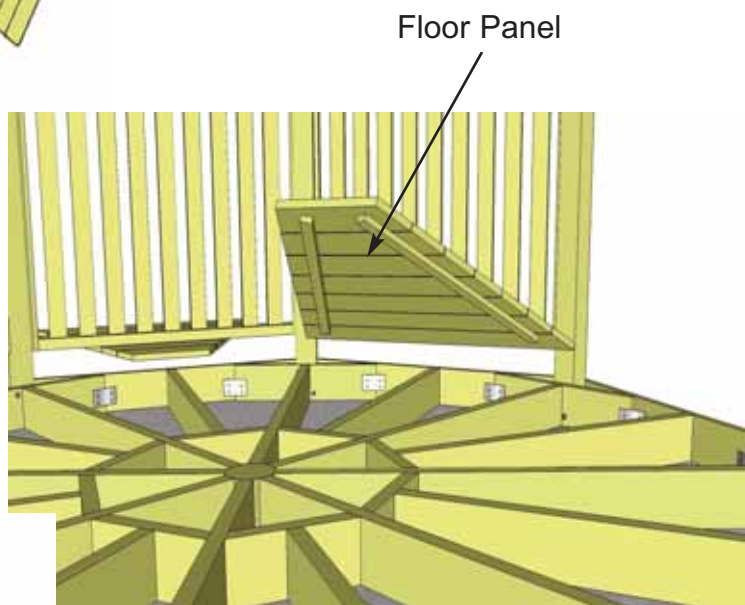

Important- Do not secure Floor Panel to Floor Joists until all Floor Boards are in place and properly positioned. See **Step 56** to secure Floor Panels completely.

Floor Joist

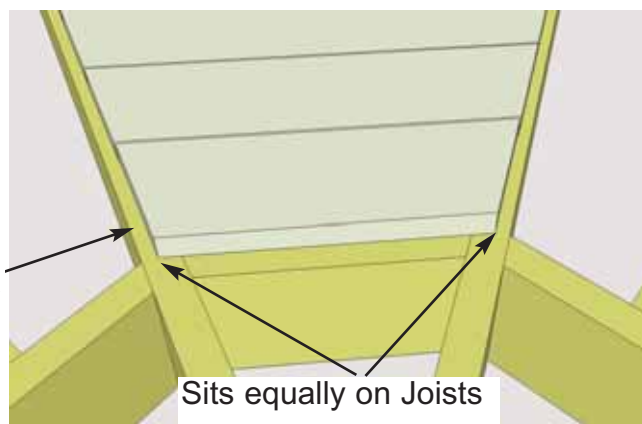

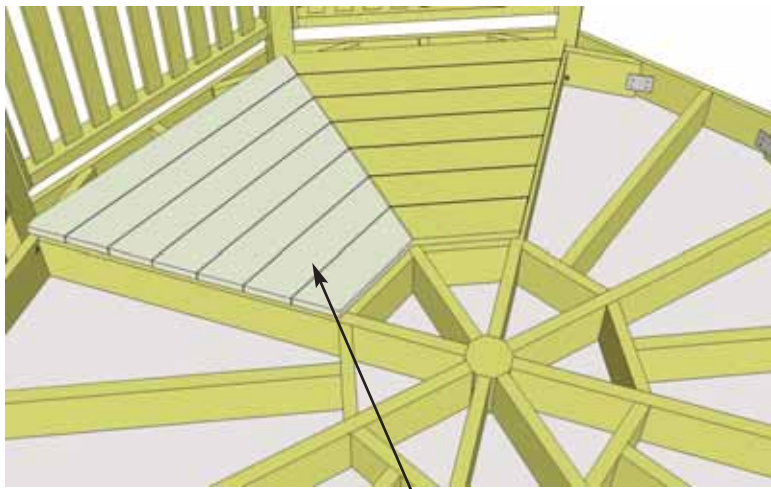

2nd Floor Panel

54. Place and position 2nd Floor Panel on Floor Joists. Position as per **Step 53.**

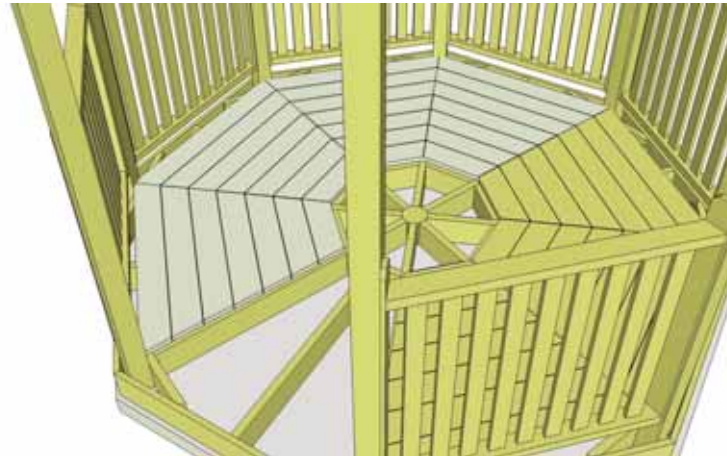

55. Place and position remaining Floor Panels around the Floor Joists. Position as per **Step 53.**

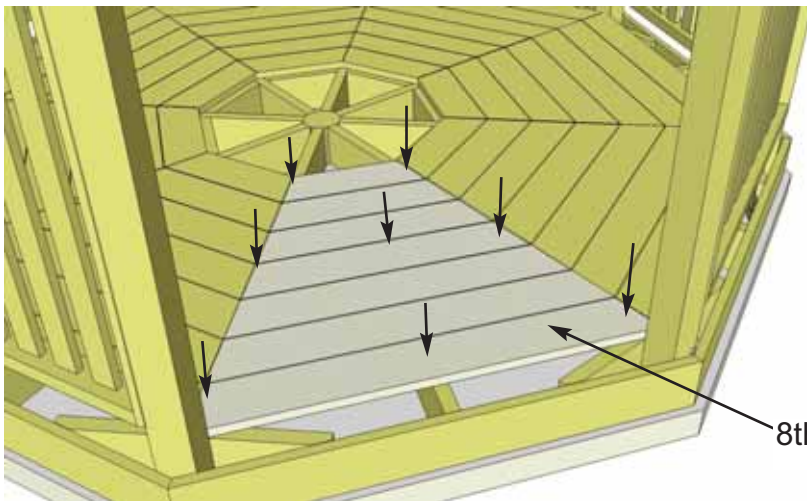

8th Floor Panel.

56. With all panels evenly spaced and in their correct position, secure each panel down to floor joists with 8 - 2" screws per panel.

Note, drill 1/8" pilot holes to prevent splitting.

2nd to Last Deck Board

57. Place the **2nd to Last Deck Board** on Floor Joists and position between joists. (14 1/8" long)

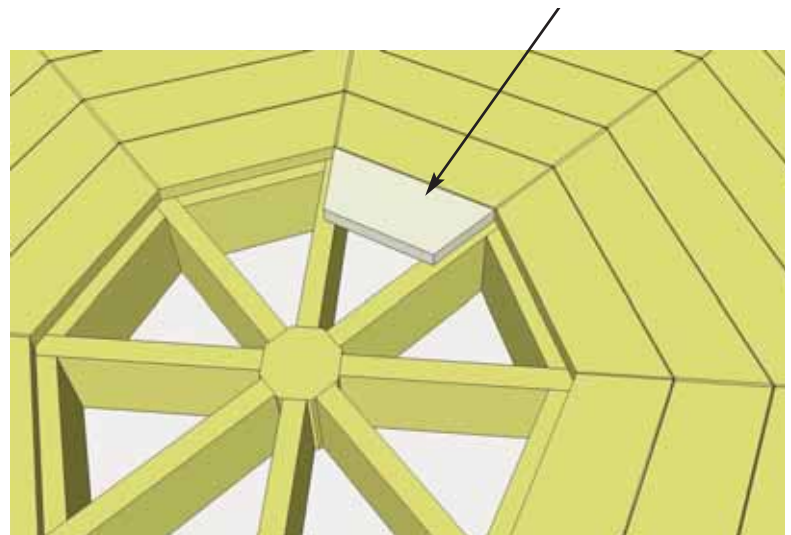

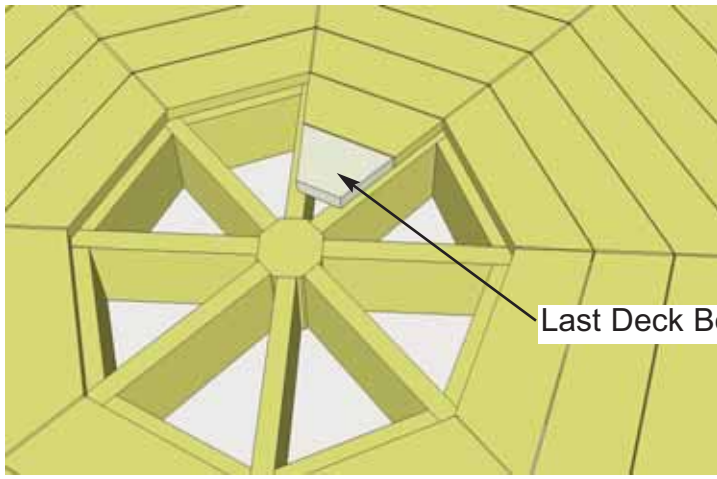

58. Place **Last Deck Board** on Floor Joists and position between joists. (9 1/2" long)
Do not secure until all remaining Deck Boards are positioned.

59. Position all remaining Deck Boards around the center of the floor. Position so they fit evenly around the floor.

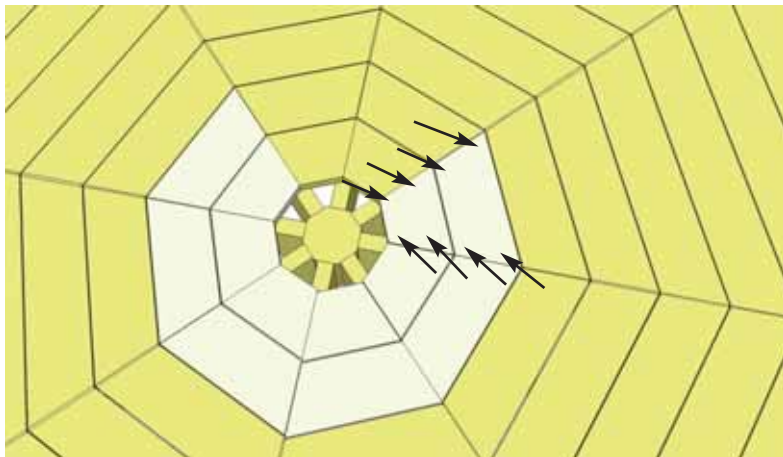
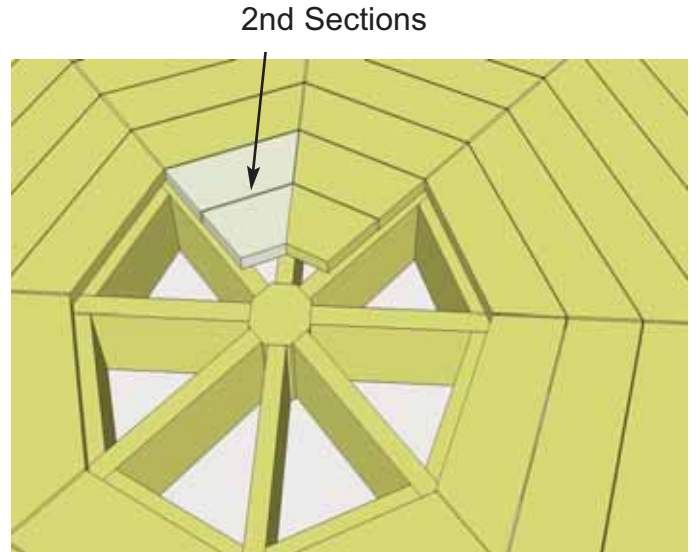

60. Secure each Deck Board with 4 - 2" screws per piece (2 per side).

Note, drill pilot holes to prevent splitting.

61. Place the **Center Deck Piece** into place and secure with 4 - 2" screws.

Note, drill pilot holes to prevent splitting.

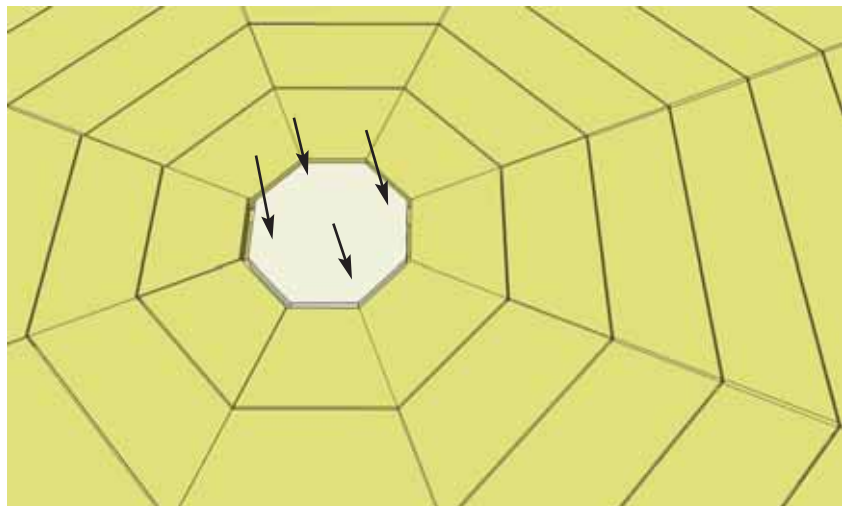

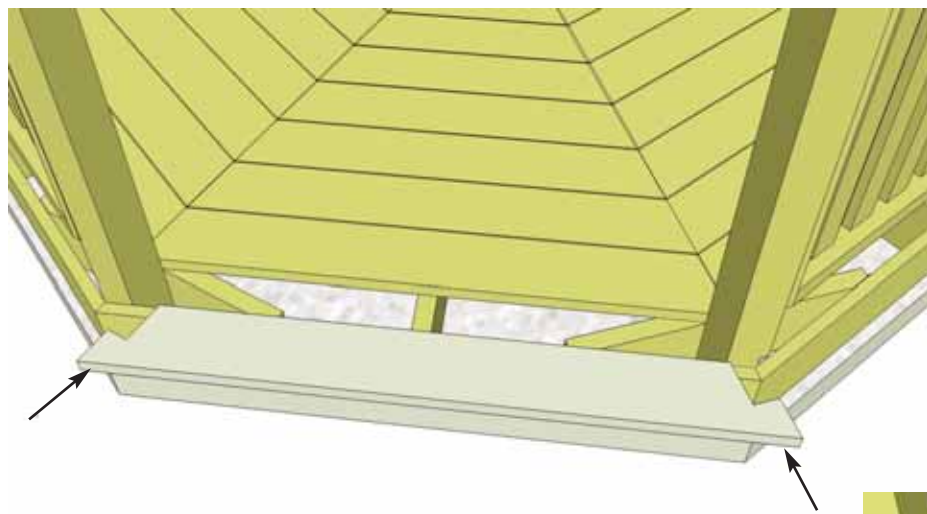

62. Locate a **Perimeter Deck Board - Notched** for Posts and place so it rests on the Rim Joist and against Posts.

Expert Advise - Position all Perimeter Deck Boards around gazebo as shown in **Step 65** to even gaps between boards prior to attaching.

63. With Perimeter Deck Board positioned correctly, secure board with 5 - 2" stainless steel screws.

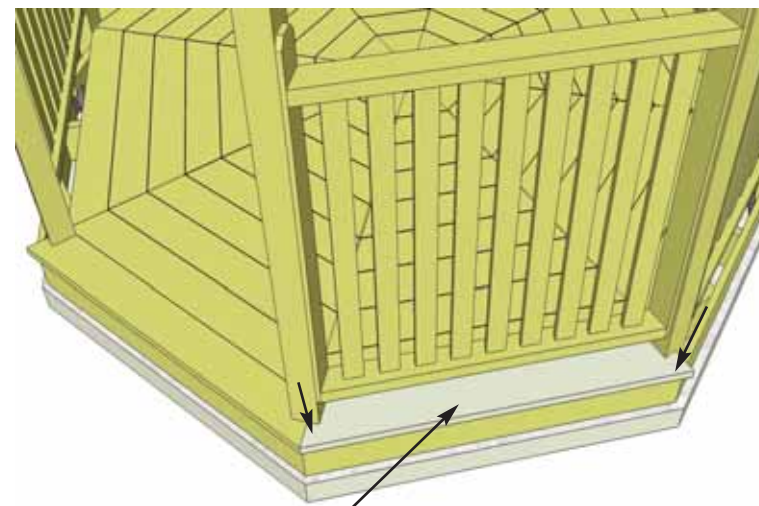
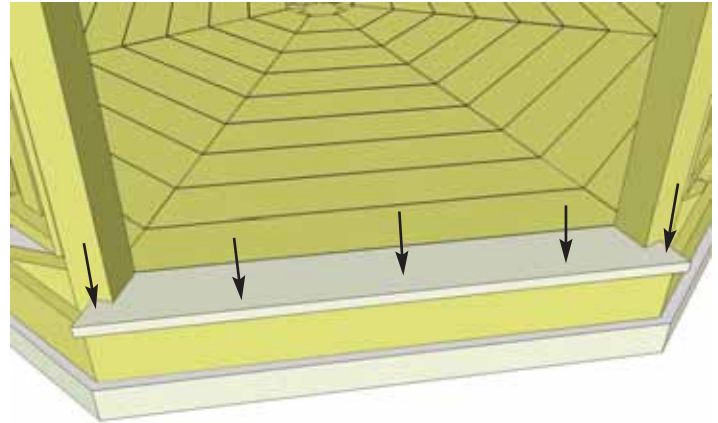

64. Place 2nd Perimeter Deck Board into place and secure with 5 - 2" stainless steel screws.

2nd Perimeter Deck Board

65. Complete positioning and securing remaining Perimeter Deck Boards as per **Step 63**.



66. Starting at next to the entrance, lift and position 1st **Left Side Roof Panel** up so it sits equally between Corner and Mid Rafter. The top of the panel will sit in the dado of the Skybox frame.

E. Roof Section

Panel sits in Dado of Skybox.

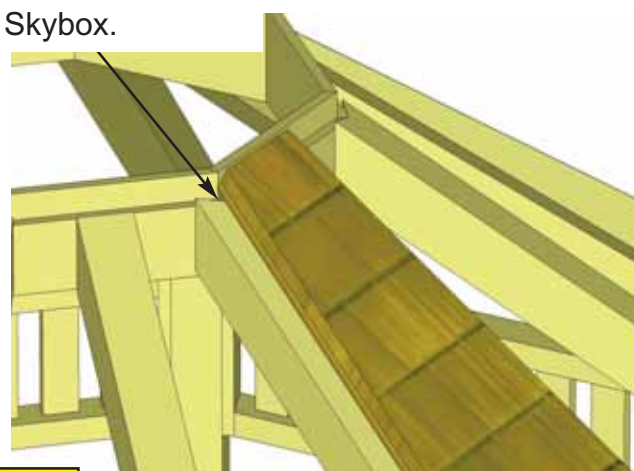
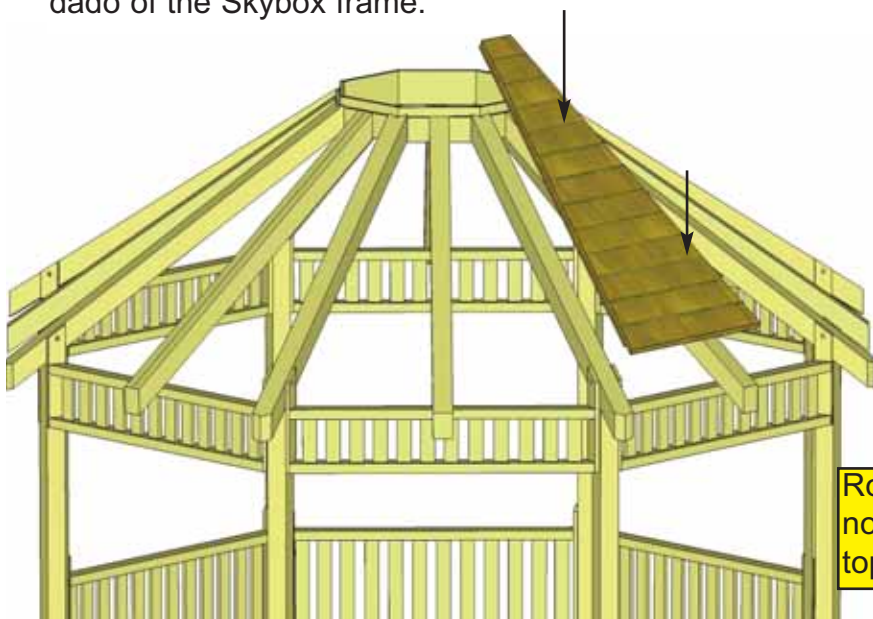

Roof Panel not to exceed top of Skybox

Note, Screw locations.

Position Roof Panel Section equally on Rafter.

Important: After all Roof Panel Sections have been positioned and partially secured in **Step 77**, slight adjustments to some panels may be necessary to achieve best fit.

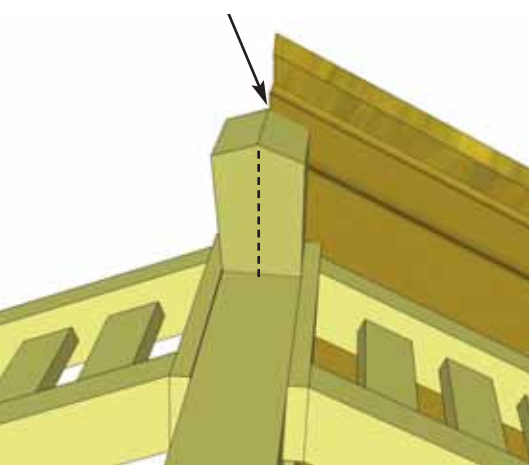
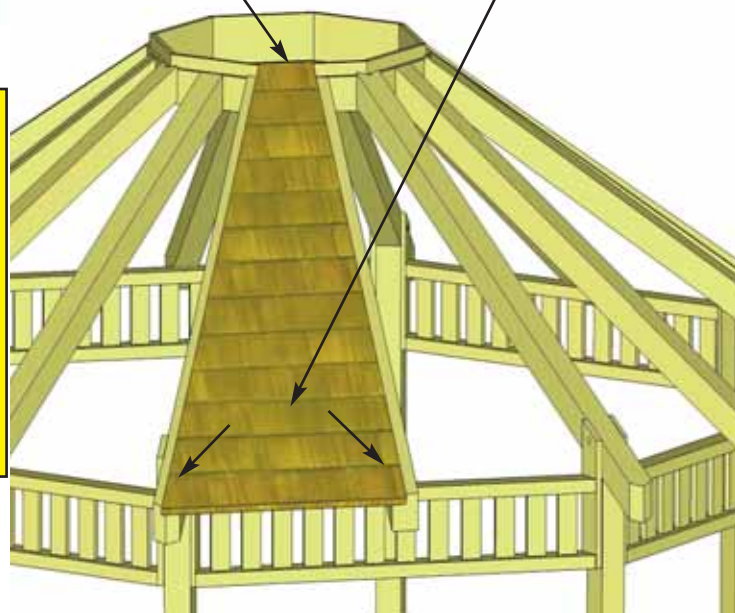

67. With Left Roof Panel positioned equally on rafters, secure panel to Corner Rafter and Mid Rafter on bottom row of shingles **Only** with 1 - 3" screw per side. Screw from shingles into rafters.

68. Lift and position a **Right Side Roof Panel** and place so equally centered on Mid and Corner Rafters.

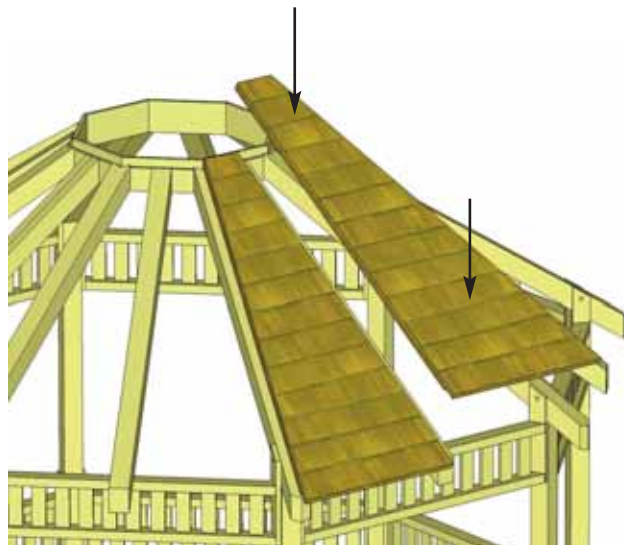

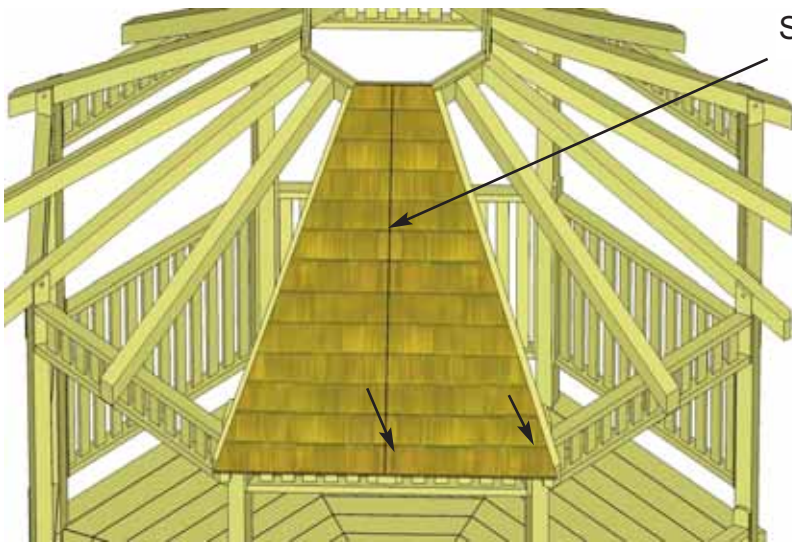

69. Position and attach as per **Step 66-67**. Use 2 - 3" screws in Corner and Mid Rafter through bottom shingle.



70. Lift and place 2nd Left Side Roof Panel in adjacent pie shape section.

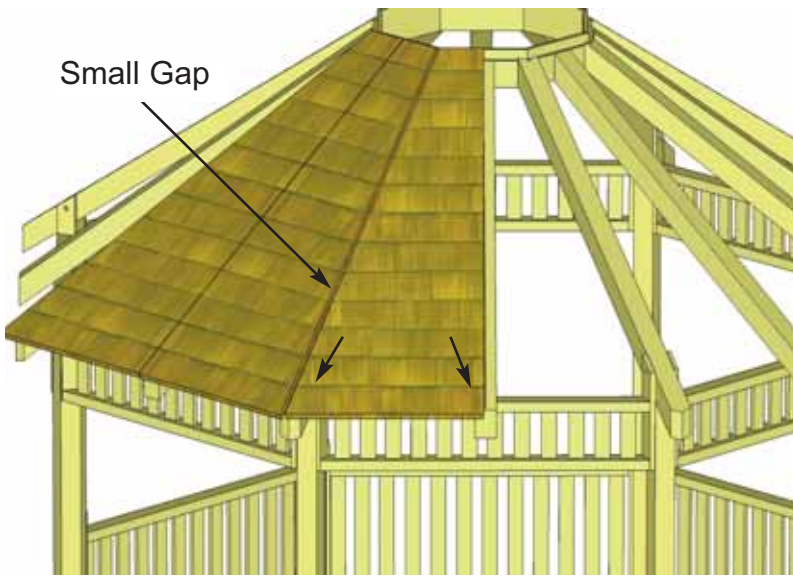

71. Position and attach as per **Step 66 - 67**. Use 2 - 3" screws in Corner Rafter and Mid Rafter through bottom row of shingles. Lift and position 2nd Right Side Roof Panel on Center and Corner Rafter.

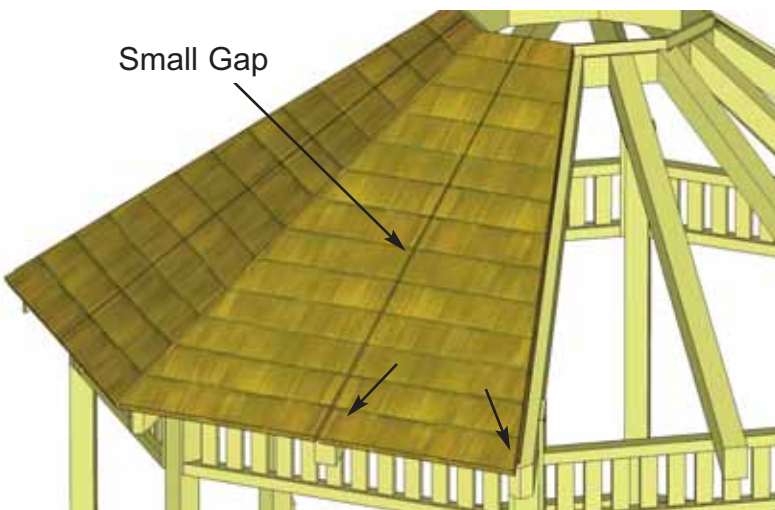
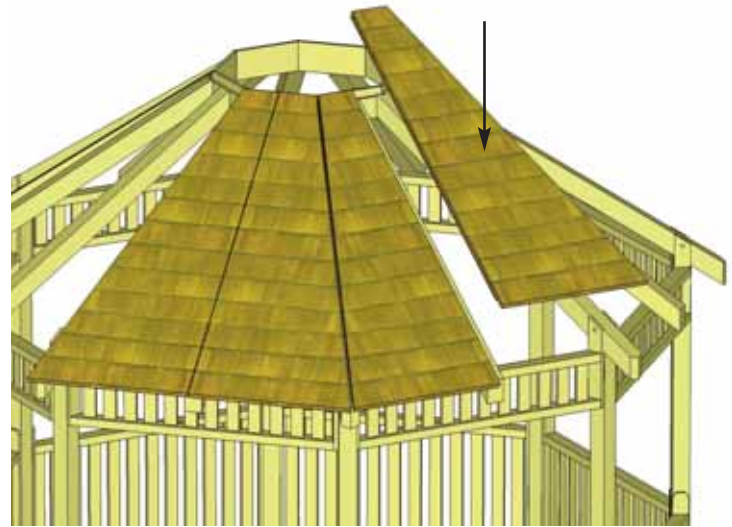

72. Position and attach as per **Step 66-67**. Use 2 - 3" screws in Corner and Mid Rafter through bottom row of shingles.

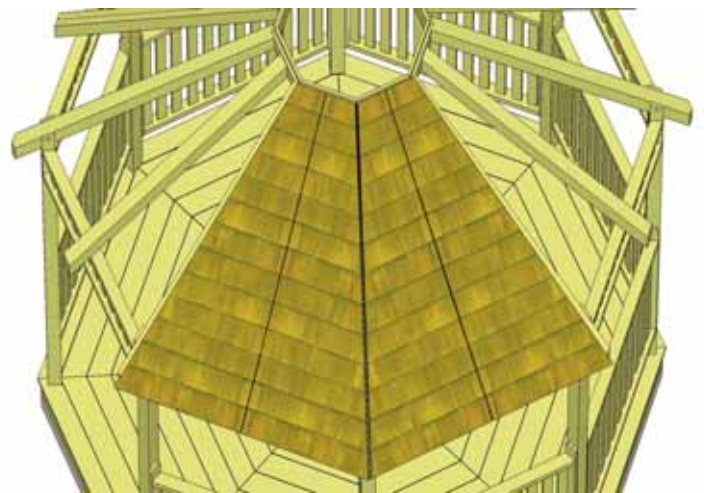

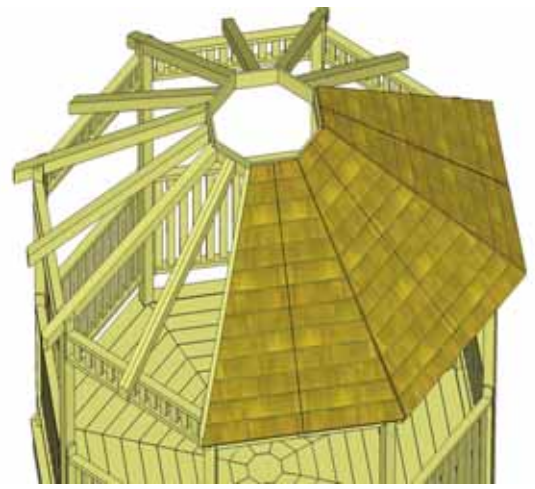
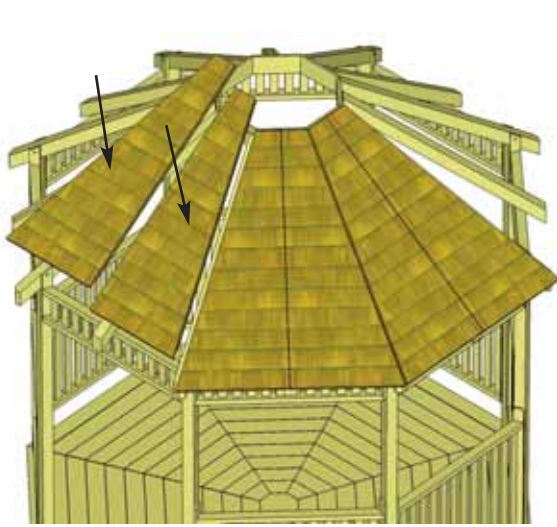

73. Complete next set of Roof Panels over entrance way. Since this will be a focal point of the gazebo, be sure to install panels carefully. Follow **Steps 66-67** when positioning and attaching panels.

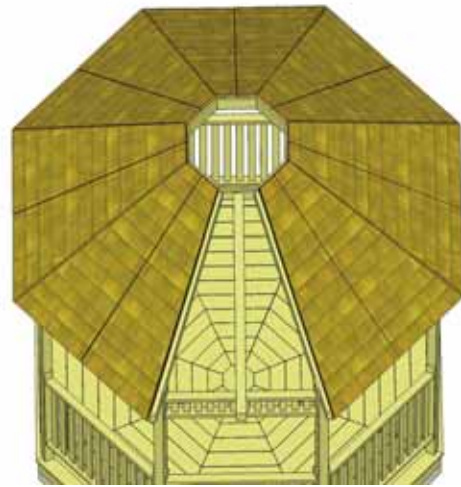
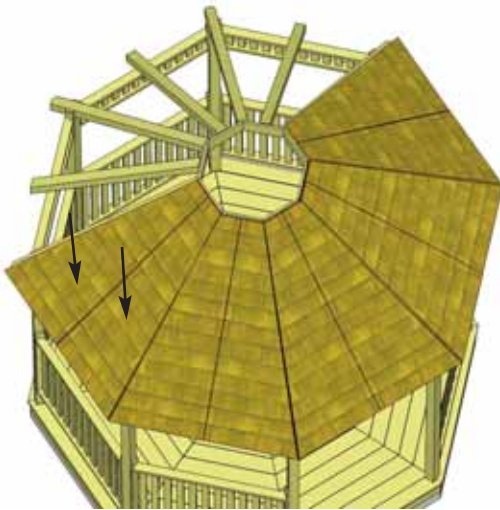

74. Continue positioning and securing each set of Roof Panels around the Gazebo. Leave the last set of Panels towards the rear of the gazebo.

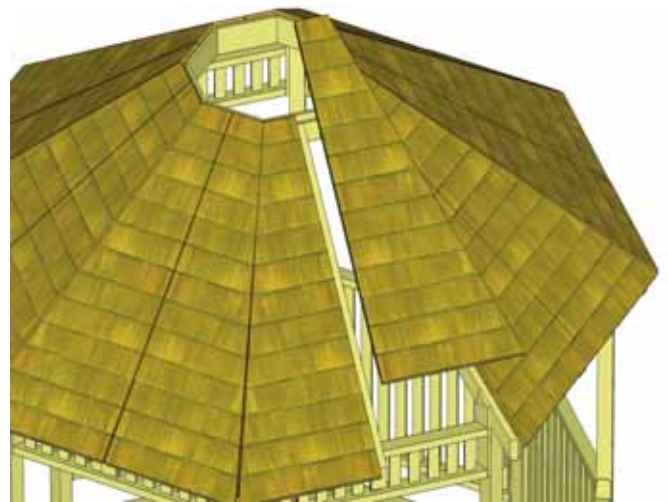

75. Complete remaining set of Roof Panels. Position and secure as per **Step 66-67**.

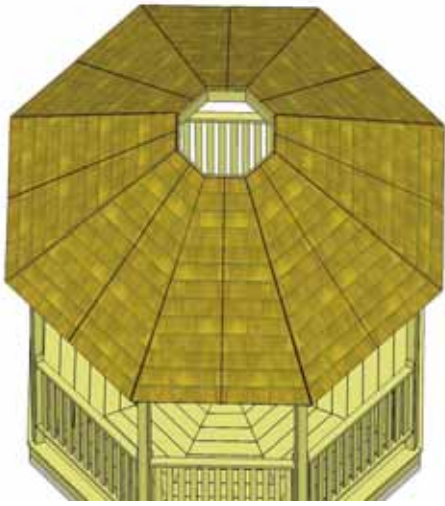

76. After all Roof Panel Sections have been positioned and partially secured, slight adjustments to some panels may be necessary to achieve best fit. Remove previously secured bottom screws installed in Roof Panels and re-position if necessary.

Important - Any gaps between Roof Panels will be covered later by **Roof Ridge Caps** and **Filler Shingles**.

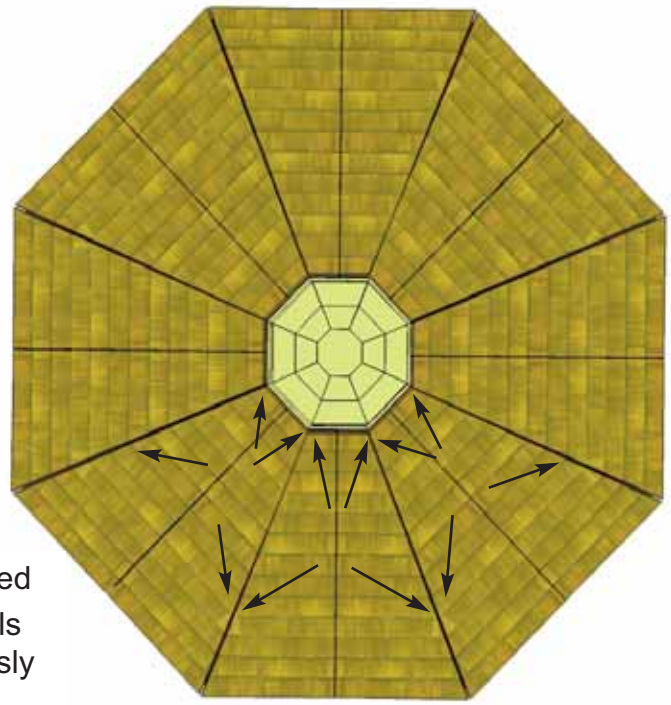

77. Important - When satisfied with Roof Panel positioning, further secure panels to gazebo. Screw through Roof Panels into Corner Rafters **ONLY** at mid and top locations with 3" screws. See illustration above for screw pattern. Roof will be secured to Mid Rafter while securing Filler Shingles later. **DO NOT SECURE ROOF TO MID RAFTERS AT THIS TIME.**

Reach through Skybox while securing Roof Panels at the top.

78. Locate 64 7/8" long **Facia Boards**. Facia Boards are angle cut on each end. Place 1 board over the entrance way underneath the roof and against the rafter ends.



Facia Board should be positioned so it is flush underneath the roof panel and angle cut end of board should sit halfway on Rafter end.

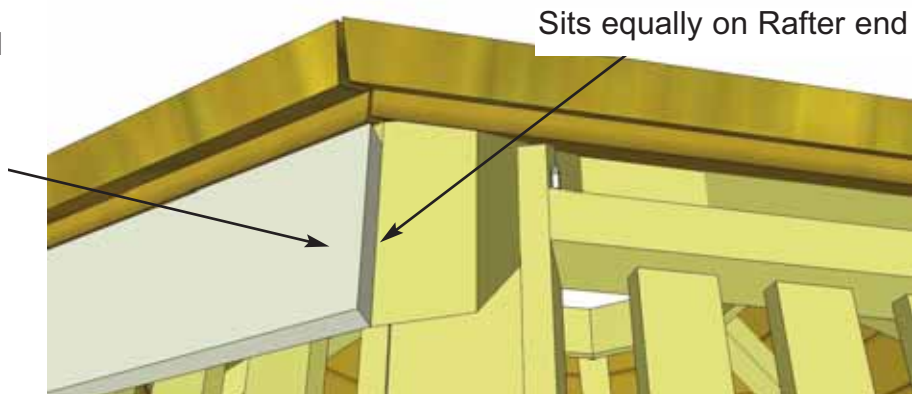

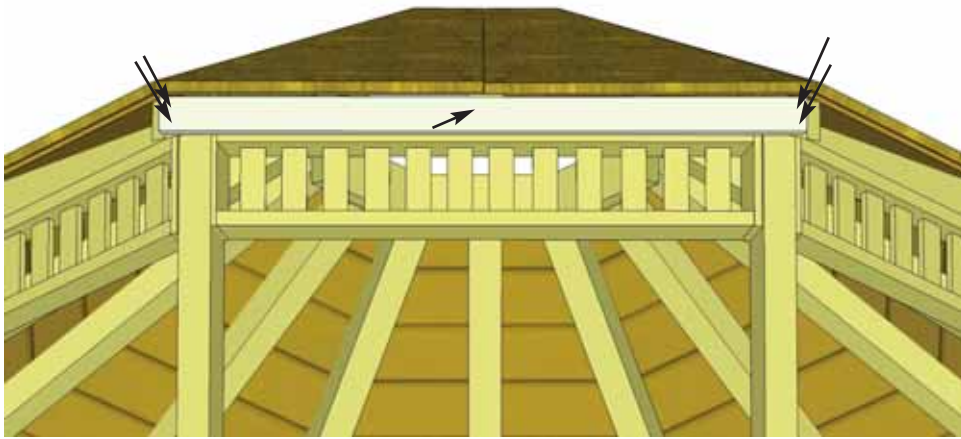

79. With the Facia Board positioned correctly on Rafter ends, secure with 4 - 2" screws per side. Drill 1/8" pilot holes to prevent splitting. Note- Align screws so Facia Detail Plate will cover. See **Step 128** for details.

At Mid Rafter, secure Facia with 1 - 2" stainless screw as shown to the left.

80. Position and secure the 2nd Facia Board to end of Rafters as per **Steps 78-79**.

Important - it is normal for gaps to occur between Facia Boards. Later, **Corner Facia Detail Plates** will be added to cover any gaps.

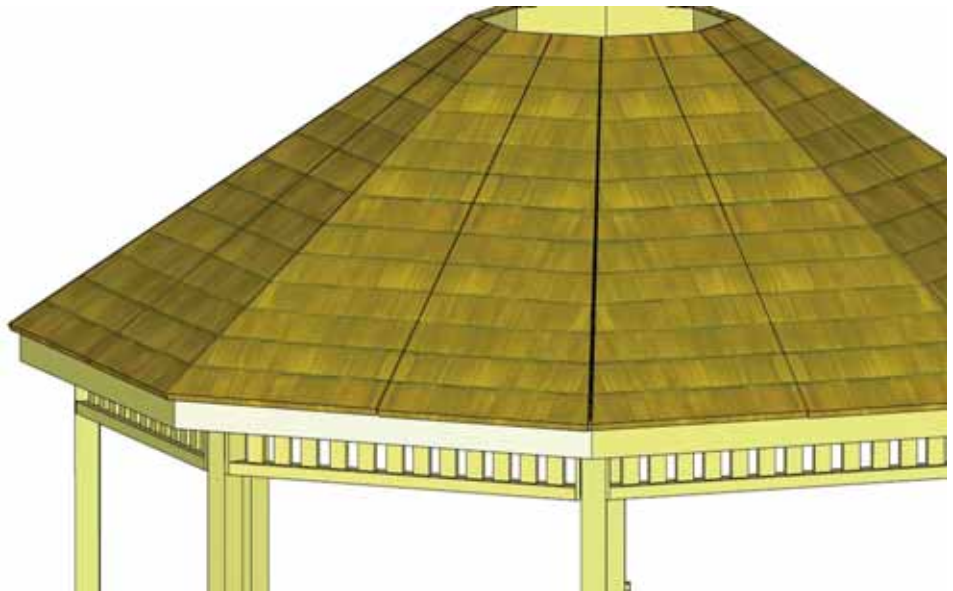
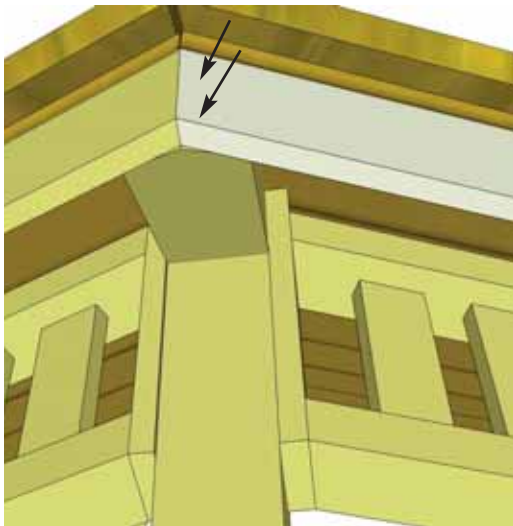
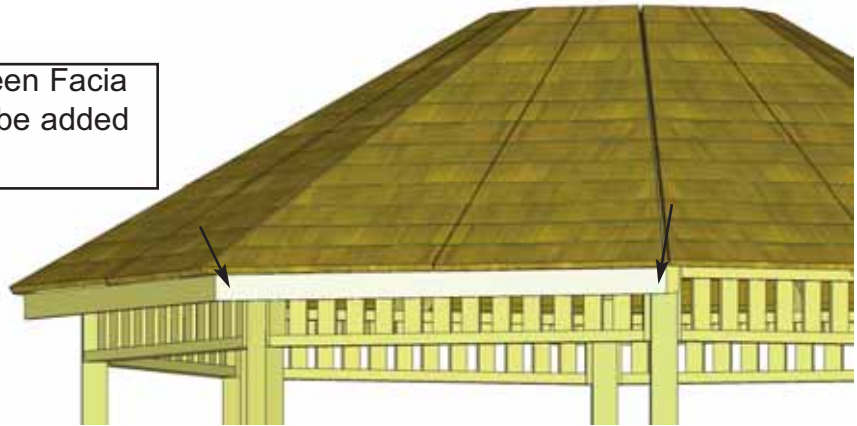

81. Complete positioning and securing Facia Boards to Rafter ends. Use the same pattern as for the Roof Panel Sections. Secure as per **Step 79**.

Important - it is normal for gaps to occur between Facia Boards. Later, **Corner Facia Detail Plates** will be added to cover any gaps.

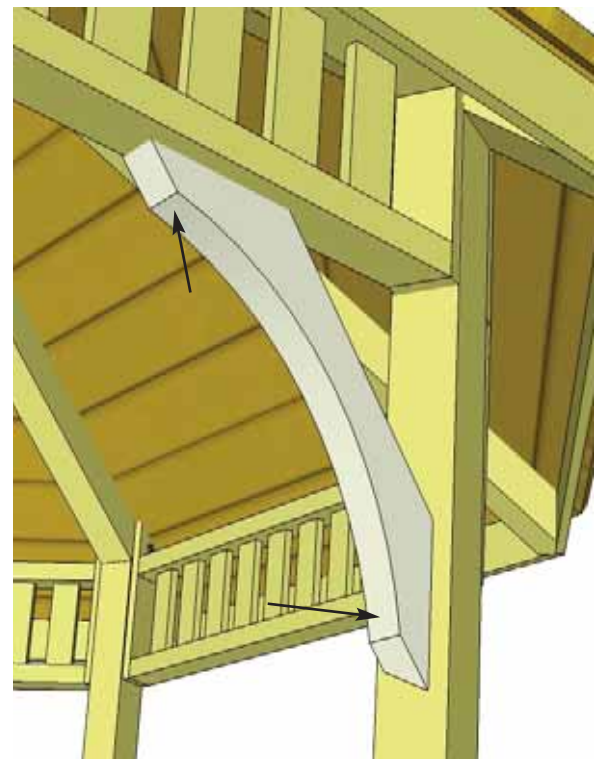
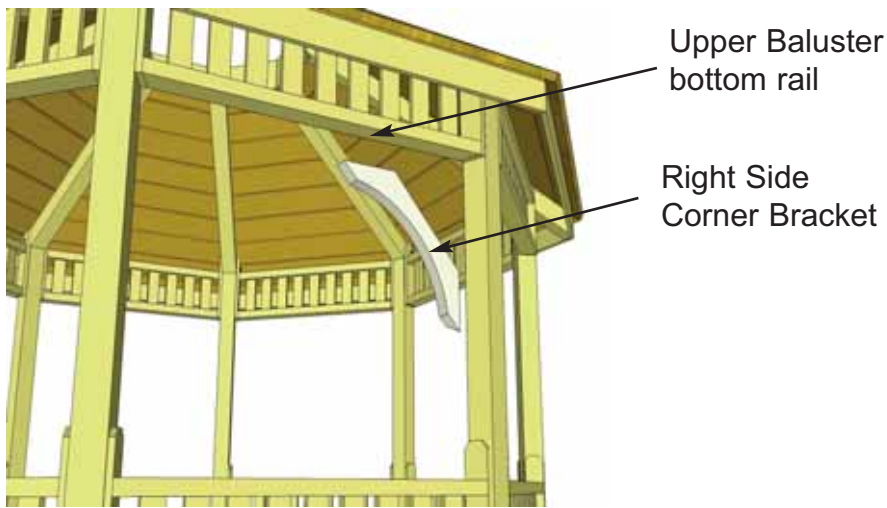

82. Locate 16 **Corner Brackets** (8 Left / 8 Right Side). Place into position on Post and on the Upper Baluster Section bottom rail. With Bracket Centered on Post and Upper Baluster Section, drill pilot hole in Bracket to prevent splitting before securing with 2 - 3" screws.

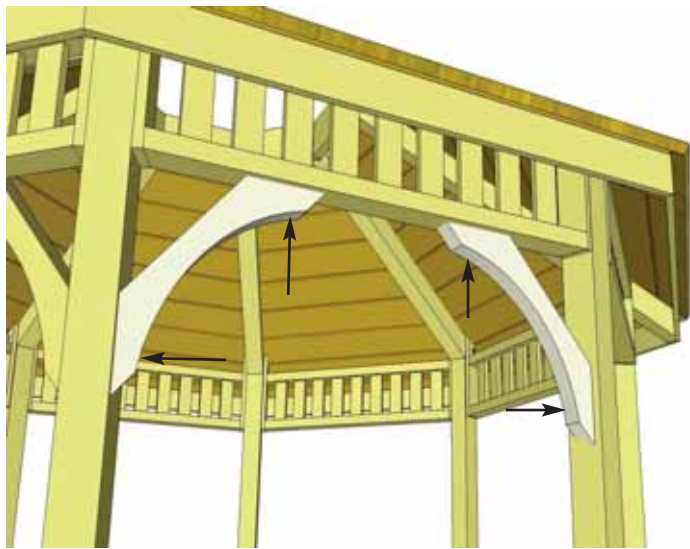

83. Complete both left and right Corner Bracket attachments making sure to position and drill pilot holes prior to securing with 3" screws.

84. Complete all Corner Bracket attachments.

Important:
 If installing an Outdoor Living Today Optional Screen Kit. Do not install Doorway Corner Brackets.



F. Cupola Section

Important- Pre-drilling 1/8" pilot holes in Cupola components will help prevent wood from splitting. We highly recommend this.

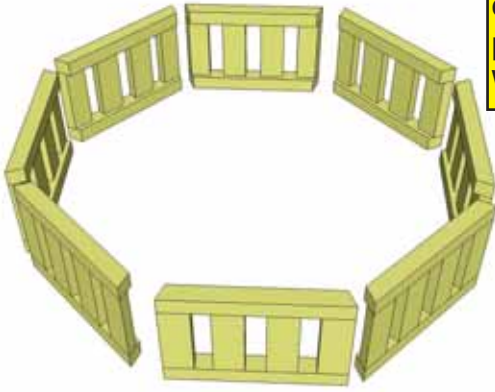

85. Locate 8 Side Rail Cupola Sections and place in octagon shape as shown above.

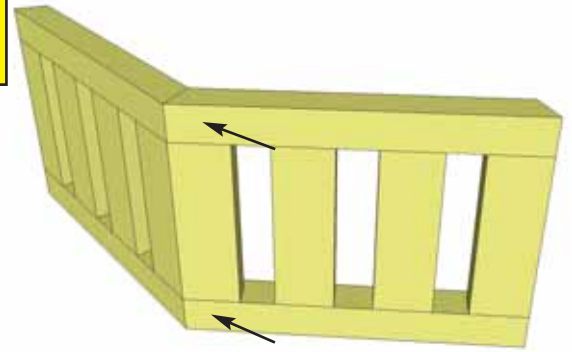

86. Screw each section together with 2 - 2" screws.

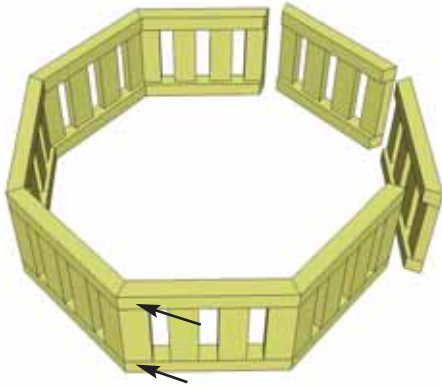

87. Continue attaching sections together.

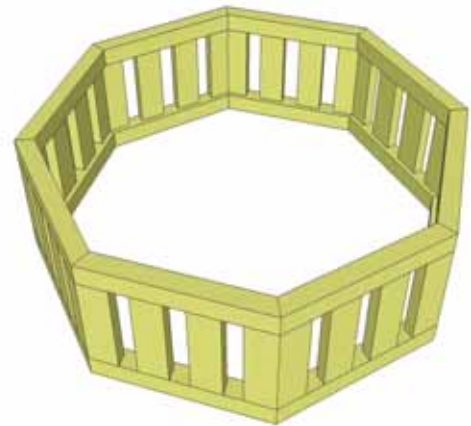

88. Complete Side Rail Section and move to the side

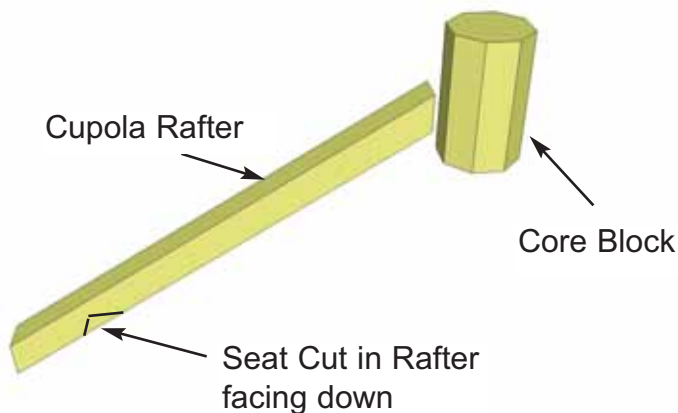

89. Locate Cupola Rafters and Core Block. Place one Rafter against Core Block as shown above.

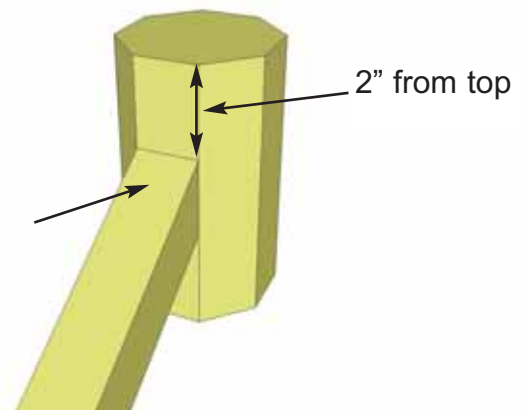

90. Angle screw Rafter into Core Block 2" from top with 3" screw.
Important - Drill 1/8" Pilot Hole in Rafter end to prevent splitting.

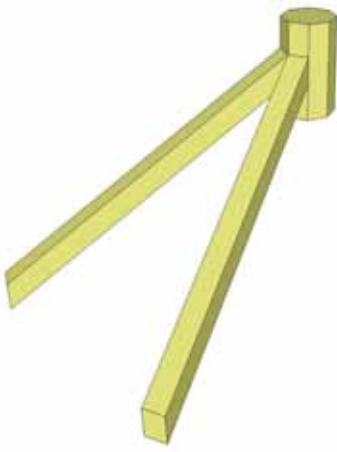

91. Continue attaching Rafters to Core Block securing with 3" screws 2" from the top.

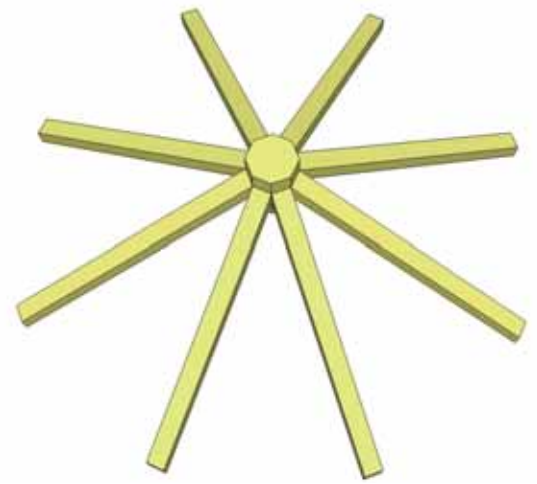

92. Complete all Rafter / Core Block attachments.

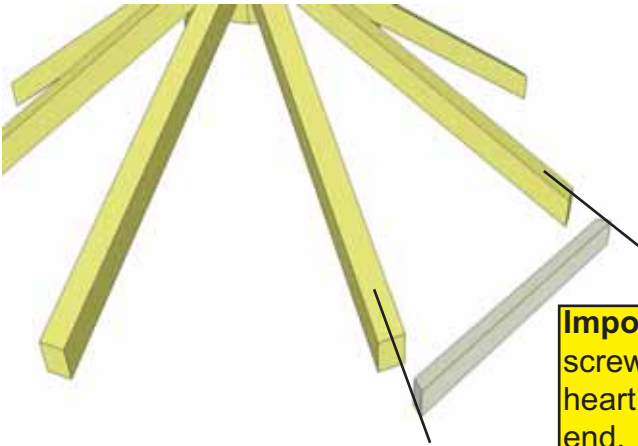

Important- angle screw up into the heart of Rafter end.

93. Locate 8 Cupola Facia Pieces and place against Rafter ends.

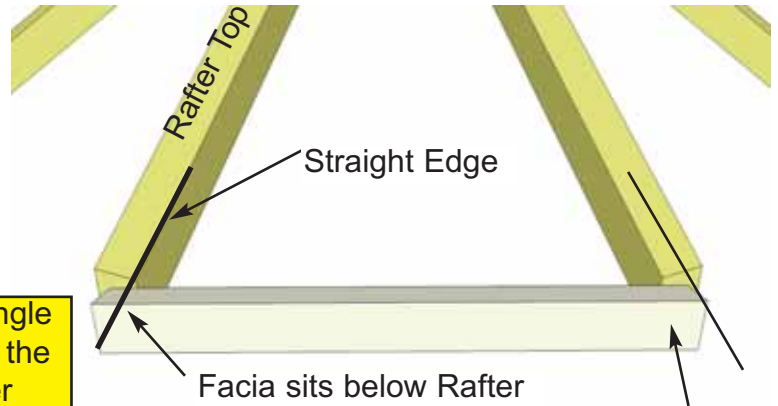

94. Position Rafter so it sits equally on both Rafter ends. Also, use a straight edge to make sure Rafter sits approx. 3/8" below rafter top. Attach Facia to Rafter end with 2 - 2" screws per Facia.

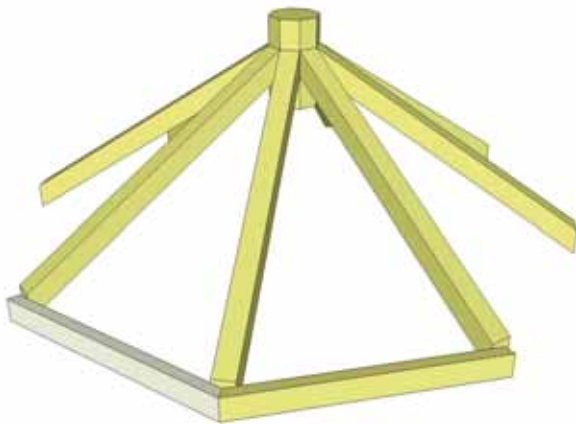

95. Position and secure second Facia Piece.

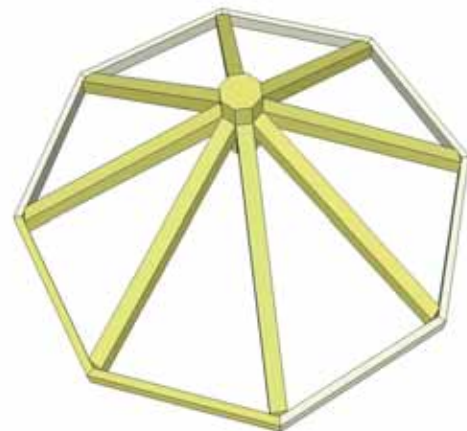

96. Place and secure all Facia Pieces as per **Step 94**.

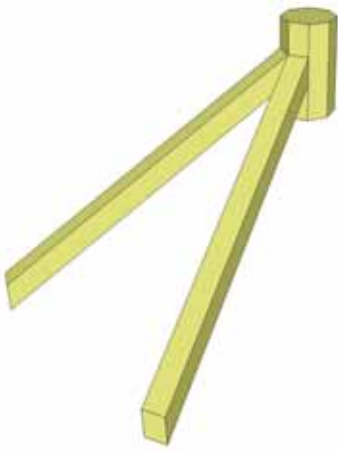

91. Continue attaching Rafters to Core Block securing with 3" screws 2" from the top.

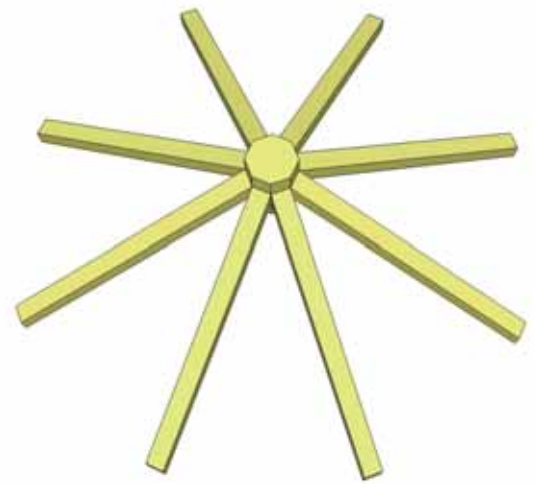

92. Complete all Rafter / Core Block attachments.

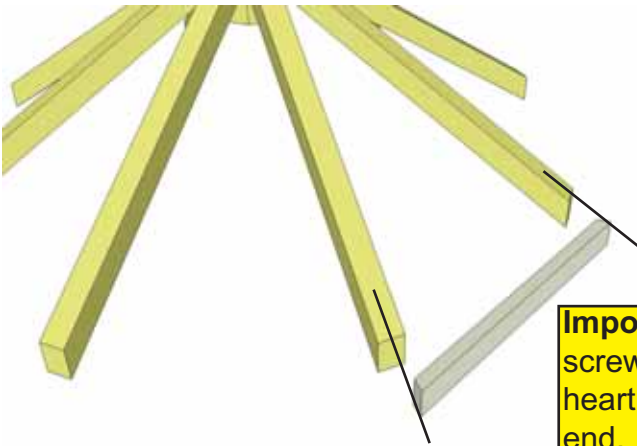

93. Locate 8 Cupola Fascia Pieces and place against Rafter ends.

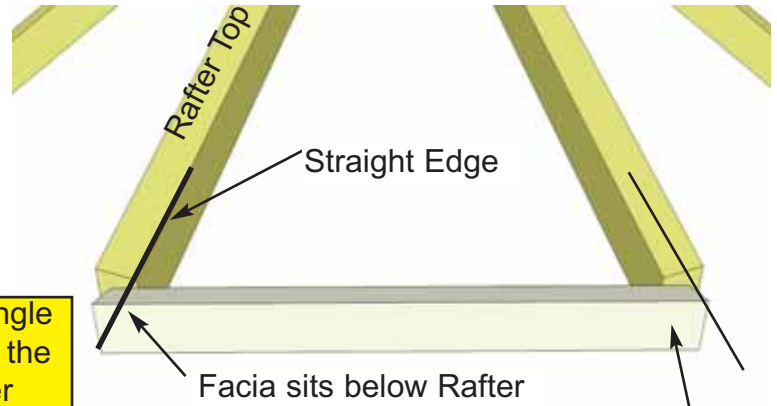

94. Position Rafter so it sits equally on both Rafter ends. Also, use a straight edge to make sure Rafter sits approx. 3/8" below rafter top. Attach Fascia to Rafter end with 2 - 2" screws per Fascia.

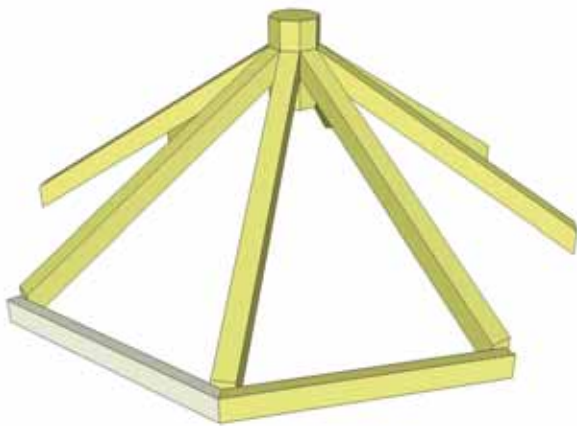

95. Position and secure second Fascia Piece.

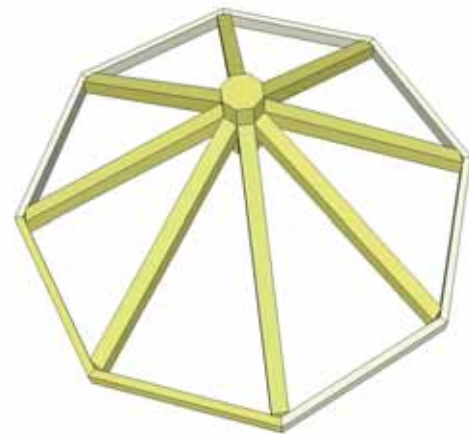

96. Place and secure all Fascia Pieces as per **Step 94**.

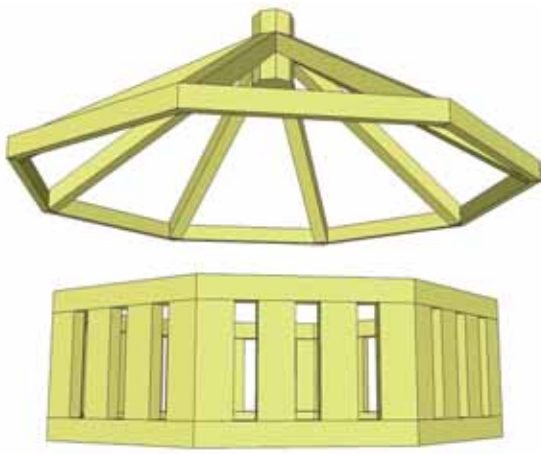

97. Place completed Rafter/Facia Section on Side Rail Section.

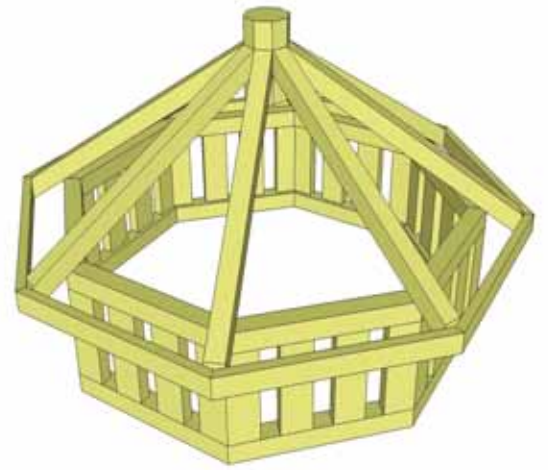

98. Line up Rafter equally on each corner of the Side Rail Section.

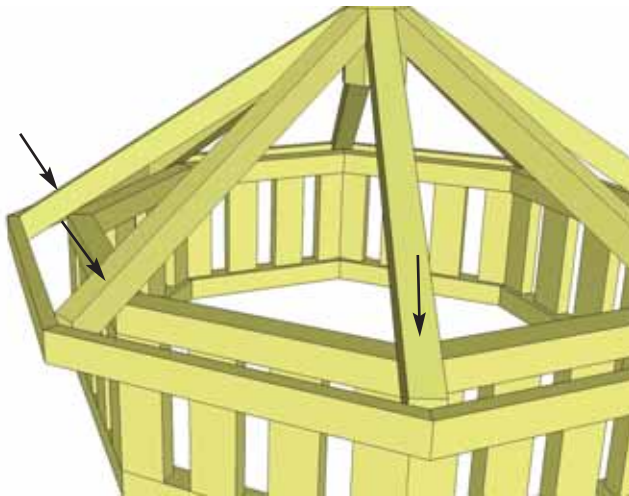

99. With Rafter/Facia Section positioned equally on Side Rail Section, attach together by screwing with 1 - 2" screw per Rafter.

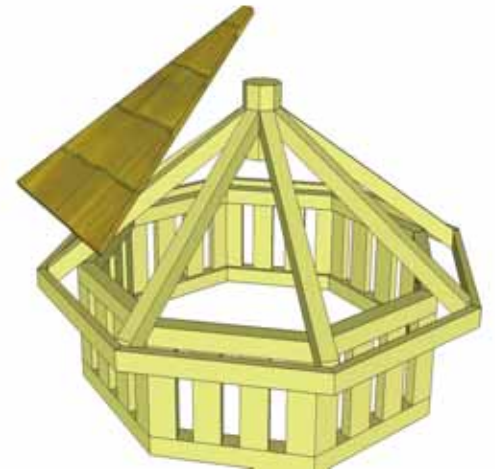

100. Locate and place 1st Cupola Roof Panel on Rafters.

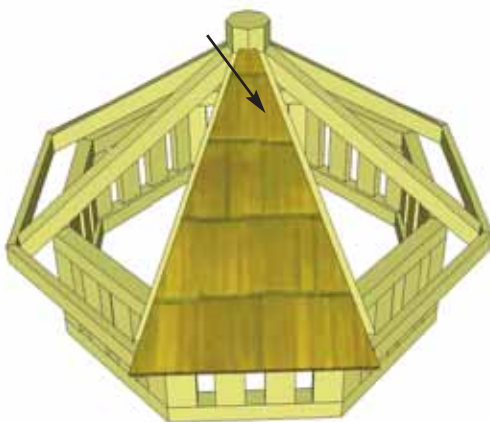

101. Place Roof Panel centered equally on Rafters and against Core Block. Attach panel to rafter with 1 - 2" screw at top. Later In **Step 105**, you will completely secure Roof Panels.

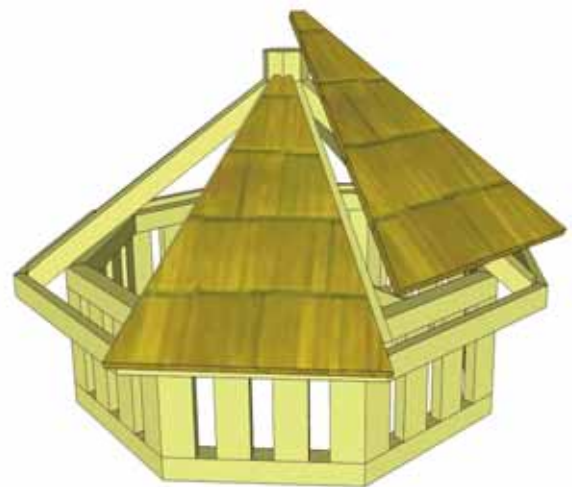

102. Place 2nd Cupola Roof Panel in place.



103. Position and attach 2nd Cupola Roof Panel as per **Step 101**.

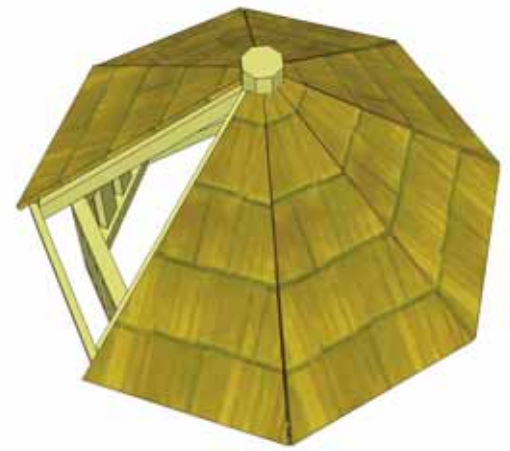

104. Continue to position and attach Cupola Roof Panels. Gaps may appear between Roof Panels but will be covered later by Roof Ridge Caps.

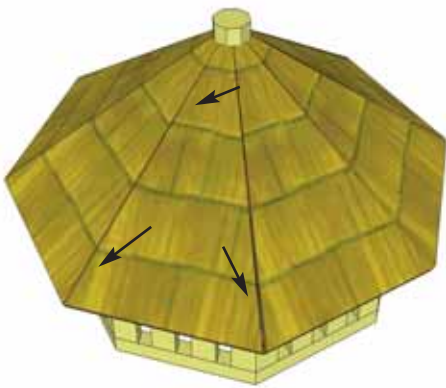

105. Position 8th Cupola Roof Panel in place and make any necessary adjustments to achieve best fit. Secure with 3 additional 2" screws per panel as per **Step 101**.

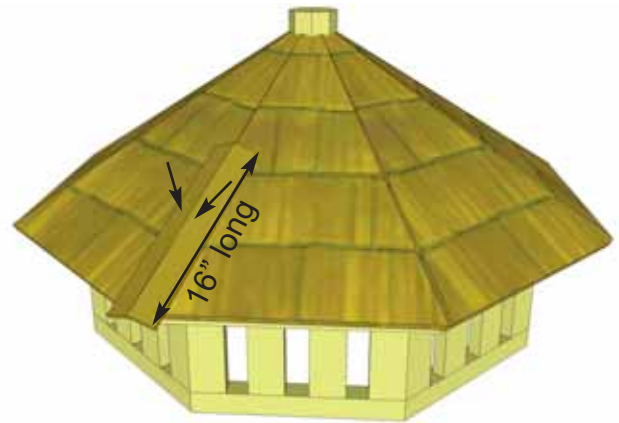

106. Locate 16" long Cupola Ridge Cap and position on corner overhanging roof by approx. 1". Secure with 2 - 1 1/4" shingle nails 10" from butt.

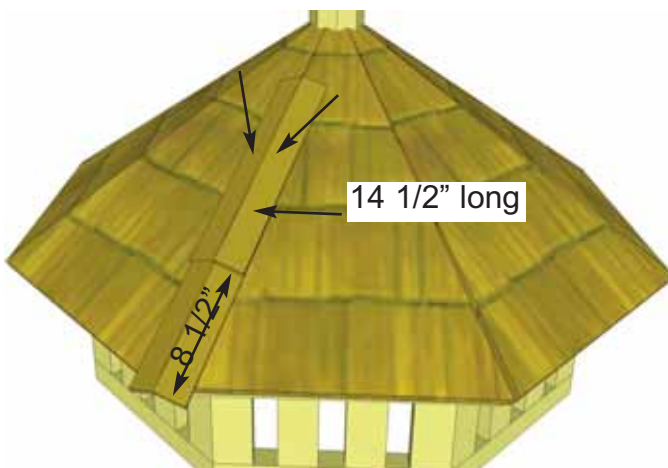

107. Place a 14 1/2" long Cupola Ridge Cap 8 1/2" from the butt of first cap. Secure with 2 - 1 1/4" shingle nails 10" from butt.

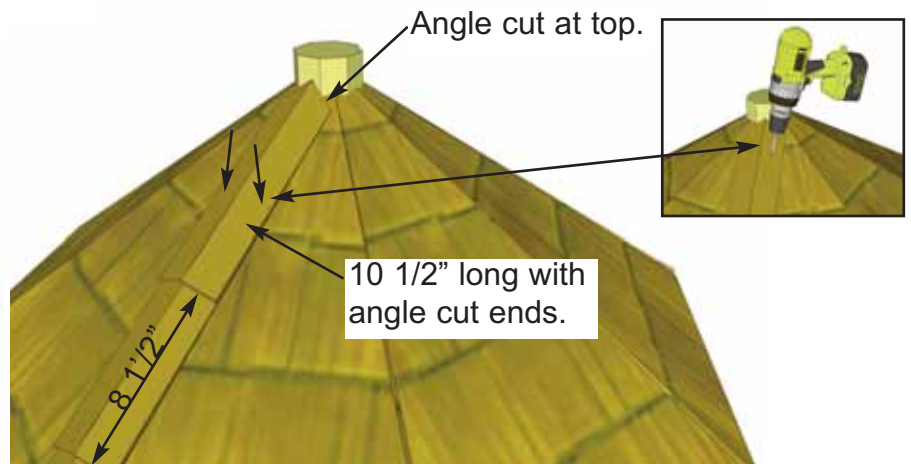

108. Place a 10 1/2" angle cut end Cupola Ridge Cap over 2nd cap 8 1/2" from butt and secure with 2 - 1 1/4" shingle nails. Drill pilot holes to prevent splitting first.

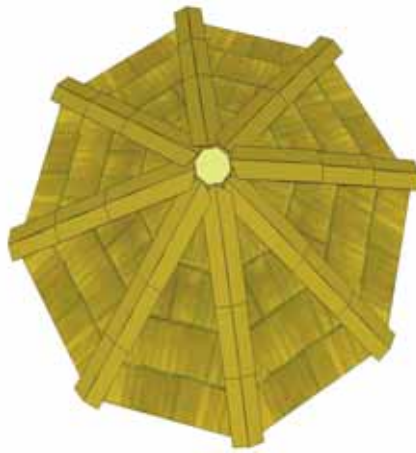
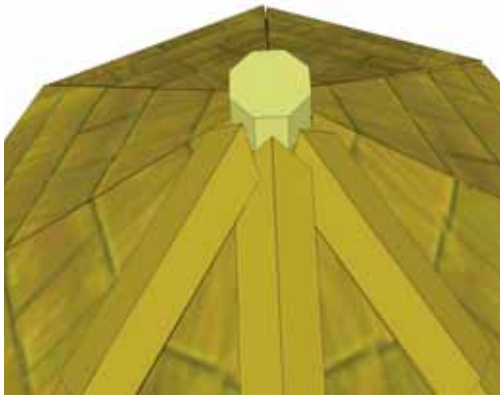

109. Complete remaining Cupola corner Ridge Caps as per **Steps 106-108** going around in a windmill design.

110. Locate and place Top Cap / Ball Top on top of Core Block.

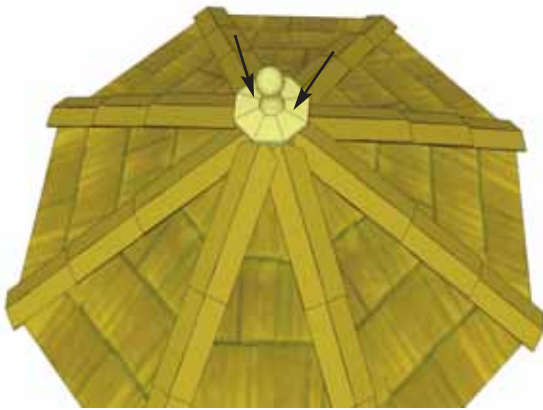

Important- Placing Cupola on Roof requires heavy lifting. Your helper will need to be positioned on the roof. Pick Cupola up by the Side Rail Sections only.

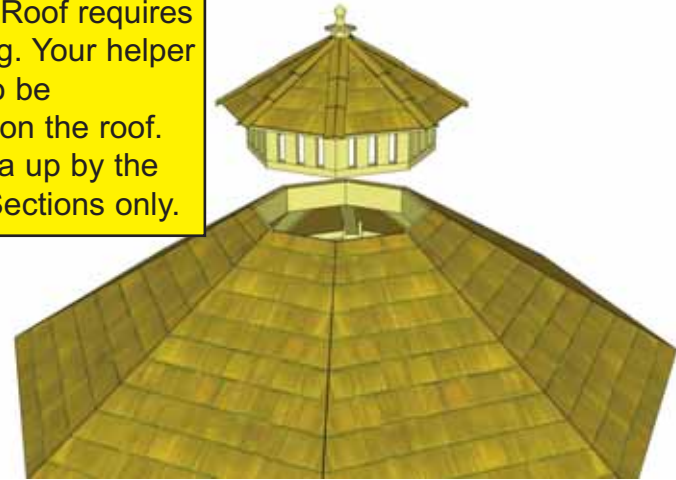

111. Prior to attaching Top Cap / Ball Top to Core Block, drill pilot holes to prevent splitting of wood. Once complete, secure with 2 - 2" screws.

112. With your helper, lift completed Cupola up on top of gazebo roof. Lift Cupola from the Side Rail Sections.

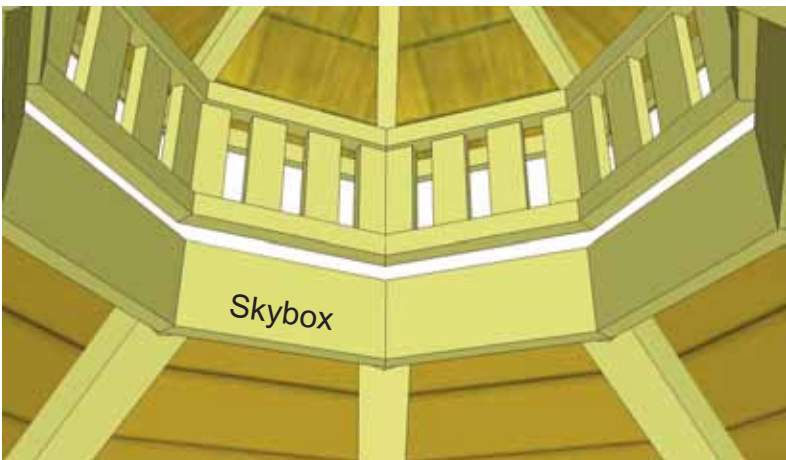

113. Place Cupola so bottom of Side Rail Section sits on top of Skybox. See **Step 114.** for alignment.

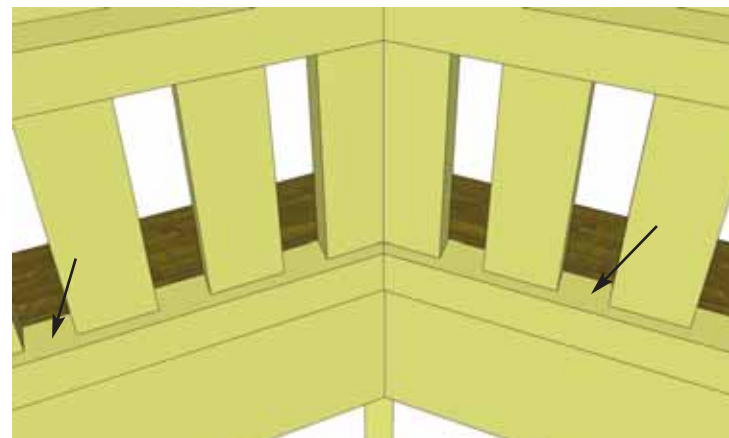

114. With Side Rails sitting on Skybox evenly, secure with 8 - 3" screws from the inside.



115. Picture above shows illustration of completed Cupola on gazebo.



116. Next, time to install **Filler Shingles** to completely secure gazebo roofs and hide roof seams. Starting on bottom row of shingles, push a Long Filler Shingle (5 1/2" wide) underneath shingles directly above it until end is flush with bottom shingles.

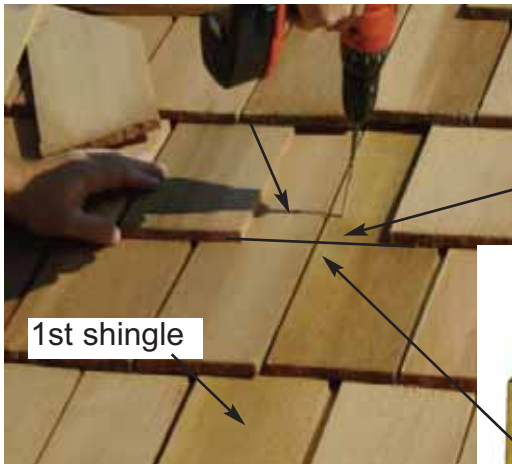

117. With a 3" screw, secure Roof Panel down into Mid Rafter above Exposure line. Screw both left and right Roof Panels down to Mid Rafters. Make sure to screw into rafter above the exposure line to conceal screw.

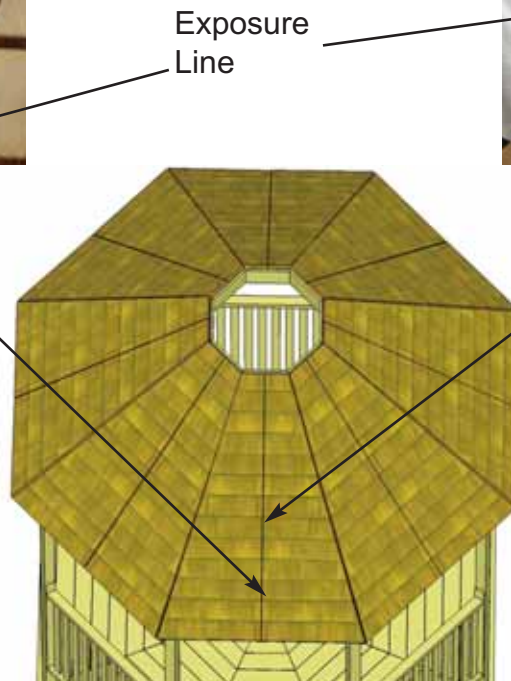

118. Slide in the next long Filler Shingle and attach as per **Step 117**. Continue until top row. On top row, slide in **Short Filler Shingle** and attach with 3" screw into Mid Rafter. **Important** - Work around the gazebo making sure to slide in all Filler Shingles and attach Roof to Mid Rafter as per **Step 117**.

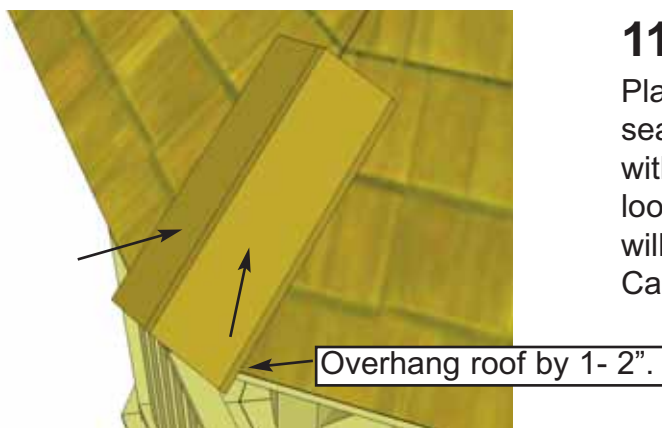

119. Locate all Gazebo **Ridge Caps**. Place 1st Ridge Cap (undercourse) on roof seam slightly overhanging roof end and attach with 1 1/4" Shingle Nails. Use less desirable looking Ridge Caps for the undercourse as it will be covered almost completely by the next Cap.

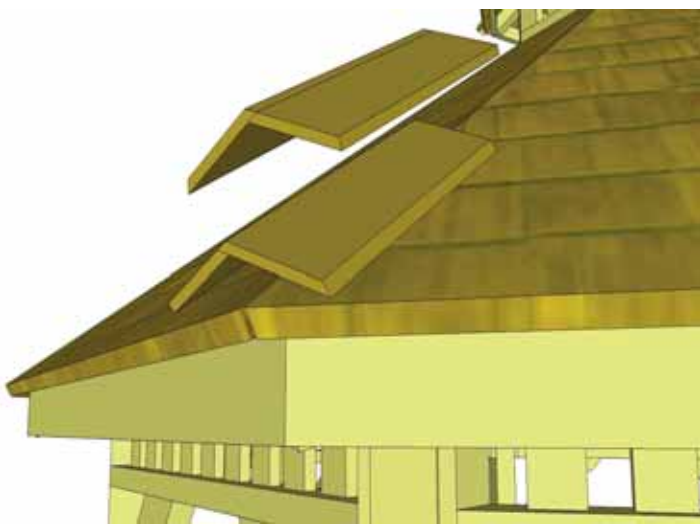

120. Locate and place 2nd Ridge Cap on top of first cap slightly recessed back.

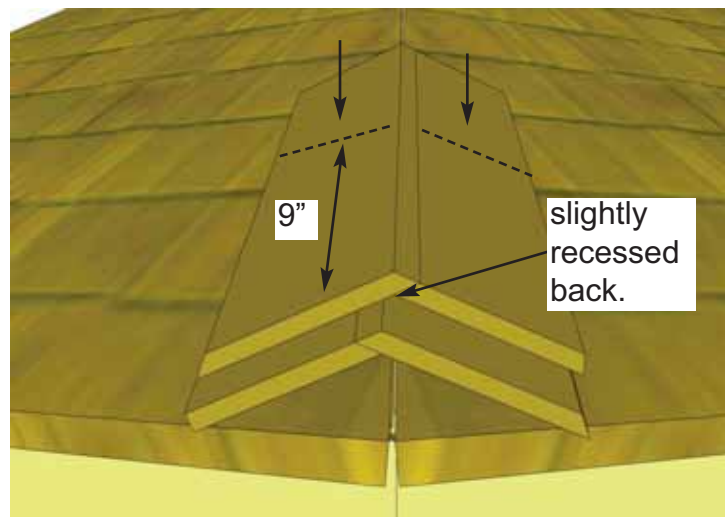

121. Attach 2nd Ridge Cap approx. 9" from shingle butt with 2 - 1 1/4" shingle nails.

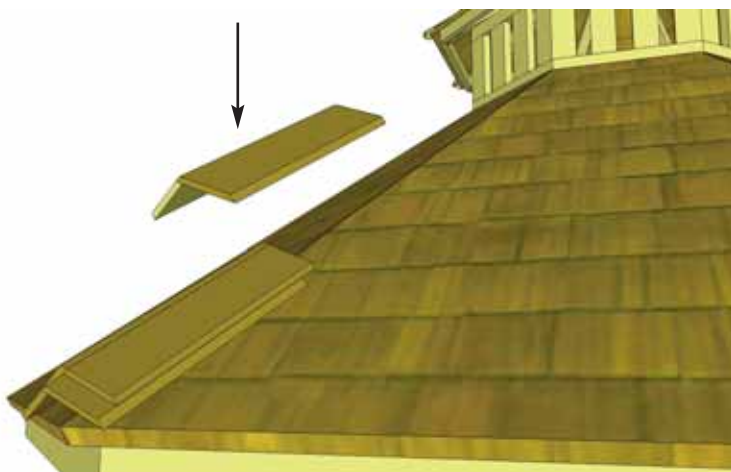

122. Place 3rd Ridge Cap on roof seam.

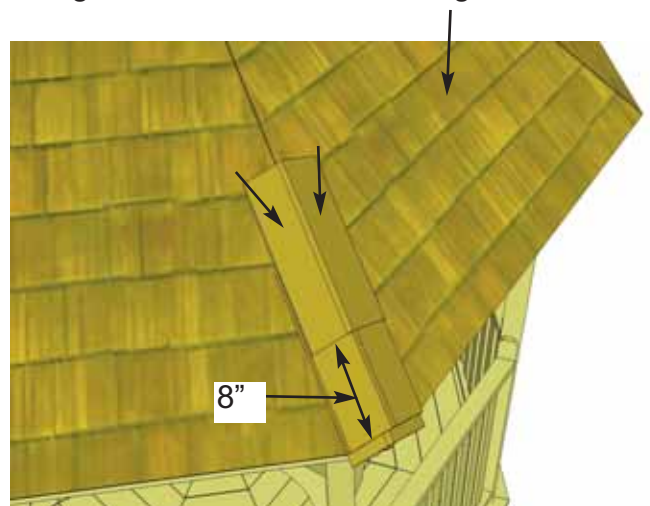

123. Start the 3rd Ridge Cap approx 8" from bottom of 2nd Ridge cap butt. Attach with 2 - 1 1/4" shingles nails 9" from butt.

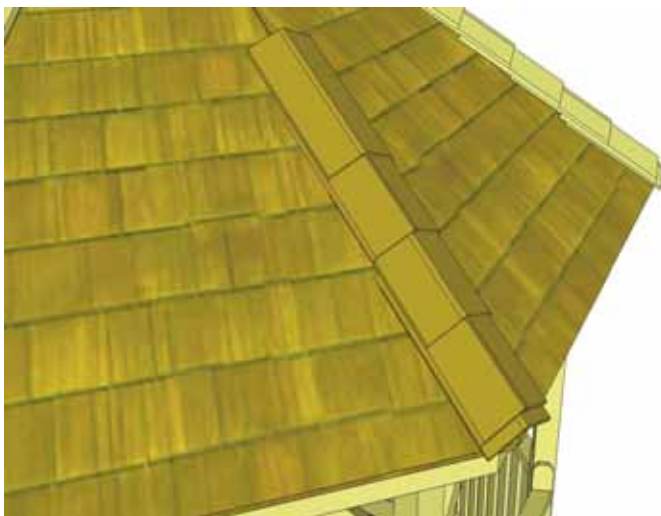

124. Continue to attach Ridge Caps positioning and securing as per **Steps 120-121.**



125. The last Ridge Cap to complete a side is cut to 10" to fit roughly against the Cupola.

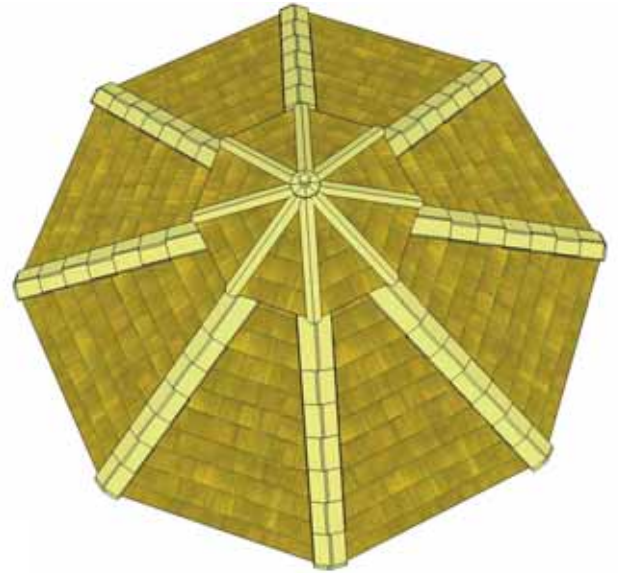
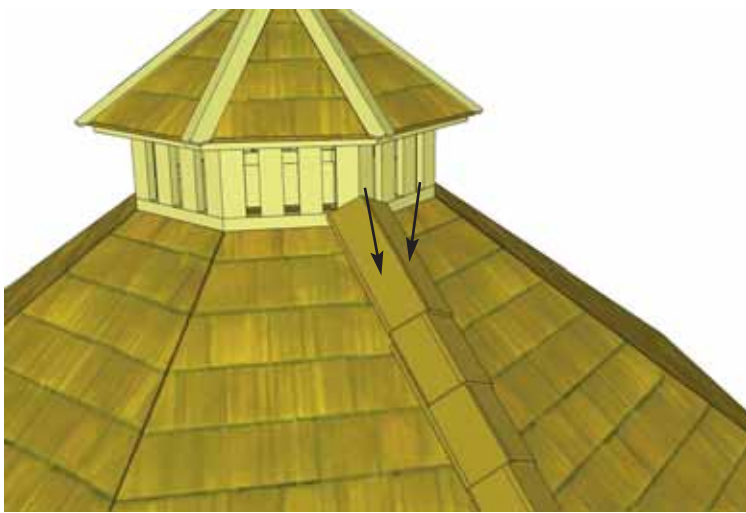

126. Attach final Ridge Cap with 2 - 2" screws. Complete all Ridge Caps to cover all roof seams.

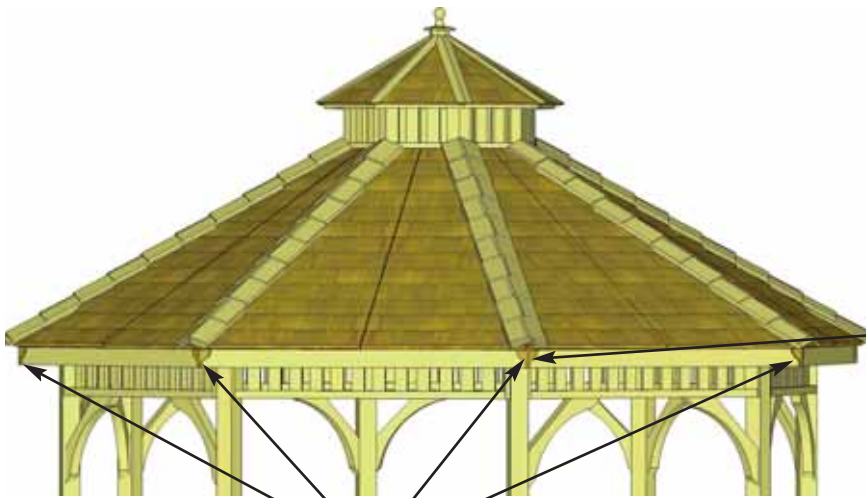

Facia Detail Plate

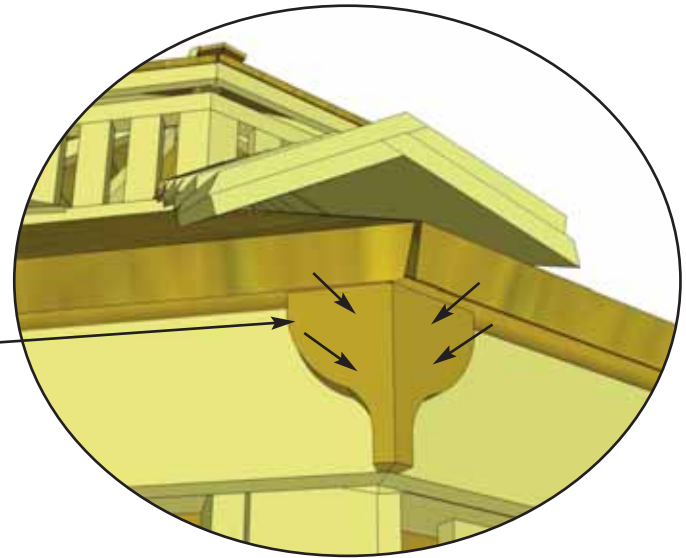

127. Locate **Facia Detail Plate** and place in each corner where Facia Boards come together. Detail Plates will hide any gaps that may exist between both Facia Boards. When centered in each corner of Facia, attach with 4 - 1 1/2" finishing nails per plate.



Rim Joist
Corner Detail
Plates

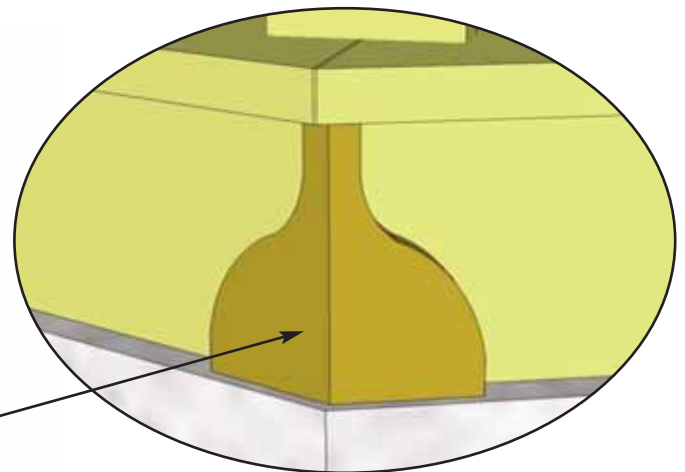

128. Position Rim Joist Corner Detail Plates in each corner where Rim Joists come together to hid the gap. Attach with 4 - 1 1/2" finishing nails per plate.

Congratulations on assembling your 12ft Bayside Gazebo!

Note: Our Gazebos are shipped as unfinished products. If exposed to the elements, the western red cedar lumber will weather to a silvery-gray color. If you prefer to keep the cedar lumber looking closer to the original color, we suggest that you treat the wood with a good oil base wood stain. You may also wish to paint your new Gazebo rather than stain it. In both cases we recommend that you consult with a paint and stain dealer in your area for their recommendations.



We hope your experience assembling your 12ft Bayside Gazebo has been both positive and rewarding.

We value your feedback and would like to hear back from you on how well we are doing in the following areas:

1. **Customer Service**
2. **On Time Shipping**
3. **Motor Freight Delivery**
4. **Quality of Materials**
5. **Assembly Manual**
6. **Overall Satisfaction.**

Please call, write or email us at:

Outdoor Living Today

Canadian Address
9393 287th Street
Maple Ridge, British Columbia
Canada V2W 1L1

United States Address
P.O. Box 96
Sumas, Washington
USA 98295



The materials contained in this Assembly Manual may be downloaded or copied provided that ALL copies retain the copyright and any other proprietary notices contained on the materials. No material may be modified, edited or taken out of context such that its use creates a false or misleading statement or impression as to the positions, statements or actions.