

HOME DECORATORS COLLECTION

HDC#: 0567400410

MFG#: 10809-VS31L

ASSEMBLY INSTRUCTION

Made in China

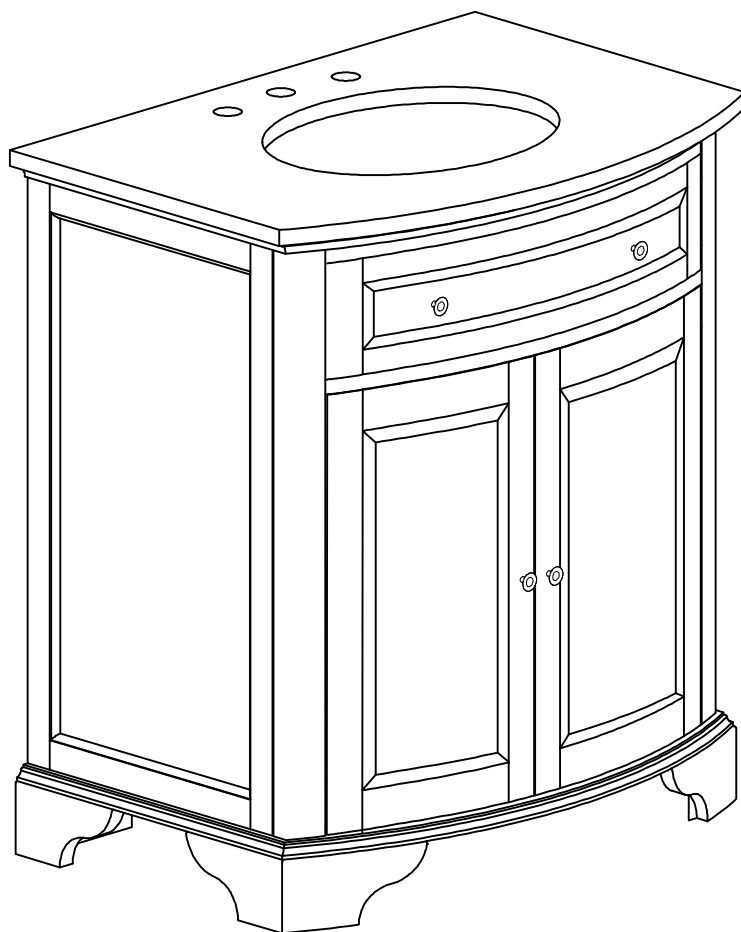

Faucet And Drain Not Included

Page 1 of 3

Please assemble this item on a clean, soft surface to prevent damage.

PARTS LIST

A



1PC

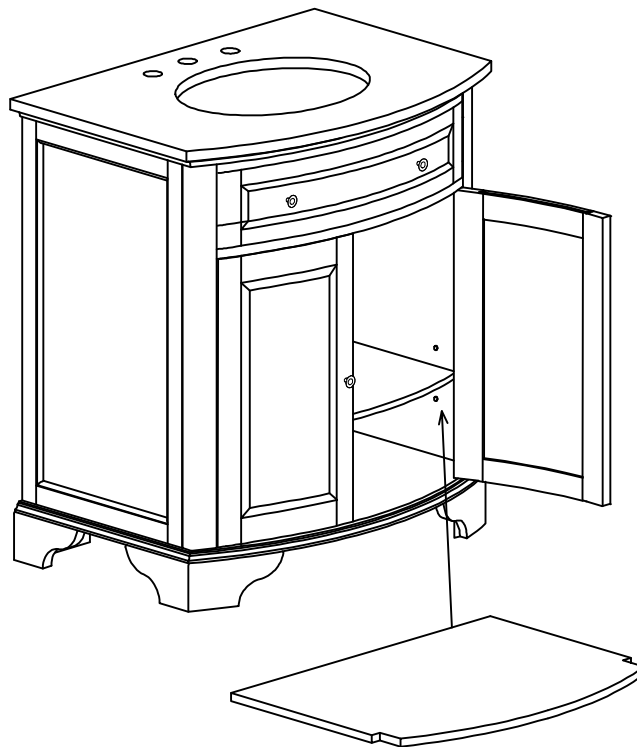

To adjust the shelf, please use a screwdriver to remove the 4 screw inserts and shelf support brackets which are under the shelf. Move the shelf and place the support bracket into the pre-drilled insert holes. Then secure with screw inserts.

HOME DECORATORS COLLECTION

Granite counter tops are surprisingly resilient to stains, and practically impossible to scratch. However, as a preventative measure, any spills on Granite surfaces should be wiped up within a reasonable amount of time. Don't let liquid sit on the stone overnight. Granite is most prone to staining by oil and acid, so be sure to blot these spills up as soon as they happen. Follow up by cleaning the stone with a mild non-abrasive soap and water.

In bathrooms specifically, Granite tends to attract soap scum, just like man-made tile. Rinse vanity top with clean, hot water frequently.

The use of sealers is also a powerful preventative measure. Your stone was sealed at the factory, but reapplication is necessary over time. How often is determined by the quality of the sealer used, and the frequency of use. We recommend using a penetrating sealer for bath areas, as a food-safe sealer is typically not necessary.

If stains and scratches DO occur, there are many things you can do as a consumer to remove them. Remove old based stains with acetone, mineral spirits, or ammonia. Organic stains like coffee, tea, or juice can be removed with hydrogen peroxide, mixed with a few drops of ammonia.

Water spots or rings are the most common problem with bath vanities, and are caused by minerals left behind when water evaporates. These can be removed by buffing the spots gently with 00 gauge steel wool. Likewise, small nicks and scratches can often be removed the same way. Larger scratches, chips, and resilient stains may require professional help. Please contact your local stonemason for details.

Remember the following list of DOs and Don'ts:

- ~DO use preventative cleaning measures to keep your stone pristine.
- ~DO use sealers, applied to according to the product specific directions.
- ~DO blot spills quickly, and wash with mild soap and warm water.
- ~DON'T use harsh bathroom cleaners or grout cleaners on any natural stone.
- ~DON'T worry if you get a significant stain or scratch that your stone investment is ruined. Virtually anything can be fixed with professional help.