

# ROCKSOLAR®

## PORTABLE POWER STATION User Instruction Manual Weekender (RS81)



## ABOUT THE UNIT

Congratulations on your purchase of a multi-function portable power station, we appreciate your support. Compact and ultra-lightweight, the ROCKSOLAR Weekender (RS81) is your perfect day-tripping companion. Power small electronics from cell phones and cameras to laptops and drones, charging devices up to 4x faster than a typical USB port. Weighing in at just under 2lbs, the Weekender is convenient to carry in a purse or backpack with a long-lasting battery for hiking or camping excursions and is a great backup in case of power failure. Before using this unit, please read the user manual carefully and keep it handy for reference.

## ATTENTION!

This manual is designed to help you use the product correctly; it does not include any hardware descriptions or software configuration details. If more product configuration information is required, please contact [services@rocksolars.com](mailto:services@rocksolars.com). Pictures in this manual are for reference only, and may not be an exact replica of the product itself.

## Modified Sine Wave Output

The unit provides Modified Sine Wave Output, and is compatible with AC electric appliances that work with Sinusoidal waveform (power <80W). However, devices using an AC motor will not work at full capacity on a modified sine wave. For example, an electrical fan may emit some noise using Modified Sine Wave Output. It is recommended that appliances like refrigerators, microwaves, compressors and medical devices that use AC motors use a pure sine wave inverter. This product is intended for short-term and emergency use and cannot replace normal alternating current for long-term use. Please adapt the power station to the specifications required by your electronics. Number of device charges and run times will vary depending on the make, model and use of devices.

## 【I】 PRODUCT PARAMETERS

Capacity	88.8Wh,6Ah/14.8V (equivalent 20000mAh/3.7V))
Dimensions (LWH)	144.8 x 77 x 105mm
Weight	about 1.04Kg
Built-in Battery	High Quality Lithium ion Batteries
Input Recharging	Adapter: DC19V/1.5A Solar Panel Charging: DC 15V~25V/1.2A Max
Fully Charged Time	DC19V/1.5A: 5~6 hours
USB Output	2 x USB 5V-2.4A Total:4.8A Max 2 x USB 5-12V/2A Qualcomm QuickCharge3.0 (18W Max, Total: 5V/3.4A max) 1 x USB C 5V/3A,9V/2A,12V/1.5A (PD2.0 18W Max)

DC Output	DC Output 12-16.8V/10A Total 13A Max
-----------	--------------------------------------

AC Output	110V/60Hz
AC Power	AC Continuous Output: 80W/120W Max
Bulb Type	1 x Ultra-bright LED Flashlight 1 x LED Light Panel
Power Indicator	LED Indicators
Operation temperature	-10°C - 40°C
Lifecycle	>500 times
Package include	1 x Portable Power Station 1 x Power Adapter 1 x Cigarette Lighter Adaptor 1 x User Manual

※ Pictures in this manual are for reference only, and may not be an exact replica of the product itself.

## 【II】 PRODUCT DESCRIPTION

### 【Top】

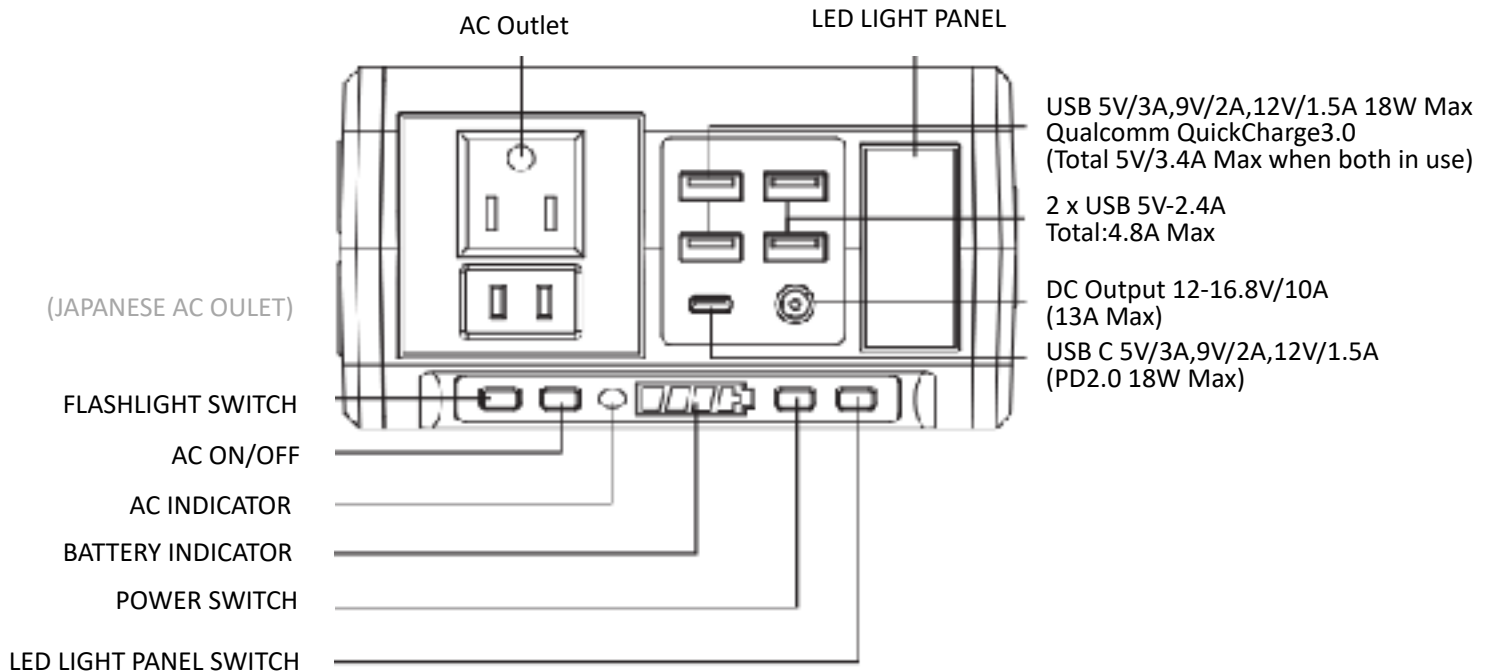

**【LEFT】**

**【RIGHT】**

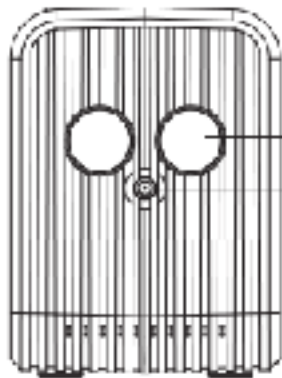

Ultra Bight LED Flashlight  
3.5MM/1.35mm DC Input  
Quick Recharging



Cooling vents

### **【III】 PRODUCT INSTRUCTION**

#### **1) How to power for DC12V appliances (head lamp, fan, etc.) with this product:**

Plug your devices into the DC output port and press the power switch button to gain power. DC output rated Current: 10A , Max output Current<13A. Note: Confirm that your DC12V appliance supports charging with 5.5mm DC header interface (the diameter of the DC Port of the product is 5.5mm). If not, an adapter may be necessary to connect with the DC output correctly. Please consult the electrical manufacturer to purchase the necessary adapter if needed.

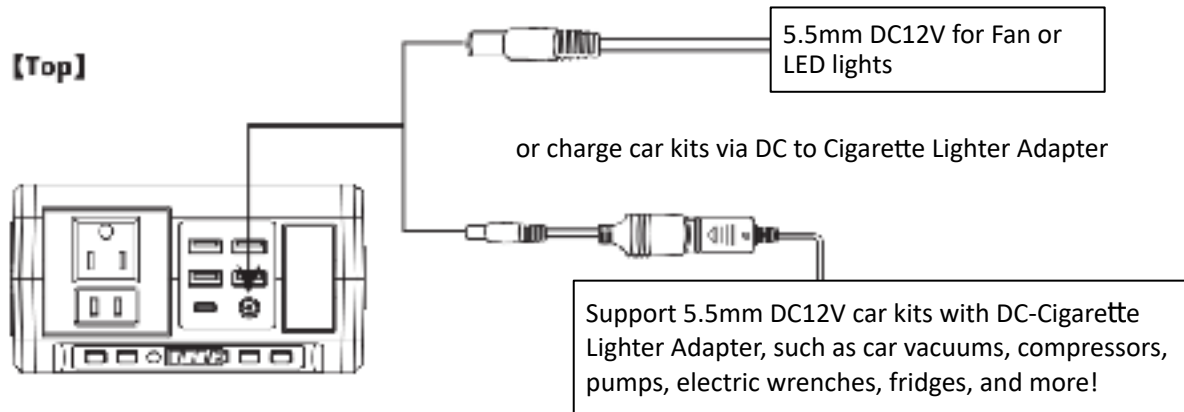

#### **WARNING!**

Note: The DC output voltage ranges between 12V~16.8V with a maximum output current of 13A. DC output voltage drops or increases while battery capacity drops or increases due to chemical characteristics of the battery. If your appliance does not have built-in input voltage stabilizing function, **it may shutdown when input voltage is too low or too high. If your 12V devices cannot work due to high input voltage, please read the device manual or consult the device manufacturer to get the input voltage range of your device.**

### Protection Mode:

Short-circuit/Overpower Protection: If the DC output is short-circuited or over powered (Load(s) power>150W), the unit will shutdown to protect itself. Please clear the problem and recharge the unit to recover from protection mode.

### 2) How to provide power for AC appliances with this product:

Connect the power cable plug of the electrical appliance to the AC outlet of the product, switch on the power button and the unit will start providing power to your appliances.

#### WARNING!

AC outlets, voltage and frequency are different in different countries. Please carefully check whether the product specifications are consistent with the appliance specifications before use to avoid malfunction.

**【Top】**

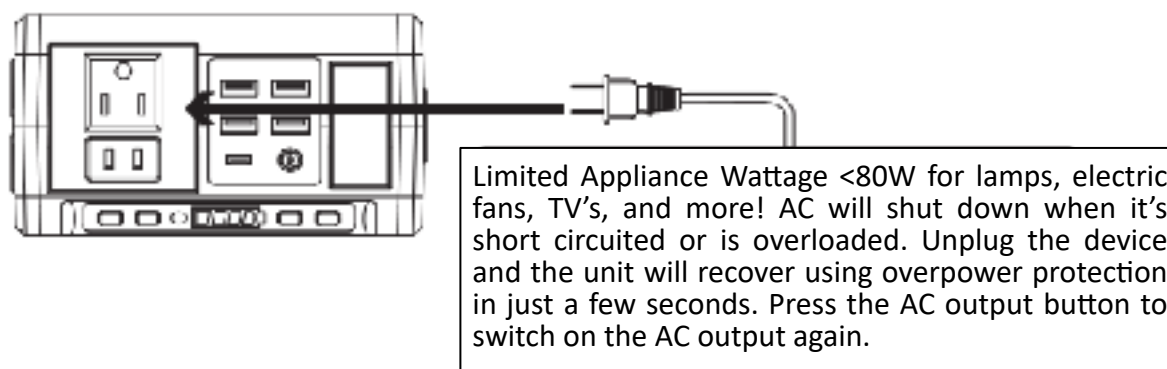

**When the AC port is not in use, turn it off to conserve power.**

### Protection Mode:

**Short-circuit/Overpower Protection:** If the AC output is short-circuited or overpowered (load(s) power>80W), the unit will shutdown AC output to protect itself. Please unplug the device and press the AC output button to switch on the AC output again. Some devices, such as refrigerator, ice maker or a laser printer may require a surge power to start or work during a very time period, the surge power could exceed 120W or even higher, this could cause overpower protection with this unit. Please remove the devices and consult with the device manufacturers for more information. Please clear the problem and re-press the AC button for AC output.

### 3) How to provide power for USB & USB-C digital devices with this product:

Connect the standard USB cable of the device to the unit's USB output, press the "O" to turn on USB output. Note: Some smart devices, such as Bluetooth headphones and LED lights require very small input current to charge, which could be less than 150mA. The unit may fail to charge these kinds of smart devices due to detection current limitation by the USB output ports. In this case, the user can press the AC button "D" to keep the USB port output running. Please turn off AC output when the smart-devices are fully charged to save power.

**Quick Charge Output:** This product supports Qualcomm QuickCharge 3.0 and USB-C PD (Power Delivery) 2.0 Output, support: 5V/3A,9V/2A,12V / 1.5A 18W, the max output for smart-devices, which also supports Qualcomm QuickCharge 3.0 or USB PD2.0 Protocol. The actual output voltage and current depends on the individual smart-devices, which can be obtained by consulting the smart-device manufacturer.

**【Top】**

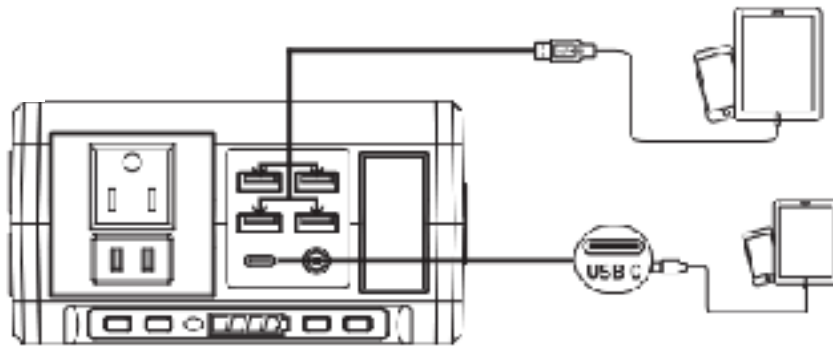

#### **4) How to use the flashlight:**

This unit is equipped with an ultra-bright LED flashlight. Press the “” button to switch on the flashlight and single press the button to switch it to blink/SOS mode. Press the button to switch off.

**WARNING! Do not point directly at eyes as the strong light may cause damage.**

#### **5) How to use the LED light panel:**

This unit is built with LED light panel. Press the “” button to switch on light panel and single press the button to switch brightness, Press the button again to switch off.

**WARNING! Do not point directly at eyes as the strong light may cause damage.**

#### **6) How to charge the unit:**

##### **a. Charge with AC Wall Charger**

Using the included AC Wall Charger, plug the unit into any wall outlet to charge the unit. You will know the unit is charging when the blue LED battery indicators are blinking. The unit is fully charged when all battery indicators stop blinking and remain solid. After the unit is fully charged, please unplug the AC wall charger.

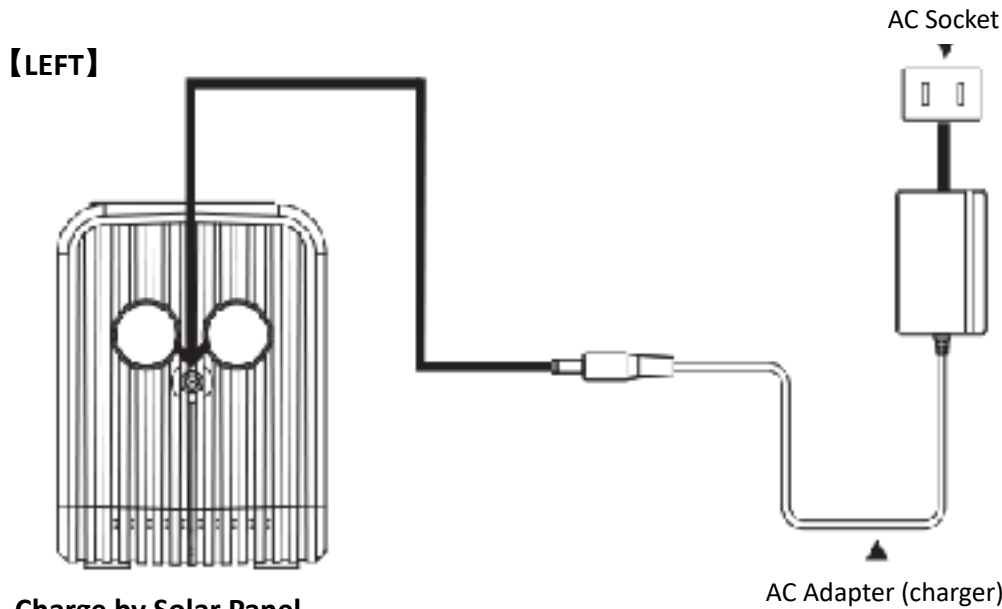

### b. Charge by Solar Panel

1. Place your solar panel where it will get as much direct sunlight as possible.
2. Plug the output of the solar panel into the input of the unit to start charging. You will know the unit is charging when the blue LED Battery Indicator lights up and blinks. The unit is fully charged when all battery indicators stop blinking and remain solid.

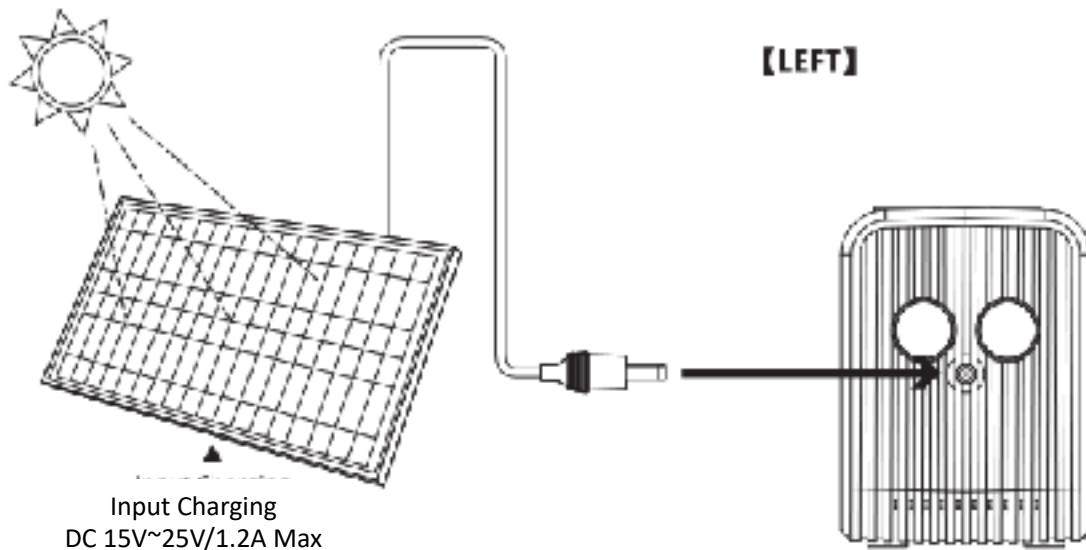

## 【IV】 SECURITY AND MAINTENANCE

- a) Do not short-circuit the unit. To avoid short-circuiting, keep the unit away from all metal objects (e.g. coins, hair-pins, keys, etc.).
- b) Do not heat the unit, or dispose of it in fire, water or other liquids. Keep away from high temperatures. Do not expose the unit to direct sunlight.
- c) Keep away from high humidity and dusty places.
- d) Do not disassemble or reassemble this unit.
- e) In order to extend the life of this lithium battery product, it is best to charge within the first 3 months of purchase and then charge at least every 6 months.

- f) Do not drop, place heavy objects on, or allow strong impact to this unit.
- g) This device is not intended for use by children or those with reduced physical, sensory or developmental capabilities. Those who lack experience with technology should only operate with supervision or instruction by a capable person who claims responsibility for their safety. This device is not a toy.
- h) Do not cover the device with towels, clothing and other items.
- i) The unit may become hot when charging, but do not worry, this is normal. Use caution when handling.
- j) Do not charge the unit over the required time.
- k) Disconnect the unit when fully charged.
- l) Use the unit properly, as instructed, to avoid electronic shock.
- m) Please discard scrap products in accordance with e-waste regulations. Do not treat the built-in battery as a household garbage.
- n) The product is only intended for temporary use and emergency situations. It cannot replace the standard DC or AC power of household appliances or electronic devices.

## **【V】 PRODUCT APPLICATION SKILLS**

- a) This product contains high quality original lithium ion battery. It has no memory storage but is a high-capacity, durable product.
- b) Use within the temperature range of 10°C~30°C, to obtain the optimal charging capacity.
- c) Avoid interference when charging, please keep this device away from TV, radio and other equipment.
- c) If the device has not been used for a long time, please disconnect the cable and place in dust-free storage.
- d) Some portable devices may need to be set in charge mode to charge. Refer to the product device manual for more information.
- e) In order to extend the life of this lithium battery product, it is best to charge within the first 3 months of purchase and then charge at least every 6 months.

## **Cold Weather Usage**

Cold temperatures (below freezing) can affect the unit's battery capacity due to chemical characteristics of the battery. If you'll be living off-grid in sub-zero conditions, we recommend you keep your unit in an insulated cooler, and connected to a power source (solar panels). The natural heat generated by the unit contained in an insulated cooler will keep battery capacity at its highest.

## **Recycle**

Always return your used electronic products, batteries, and packaging materials to dedicated e-waste collection points. This will help prevent uncontrolled waste disposal and promote the recycling of materials.

## **Battery Information**



Your device has an internal non-removable, rechargeable battery. Do not attempt to remove the battery, as you may damage the device. The battery can be charged and discharged over 500 times, but it will eventually wear out.

### **Statement**

All rights reserved. Reproduction in whole or in part without written permission is prohibited. All other trademarks are trademarks of their respective owners. Features and specifications are subject to change without notice.

## **Limited Warranty**

ROCKSOLAR LLC. provides a non-transferable warranty to the purchaser of ROCKSOLAR products purchased from an authorized reseller. ROCKSOLAR LLC. warrants to the original consumer purchaser that the ROCKSOLAR product will be free from defects in workmanship and material under normal consumer use during the applicable warranty period identified in the 'Warranty Period' section below, subject to the exclusions set forth below. This warranty statement sets forth ROCKSOLAR's total and exclusive warranty obligation. ROCKSOLAR will not assume, nor authorize any person to assume for us, any other liability in connection with the sale of our products.

## **Warranty Period**

The warranty period is 24 months. In each case, the warranty period is measured starting on the date of purchase by the original consumer purchaser. The sales receipt from the first consumer purchase, or other reasonable documentary proof, is required in order to establish the start date of the warranty period. Purchasers can register their devices at [rocksolars.com](http://rocksolars.com).

## **Troubleshooting**

ROCKSOLAR's troubleshooting solution for any ROCKSOLAR product that is not operating in accordance with its published technical specifications is at ROCKSOLAR's discretion, but its policy is to replace the product at ROCKSOLAR's expense. This warranty obligation is conditioned upon the hardware being returned to the original place of purchase, or return as directed by ROCKSOLAR, with the original sales receipt attached. You may be required to pay shipping and handling charges, as well as any applicable tariffs, duties, taxes, or other fees. ROCKSOLAR may, at its discretion, provide new or refurbished products.

## **Limited to Original Consumer Buyer**

The warranty on ROCKSOLAR's product is limited to the original consumer purchaser and not to any subsequent owner.

## **LIMITATION OF LIABILITY**

ROCKSOLAR SHALL NOT BE LIABLE FOR ANY UNUSUAL, INCIDENTAL, INDIRECT, OR CONSEQUENTIAL DAMAGES WHATSOEVER, INCLUDING BUT NOT LIMITED TO LOSS OF PROFITS, REVENUE, OR DATA (WHETHER DIRECT OR INDIRECT) OR COMMERCIAL LOSS FOR BREACH OF ANY EXPRESS OR IMPLIED WARRANTY ON YOUR PRODUCT EVEN IF ROCKSOLAR HAS BEEN ADVISED PREVIOUSLY OF THE POSSIBILITY OF SUCH DAMAGES. Some local laws do not allow the exclusion or limitation of special, indirect, incidental or consequential damages, so this limitation or exclusion may not apply in your jurisdiction.

## Exclusions

The warranty does not cover failures resulting from incorrect handling, product modifications, installation, conversion or additions, supplemental use, incorrect operation, natural elements (weather), excessive or deficient energy supply, chemicals, the effect of solid bodies or deliberate damage. If the Warrantor determines that the problem with the ROCKSOLAR product(s) is not due to a manufacturing defect in the Warrantor's workmanship or materials, or otherwise does not qualify for warranty repair, then the Purchaser will be responsible for all costs incurred by the Warrantor necessary to repair, replace and transport the ROCKSOLAR product(s). ROCKSOLAR's warranty does not apply to the battery cell unless the battery cell is fully charged by you within seven days after you purchase the product and at least every 6 months thereafter.

## How to Receive Service

To obtain service, contact our customer service team at [services@rocksolars.com](mailto:services@rocksolars.com).

## Contact us

ROCKSOLAR TECHNOLOGY LLC.

Address: 6585 Arville Ave, STE A, Las Vegas, NV 89118, USA

Email: [services@rocksolars.com](mailto:services@rocksolars.com)

Website: [www.rocksolars.com](http://www.rocksolars.com)



This device complies with part 15 of the FCC Rules. Operation is subject to the following two conditions:

(1) This device may not cause harmful interference, and  
(2) this device must accept any interference received, including interference that may cause undesired operation.



MADE IN CHINA