

HOW TO INSTALL THIS CYLINDRICAL LEVERSET

Leverset is set for 1-3/4" thick door - Backset 2-3/4"

*THRUBOLTS ARE PROVIDED AND RECOMMENDED FOR USE IN HIGH SECURITY DOORS.

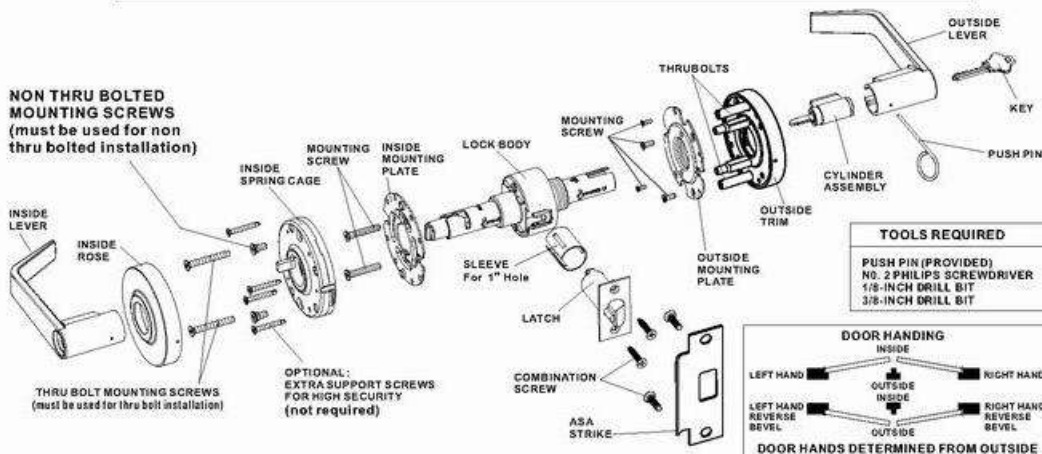

1 DOOR PREPARATION

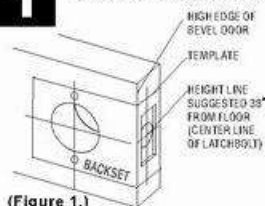

1. Check lock for proper backset and body outside stud bolt type before drilling.
2. Place paper template (supplied) on the door and mark for holes.

Drill the cross-bore holes, and then the latch holes.

NOTE:

Cut notches on 2-1/8" cross-bore hole on both sides for steel or wood doors (Refer to fig. 2)

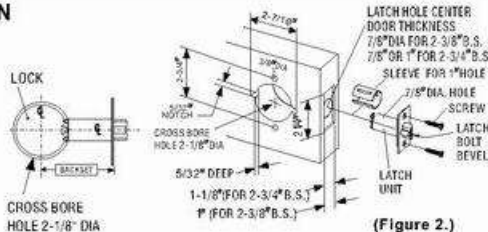

3. Drill (2) 3/8" thru bolt holes half way thru from each side of door to prevent damaging door unless lock is to be installed without thru bolts then skip to step 4.
4. Markise latch unit from 5/32" into door edge to dimensions shown in fig. 2.
5. Insert latch unit with sleeve if hole is 1" dia. or without sleeve into 7/8" dia. Make certain that latch bolt bevel faces direction of closing door.
6. Drill two 1/8" dia. holes and secure latch unit with combi-screws supplied.

2 DISASSEMBLE A LOCK

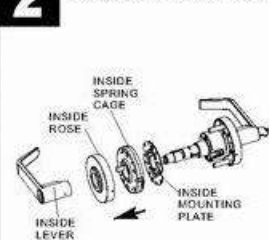

1. Use push pin to disassemble inside lever
2. Disassemble inside rose assembly and inside mounting plate.

3 INSTALL LOCK ONTO DOOR

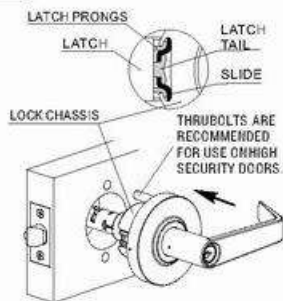

3A: Place lock body into position. Make sure

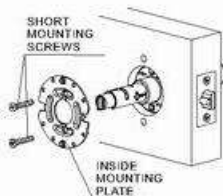

3B: Install inside mounting plate with short mounting screws.

Note: OPTIONAL if using thru bolts.

IMPORTANT

If the door is thicker than 2", the catch will be covered by inside rose, do not install inside lever and lock.

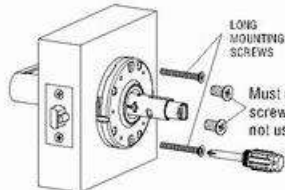
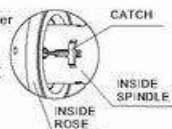

3C: Install inside spring cage with long mounting screws for thru bolt installation or short mounting screws for non thru bolted installation