

OWNER'S MANUAL

ONE-PERSON & TWO-PERSON SAUNAS

WITH CERAMIC OR CARBON HEATERS



**Please Do Not Hesitate to
Contact Our Consumer Hotline
at 800-759-0977
with Any Questions That May
Arise During Assembly or
Use of This Product!**

SA2400/SA2406/SA2409/SA1309

TABLE OF CONTENTS

ASSEMBLY TIPS & WARNINGS	3
PARTS IDENTIFIER	4
ASSEMBLY INSTRUCTIONS	5-10
OPERATION INSTRUCTIONS	11
ENJOYING YOUR SAUNA	12
HEALTH & SAFETY WARNINGS	13
CLEANING & MAINTANENCE	14
TROUBLESHOOTING GUIDE	14-15
REPLACEMENT PARTS	16-23
WARRANTY INFORMATION	24

If you would like a French version of this manual, please contact our Customer Service Department at 800-759-0977 or custserv@splashnetxpress.com

Si vous voulez une version française d'un manuel, s'il vous plaît contacter notre service à la clientèle au 800-759-0977 ou custserv@splashnetxpress.com

The information contained in this manual is subject to change without notice.

ASSEMBLY TIPS & WARNINGS

- Before you begin, read all assembly instructions and safety warnings carefully.
- This sauna requires at least 2 adults to complete assembly.



- Remove all of the contents from boxes and verify that you have all of the parts shown on the Parts Identifier before you begin assembly. *Note: Some parts may be pre-installed or pre-assembled.*
- This manual is used for the assembly of several sauna models; therefore, some figures or drawings may not look exactly like your product.
- Cover the sauna floor during assembly to avoid staining the unfinished wood surface.
- Retain this Owner's Manual for future reference.

ELECTRICAL REQUIREMENTS

- We recommend consulting a licensed electrician and checking local ordinances before installing ANY sauna.
- This sauna requires a standard 15 amp receptacle.





























- Refer to the serial plate on the back of the sauna for complete electrical specifications.
- This sauna requires a dedicated circuit - No other appliances should share the same outlet with the sauna.

CHOOSING A LOCATION

- This sauna should only be placed INDOORS on a dry, level surface.
- There should be a minimum of 5 inches clearance between the sauna and any wall.
- Make sure the main power cord will reach the outlet and remains easy to access.
- The sauna should only be used in a dry location as moisture will damage the wood and electrical components.
- Keep the sauna away from any potential hazards including water sources, flammable objects and combustible materials.

PARTS IDENTIFIER (NOT TO SCALE)

 FRONT PANEL WITH GLASS DOOR	 LEFT PANEL	 RIGHT PANEL	 BACK PANEL	 ROOF
 ROOF COVER	 FLOOR	 FLOOR HEATER²	 BENCH SEAT	 BENCH HEATER PANEL
 BACK PANEL HEATER COVER¹	 BACKREST	 DOOR HANDLE	 STEREO SHELF	 AM/FM CD PLAYER WITH MP3 INPUT⁴
 CUP HOLDER	 MAGAZINE RACK	 DOUBLE TOWEL HOOK³	 COLOR THERAPY CONTROL PANEL³	 OXYGEN IONIZER³
 2" (50mm) SCREW⁵	 1-1/2" (40mm) SCREW⁵	 1-1/8" (30mm) SCREW⁵	 3/4" (20mm) SCREW⁵	¹ Ceramic Heater Models Only ² Carbon Heater Models Only ³ Two-Person Models Only ⁴ Stereo audio cable with 3.5mm (1/8") TRS connector (mini-stereo jack) not included ⁵ Extra hardware is included - It is normal to have extra screws leftover when sauna assembly is complete
ADDITIONAL EQUIPMENT REQUIRED:  PHILLIPS HEAD SCREWDRIVER	 STEP LADDER	<i>This manual is used for the assembly of several sauna models; therefore, some images or drawings may not look exactly like your product.</i>		

* Refer to REPLACEMENT PARTS (PAGE 16-27) to determine the correct part number when ordering replacements.

ASSEMBLY INSTRUCTIONS

1. Begin assembly by determining an appropriate location for your sauna – see ASSEMBLY TIPS & WARNINGS for details. Attach the BACK PANEL to the FLOOR by lining up the BACK PANEL with the groove in the back of the FLOOR.



2. Attach the LEFT PANEL to the FLOOR. Buckle the LEFT PANEL to the BACK PANEL.



3. Attach the RIGHT PANEL to the FLOOR. Buckle the RIGHT PANEL to the BACK PANEL.



ASSEMBLY INSTRUCTIONS (CONT.)

4. **Carbon Heater Models Only:** Attach the FLOOR HEATER to the FLOOR with 1-1/2" SCREWS. Connect the heater plug.

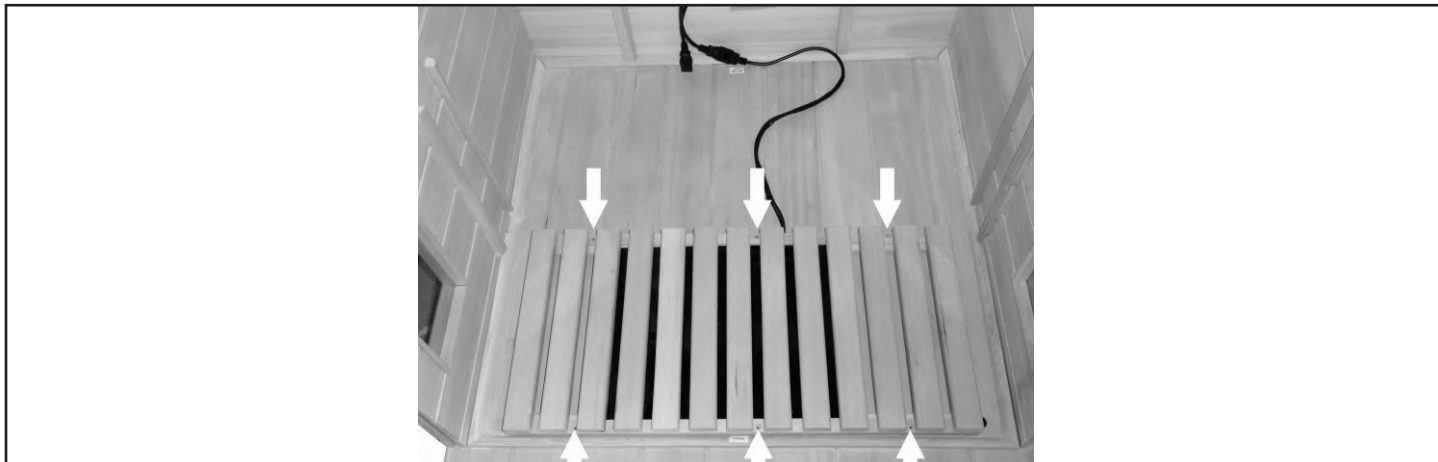

5. Slide the BENCH HEATER PANEL into place between the LEFT and RIGHT PANELS. Connect the heater plug. *Note: For Carbon Heater Models, make sure the FLOOR HEATER cable is placed through the groove in the bottom of the BENCH HEATER PANEL.*



6. Attach BENCH SEAT with 2" SCREWS.



NOTE: When performing Step 5 above, you may need to skew the wall out slightly to accommodate inserting the BENCH HEATER PANEL.

ASSEMBLY INSTRUCTIONS (CONT.)

7. **Ceramic Heater Models Only:** Attach BACK PANEL HEATER COVER to BACK PANEL with 2" SCREWS and to BENCH SEAT with 3/4" SCREWS.



8. Attach the FRONT PANEL to the FLOOR. Buckle the FRONT PANEL to the LEFT and RIGHT PANELS.



9. Lift the ROOF above the sauna, feeding the control panel and heater cables through the corresponding holes. Feed the cables for the AM/FM CD PLAYER through the hole in the bottom of the ROOF. *Note: For One-Person Models, the ROOF fits inside the four PANELS.* Secure the ROOF to the sauna with 1-1/8" SCREWS. Connect the control panel and heater plugs.



ASSEMBLY INSTRUCTIONS (CONT.)

10. Feed the main power cable through hole in ROOF and plug securely into receptacle on back of POWER SUPPLY box. Secure the ROOF COVER with 3/4" SCREWS.



11. Attach the DOOR HANDLE to the GLASS DOOR.



12. Gently pull the cables for the AM/FM CD PLAYER through the opening in the front of the STEREO SHELF. Attach the STEREO SHELF with 3/4" SCREWS.



ASSEMBLY INSTRUCTIONS (CONT.)

13. Plug the controller and antenna into the back of the AM/FM CD PLAYER. Slide and lock the AM/FM CD PLAYER into the STEREO SHELF.



14. Attach the MAGAZINE RACK with 1-1/2" SCREWS. *Note: A sticker indicates the optimal position for this accessory, but attaching it is optional. Consider the position carefully before driving any screws into the sauna interior.*

15. Attach the CUP HOLDER(S) with 3/4" SCREWS. *Note: A sticker indicates the optimal position for this accessory, but attaching it is optional. Consider the position carefully before driving any screws into the sauna interior.*

16. **Two-Person Models Only:** Attach the DOUBLE TOWEL HOOK with 3/4" SCREWS. *Note: A sticker indicates the optimal position for this accessory, but attaching it is optional. Consider the position carefully before driving any screws into the sauna interior.*

17. **Two-Person Models Only:** Attach the COLOR THERAPY CONTROL PANEL into the designated position with 2" SCREWS.



ASSEMBLY INSTRUCTIONS (CONT.)

18. **Two-Person Models Only:** Remove the back cover of the OXYGEN IONIZER by turning it as indicated. Unwrap and install the fragrance patch, then reattach the back cover. Attach the OXYGEN IONIZER in the designated position with 3/4" SCREWS. Plug the power cable into the OXYGEN IONIZER.



19. Plug the main power cable into a dedicated outlet. *Note: No other appliances should share the same outlet with this sauna.*

CONGRATULATIONS!

The assembly of your sauna is now complete.

Please review the Operation Instructions and Health & Safety warnings before using your sauna.

To ensure years of trouble-free use, follow the Cleaning & Maintenance guidelines carefully.

OPERATION INSTRUCTIONS

SAUNA CONTROL PANEL

Note: The sauna controls are the same for both the interior and exterior Control Panels.

1. Press POWER to turn ON the sauna.
2. Set the desired TEMPERATURE with the (+) and (-) buttons.
3. Press and hold both (+) and (-) to switch between °F (Fahrenheit) and °C (Celsius).
4. Set the desired TIME with the (+) and (-) buttons.
5. Press INSIDE or OUTSIDE to turn on or off the corresponding light.
6. When the TIME reaches 00, the heaters will turn OFF automatically.
7. After your sauna session, press POWER to turn OFF the sauna.

COLOR THERAPY CONTROL PANEL (Two-Person Models Only)

1. Press POWER to turn ON the Color Therapy Light. The Color Therapy Light will cycle through all the available colors.
2. Press SELECT to locate your preferred color or pattern, then press SET.
3. Set the desired TIME with the (+) and (-) buttons, then press SET.
4. Press POWER to turn OFF the Color Therapy Light.

OXYGEN IONIZER (Two-Person Models Only)

1. Press ION to release negatively charged ions to purify the air.
2. Press O3 to disinfect the air with ozone.

ENJOYING YOUR SAUNA

1. Prior to initial use, wipe down all interior surfaces of the sauna with a damp cloth.
2. Turn on the sauna and set temperature to 104° F for one hour to burn off any factory dust.
3. Always drink plenty of water before, during and after your sauna session to stay properly hydrated.
4. A normal sauna session should last 30 minutes or less.
5. Allow approximately 15 to 25 minutes for the sauna to warm up before entering.
6. Perspiration will begin within 15 to 25 minutes after entering the sauna.
7. Limit the use of lotions or oils on your body while using your sauna. These products can block your pores and limit perspiration, decreasing the effectiveness of your sauna session.
8. For spot treatment of a particular area, position that body part closer to the heater, allowing for deeper heating in that area.
9. During your sauna session, place towels on the bench seats and on the floor to absorb perspiration and maintain the cleanliness of your sauna.
10. Towel off excess perspiration during your sauna session to help your body perspire more freely.
11. Open the ceiling vent or the front door to allow fresh air into your sauna.
12. Allow your body to cool down following your sauna session, then rinse the perspiration off your body in a warm shower.

HEALTH & SAFETY WARNINGS

1. Review all instructions and warnings before operating your sauna. A sauna is not a toy. Serious injury may result from negligence, intentional misuse and failure to follow safety instructions.
2. **Hyperthermia Danger:** Hyperthermia occurs when the body absorbs more heat than it can dissipate. When the elevated body temperatures are sufficiently high, hyperthermia is a medical emergency and requires immediate treatment to prevent disability or death. It is very important not to allow your body's core temperature to rise above 103° F. Symptoms of hyperthermia include dizziness, lethargy, drowsiness and fainting. The effects of hyperthermia may include failure to perceive heat, failure to recognize the need to exit the sauna, unawareness of the impending health hazard, physical inability to exit the sauna and unconsciousness.
3. If you are feeling uncomfortable, faint or dizzy, exit the sauna immediately.
4. Do not exceed recommended time and temperature guidelines.
5. Do not touch or interfere with the temperature sensor on the control panel.
6. Do not touch or spray water on the heater elements.
7. Do not use the sauna while under the influence of drugs or alcohol.
8. Do not sleep inside the sauna.
9. Do not use the sauna immediately following strenuous exercise. Allow your body to cool down for 30 minutes before entering the sauna.
10. Pets should never be placed in the sauna.
11. Pregnant women, children under the age of 6, the elderly and infirm should not use the sauna.
12. Children over the age of 6 should always be supervised by an adult.
13. People with health problems including open wounds, fever, sunburn or dehydration should not use the sauna.
14. People suffering from obesity or with a history of heart disease, low or high blood pressure, circulatory system problems or diabetes should consult a physician before using the sauna.
15. Consult a physician before using the sauna if you take any prescription medications.
16. Keep towels and combustible materials away from the heater elements.
17. Remove all towels and materials after your sauna session.
18. Never leave your sauna unattended while in use.
19. Always unplug the sauna and allow it to cool down before performing any cleaning or maintenance.
20. Always turn off and unplug the sauna when not in use.

CLEANING & MAINTENANCE

1. Always unplug the sauna and allow it to cool down before performing any cleaning or maintenance.
2. Use furniture polish or furniture oil when cleaning the sauna exterior.
3. The sauna interior surfaces should only be wiped down with a damp cloth. Do NOT use chemicals, abrasive cleaners or solvents on the unfinished interior wood.
4. As with all natural wood products, variations in the color and the grain as well as irregularities such as knots and fine cracks may be present. These characteristics are a part of the natural beauty of the wood and should not be considered defective.

TROUBLESHOOTING GUIDE

WARNING!

- Always unplug the sauna and allow it to cool down before performing any maintenance.
- Repairs to the electrical components of the sauna should only be performed by a qualified service technician.
- Unauthorized repairs or alterations will void the manufacturer's warranty.

Problem THERE IS NO POWER TO THE SAUNA

- Solution**
1. Check that the Main Power Cable is plugged into the wall outlet.
 2. Check that the circuit breaker for the outlet has not tripped. If the breaker has tripped, check that the amperage of the breaker is appropriate for your sauna.
 3. Check all connections to the Power Supply Box.
 4. Check for damage to the Main Power Cable; replace, if necessary.
 5. Replace the Power Supply Box, if necessary.



Problem ONE HEATER DOES NOT WORK

- Solution**
1. Check that all the connections are tight.
 2. Replace the Heater Element.

Problem NONE OF THE HEATERS WORK

- Solution**
1. Check that all connections are tight.
 2. Replace the Heater Circuit Board, if necessary.

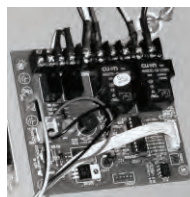

TROUBLESHOOTING GUIDE (CONT.)

Problem THE CONTROL PANEL DOES NOT WORK

- Solution**
1. Check that all the connections are tight.
 2. If the numbers are scrambled or the buttons are unresponsive, replace the Control Panel.
 3. If the temperature indicator does not work or reads "--" or "EP", replace the Control Panel.



Problem THE LIGHTS ARE NOT WORKING

- Solution**
1. Check that all the connections are tight.
 2. If one light does not work, replace the bulb. *Note: Do not touch the glass part of the bulb with your fingers during installation.*
 3. If neither the lights nor the radio are working, replace the Power Supply Box.

Problem THE RADIO AND/OR CD PLAYER IS NOT WORKING

- Solution**
1. Check that all the connections are tight.
 2. Check the fuse; replace if necessary.
 3. Replace the radio.
 4. If neither the radio nor the lights are working, replace the Power Supply Box.

Problem THE SPEAKERS ARE NOT WORKING

- Solution**
1. Check that the volume is not turned all the way down and that the fader control is set correctly.
 2. If only one speaker is working, check to see that the sound balance on the stereo is not set all the way to one side.
 3. Check that all the connections are tight.
 4. Replace the speaker, if necessary.

Problem THE COLOR THERAPY LIGHTS ARE NOT WORKING

- Solution**
1. Check that all the connections are tight.
 2. Replace the Color Therapy Light or Color Therapy Control Panel, if necessary.

REPLACEMENT PARTS

The following pages list part numbers specific to your particular sauna model. Please reference the model number at the top of each page to make sure you're using the correct list for your sauna. In the event that you need replacement parts, use these guides to reference the part number. It is important to use only replacement parts specified by the manufacturer. The use of unauthorized substitutes may damage your sauna or cause electrical hazards resulting in injury or fire.

REPLACEMENT PARTS

Rev. 5/16

SA2400 ONE-PERSON HEMLOCK SAUNA WITH CERAMIC HEATERS

REF. #	DESCRIPTION	PART NUMBER	QTY.
1	GLASS DOOR	SAP24394	1
1	GLASS CLIP - METAL	SAP2537	2
1	DOOR MAGNET	SAP25371	2
2	FRONT PANEL with GLASS DOOR	SAP26164	1
3	BACK PANEL	SAP26193	1
5	LEFT PANEL	SAP2617	1
6	MAGAZINE RACK	SAP2414	1
7	RIGHT PANEL	SAP2618	1
8	ROOF	SAP26205	1
9	ROOF COVER	SAP2601	1
10	BENCH HEATER PANEL	SAP2503	1
11	BENCH SEAT	SAP2504	1
12	FLOOR	SAP2505	1
14	AM/FM CD PLAYER with MP3 INPUT	SAP24085	1
15	DOOR HANDLE	SAP2413	1 SET
16	CONTROL PANEL	SAP2406	1
17	MAIN POWER CABLE	SAP2703	1
18	CUP HOLDER	SAP2444	1
19	DOOR HINGE	SAP24154	2
21	SPEAKER	SAP2416	2
22	THERMOSTAT WIRE	SAP25314	1
24	INTERIOR LIGHT BULB	SAP2404	1
24	LIGHT HOUSING	SAP2606	1
25	POWER SUPPLY BOX	SAP24071	1
25	POWER SUPPLY RECEPTACLE	SAP24073	1
25	HEATER CIRCUIT BOARD	SAP2428	1
25	20 AMP OVERCURRENT PROTECTOR	SAP2529	1
26	STEREO SHELF	SAP24024	1
28	PANEL HEATER COVER	SAP3126	1
29	BACKREST	SAP2412	1
30	350W HEATER ELEMENT – BACK HEATER	SAP2423	2
30	350W HEATER ELEMENT – BENCH HEATER	SAP2423	1
31	2" (50mm) SCREW	SAP2411	2
31	1-1/2" (40mm) SCREW	SAP2411	4
31	1-1/8" (30mm) SCREW	SAP2411	8
31	3/4" (20mm) SCREW	SAP2411	18
---	BUCKLE	SAP2607	12
---	WOODEN POWER CABLE COVER	SAP3128	1
---	CONTROL PANEL WIRE (SHORT)	SAP2536	1
---	CONTROL PANEL WIRE (LONG)	SAP25361	1

Please see drawing on next page to assist in identifying parts.

SA2400

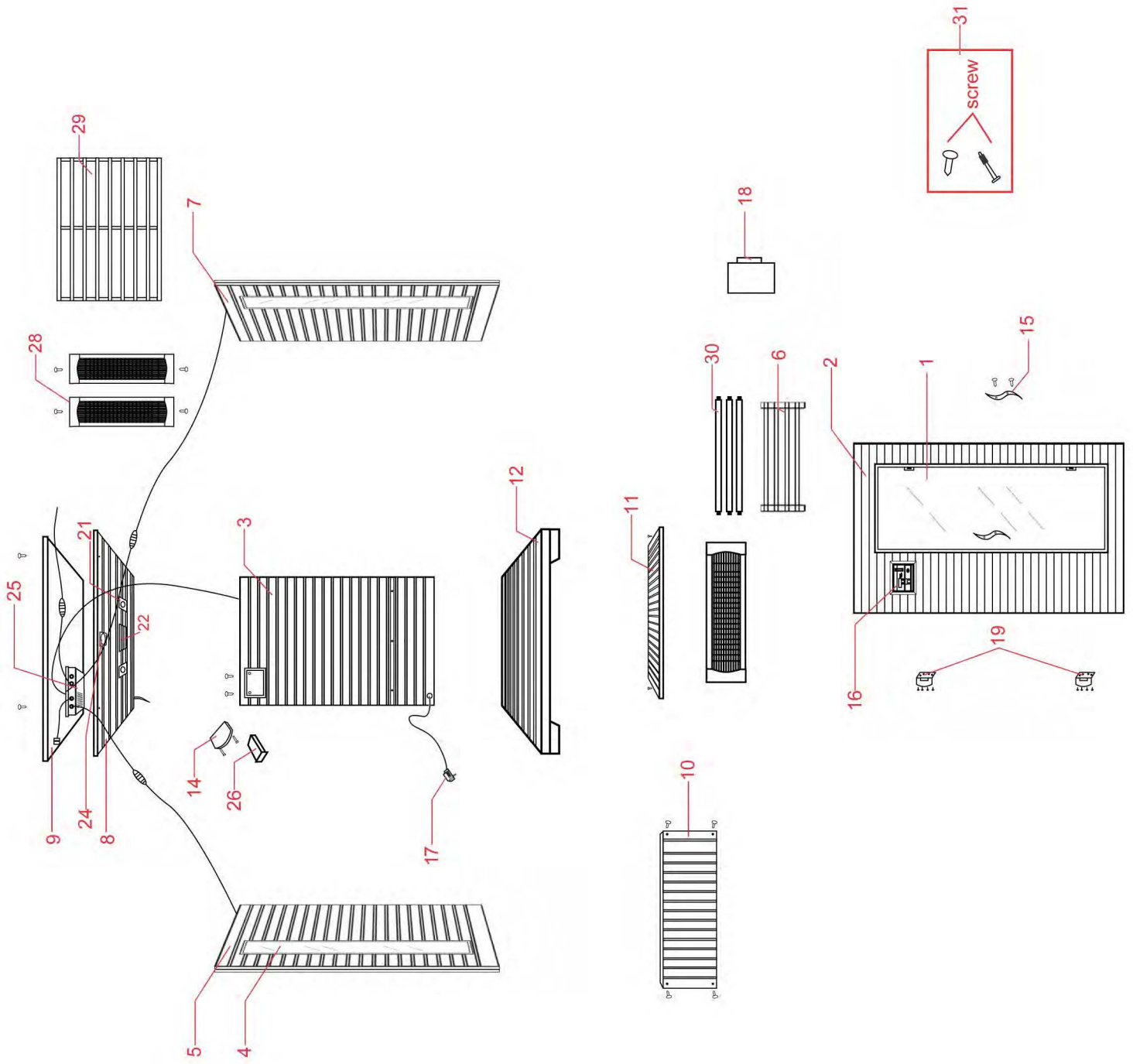

REPLACEMENT PARTS

Rev. 5/16

SA2406 TWO-PERSON HEMLOCK SAUNA WITH CERAMIC HEATERS

REF. #	DESCRIPTION	PART NUMBER	QTY.
1	GLASS DOOR	SAP24574	1
1	GLASS CLIP - METAL	SAP2537	2
1	DOOR MAGNET	SAP25371	2
2	FRONT PANEL with GLASS DOOR	SAP26294	1
3	BACK PANEL	SAP26323	1
5	LEFT PANEL	SAP2630	1
6	350W HEATER ELEMENT – BACK PANEL	SAP2423	2
7	RIGHT PANEL	SAP2631	1
8	ROOF	SAP26335	1
9	ROOF COVER	SAP2609	1
10	BENCH HEATER PANEL	SAP2635	1
11	BENCH SEAT	SAP2667	1
12	FLOOR	SAP2634	1
13	COLOR THERAPY LIGHT	SAP2410	1
14	AM/FM CD PLAYER with MP3 INPUT	SAP24085	1
15	DOOR HANDLE	SAP2413	1 SET
16	CONTROL PANEL	SAP2406	1
18	EXTERIOR LIGHT BULB	SAP2404	2
18,23	LIGHT HOUSING	SAP2606	4
19	DOOR HINGE	SAP24154	2
20	COLOR THERAPY CONTROL PANEL	SAP2427	1
20	COLOR THERAPY CONTROL PANEL FRAME	SAP2417	1
21	SPEAKER	SAP2416	2
22	THERMOSTAT WIRE	SAP25314	1
23	INTERIOR LIGHT BULB	SAP2404	2
24	MAIN POWER CABLE	SAP2703	1
25	POWER SUPPLY BOX	SAP24071	1
25	POWER SUPPLY RECEPTACLE	SAP24073	1
25	HEATER CIRCUIT BOARD	SAP2428	1
25	20 AMP OVERCURRENT PROTECTOR	SAP2529	1
26	STEREO SHELF	SAP24024	1
27	OXYGEN IONIZER	SAP2409	1
28	BACKREST	SAP2412	1
29	PANEL HEATER COVER	SAP3127	1
31	330W HEATER ELEMENT – LEFT PANEL	SAP2424	1
31	330W HEATER ELEMENT – RIGHT PANEL	SAP2424	1
31	330W HEATER ELEMENT – BENCH PANEL	SAP2424	1
32	DOUBLE TOWEL HOOK	SAP2460	1
33	MAGAZINE RACK	SAP2414	1
34	CUP HOLDER	SAP2444	2
35	2" (50mm) SCREW	SAP2411	6
35	1-1/2" (40mm) SCREW	SAP2411	4
35	1-1/8" (30mm) SCREW	SAP2411	6
35	3/4" (20mm) SCREW	SAP2411	24
---	BUCKLE	SAP2607	12
---	WOODEN POWER CABLE COVER	SAP3128	1
---	COLOR THERAPY CONTROL PANEL 4 PRONG WIRE	SAP2532	1
---	COLOR THERAPY CONTROL PANEL 5 PRONG WIRE	SAP2533	1
---	CONTROL PANEL WIRE (SHORT)	SAP2536	1
---	CONTROL PANEL WIRE (LONG)	SAP25361	1

Please see drawing on next page to assist in identifying parts.

SA2406

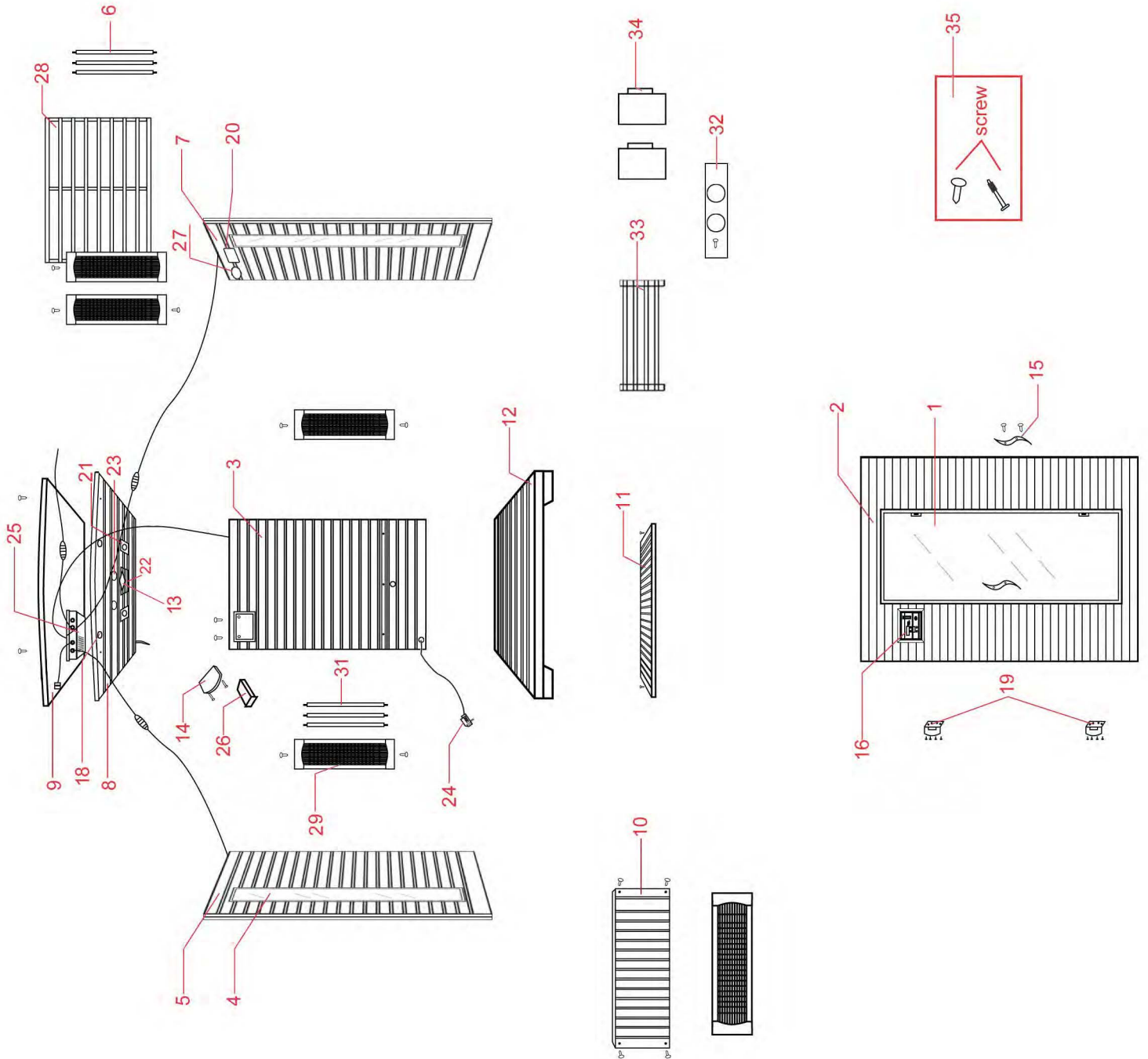

REPLACEMENT PARTS

Rev. 3/16

SA2409 TWO-PERSON HEMLOCK SAUNA WITH CARBON HEATERS

REF. #	DESCRIPTION	PART NUMBER	QTY.
1	GLASS DOOR	SAP24574	1
1	GLASS CLIP - METAL	SAP2537	2
1	DOOR MAGNET	SAP25371	2
2	FRONT PANEL with GLASS DOOR	SAP26364	1
3	BACK PANEL	SAP26394	1
5	LEFT PANEL	SAP26374	1
6	COLOR THERAPY CONTROL PANEL	SAP2427	1
6	COLOR THERAPY CONTROL PANEL FRAME	SAP2417	1
7	RIGHT PANEL	SAP26384	1
8	ROOF	SAP26405	1
9	ROOF COVER	SAP2609	1
10	BENCH HEATER PANEL	SAP26434	1
11	BENCH SEAT	SAP2454	1
12	FLOOR	SAP2641	1
13	BACKREST	SAP2412	2
14	AM/FM CD PLAYER with MP3 INPUT	SAP24085	1
15	DOOR HANDLE	SAP2413	1 SET
16	CONTROL PANEL	SAP2406	1
17	MAIN POWER CABLE	SAP2703	1
18	EXTERIOR LIGHT BULB	SAP2404	2
18,23	LIGHT HOUSING	SAP2606	4
19	DOOR HINGE	SAP24154	2
20	MAGAZINE RACK	SAP2414	1
21	SPEAKER	SAP2416	2
22	THERMOSTAT WIRE	SAP25314	1
23	INTERIOR LIGHT BULB	SAP2404	2
24,28	330W HEATER ELEMENT – BACK PANEL	SAP2418	2
24,28	330W HEATER ELEMENT – LEFT PANEL	SAP2418	1
24,28	330W HEATER ELEMENT – RIGHT PANEL	SAP2418	1
25	POWER SUPPLY BOX	SAP24071	1
25	POWER SUPPLY RECEPTACLE	SAP24073	1
25	HEATER CIRCUIT BOARD	SAP2428	1
25	20 AMP OVERCURRENT PROTECTOR	SAP2529	1
26	STEREO SHELF	SAP24024	1
27	CUP HOLDER	SAP2444	2
29	COLOR THERAPY LIGHT	SAP2410	1
30	DOUBLE TOWEL HOOK	SAP2460	1
31	FLOOR HEATER	SAP2642	1
32	225W HEATER ELEMENT – BENCH HEATER	SA92421	1
33	180W HEATER ELEMENT – FLOOR HEATER	SAP2419	1
34	OXYGEN IONIZER	SAP2409	1
35	2" (50mm) SCREW	SAP2411	4
35	1-1/2" (40mm) SCREW	SAP2411	10
35	1-1/8" (30mm) SCREW	SAP2411	6
35	3/4" (20mm) SCREW	SAP2411	24
---	BUCKLE	SAP2607	12
---	WOODEN POWER CABLE COVER	SAP3128	1
---	COLOR THERAPY CONTROL PANEL 4 PRONG WIRE	SAP2532	1
---	COLOR THERAPY CONTROL PANEL 5 PRONG WIRE	SAP2533	1
---	CONTROL PANEL WIRE (SHORT)	SAP2536	1
---	CONTROL PANEL WIRE (LONG)	SAP25361	1

Please see drawing on next page to assist in identifying parts.

SA2409

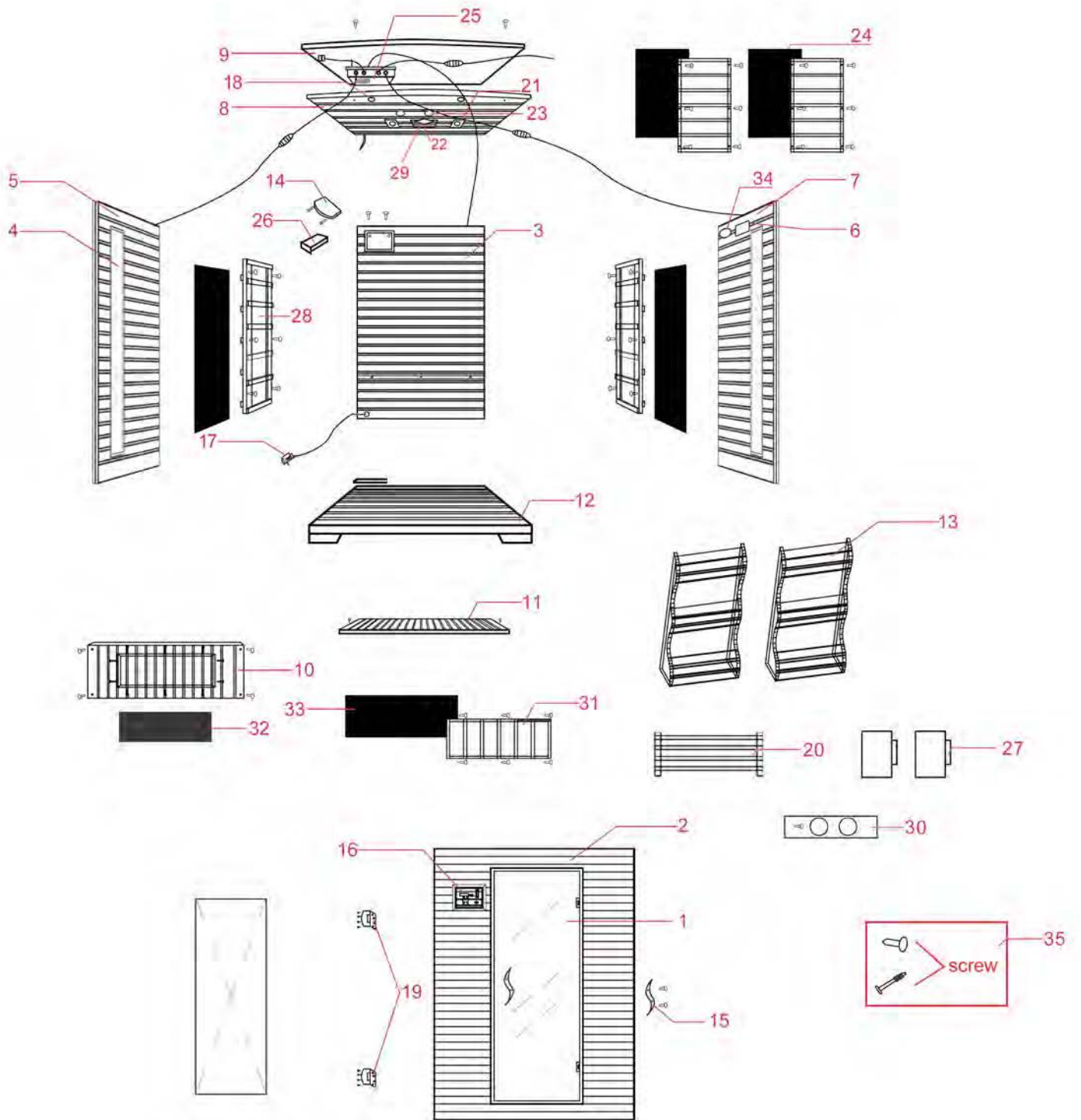

REPLACEMENT PARTS

Rev. 3/16

SA1309 TWO-PERSON CEDAR SAUNA WITH CARBON HEATERS

REF. #	DESCRIPTION	PART NUMBER	QTY.
1	GLASS DOOR	SAP24574	1
1	GLASS CLIP - METAL	SAP2537	2
1	DOOR MAGNET	SAP25371	2
2	FRONT PANEL with GLASS DOOR	SAP30004	1
3	BACK PANEL	SAP30034	1
5	LEFT PANEL	SAP30014	1
6	COLOR THERAPY CONTROL PANEL	SAP3112	1
6	COLOR THERAPY CONTROL PANEL FRAME	SAP3016	1
7	RIGHT PANEL	SAP30024	1
8	ROOF	SAP30045	1
9	ROOF COVER	SAP3005	1
10	BENCH HEATER PANEL	SAP30094	1
11	BENCH SEAT	SAP3008	1
12	FLOOR	SAP3006	1
13	BACKREST	SAP3010	2
14	AM/FM CD PLAYER with MP3 INPUT	SAP24085	1
15	DOOR HANDLE	SAP3011	1 SET
16	CONTROL PANEL	SAP2406	1
17	MAIN POWER CABLE	SAP2703	1
18	EXTERIOR LIGHT BULB	SAP2404	2
18,23	LIGHT HOUSING	SAP2606	4
19	DOOR HINGE	SAP24154	2
20	MAGAZINE RACK	SAP3014	1
21	SPEAKER	SAP2416	2
22	THERMOSTAT WIRE	SAP25314	1
23	INTERIOR LIGHT BULB	SAP2404	2
24,28	330W HEATER ELEMENT – BACK PANEL	SAP2418	2
24,28	330W HEATER ELEMENT – LEFT PANEL	SAP2418	1
24,28	330W HEATER ELEMENT – RIGHT PANEL	SAP2418	1
25	POWER SUPPLY BOX	SAP24071	1
25	POWER SUPPLY RECEPTACLE	SAP24073	1
25	HEATER CIRCUIT BOARD	SAP2428	1
25	20 AMP OVERCURRENT PROTECTOR	SAP2529	1
26	STEREO SHELF	SAP30124	1
27	CUP HOLDER	SAP3013	2
29	COLOR THERAPY LIGHT	SAP2410	1
30	DOUBLE TOWEL HOOK	SAP3015	1
31	FLOOR HEATER	SAP3007	1
32	225W HEATER ELEMENT – BENCH HEATER	SAP2421	1
33	180W HEATER ELEMENT – FLOOR HEATER	SAP2419	1
34	OXYGEN IONIZER	SAP2409	1
35	2" (50mm) SCREW	SAP2411	4
35	1-1/2" (40mm) SCREW	SAP2411	10
35	1-1/8" (30mm) SCREW	SAP2411	6
35	3/4" (20mm) SCREW	SAP2411	24
---	BUCKLE	SAP2607	12
---	WOODEN POWER CABLE COVER	SAP3128	1
---	COLOR THERAPY CONTROL PANEL 4 PRONG WIRE	SAP2532	1
---	COLOR THERAPY CONTROL PANEL 5 PRONG WIRE	SAP2533	1
---	CONTROL PANEL WIRE (SHORT)	SAP2536	1
---	CONTROL PANEL WIRE (LONG)	SAP25361	1

Please see drawing on next page to assist in identifying parts.

SA1309

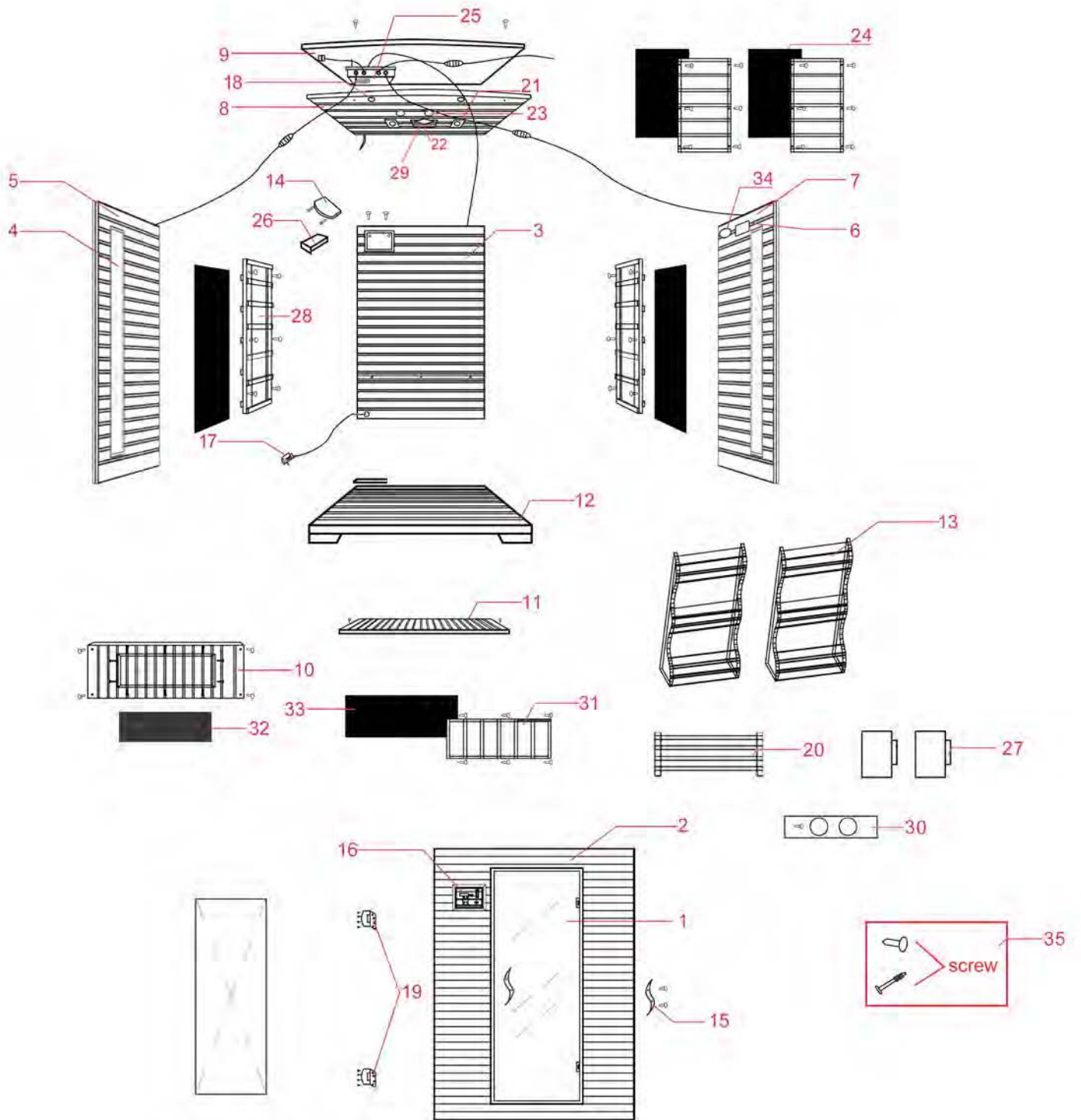

SAUNA WARRANTY REGISTRATION CARD

1. This sauna has a 7-Year Limited Warranty against defects in materials and workmanship from date of purchase. To receive the warranty, the card below must be filled out completely and returned within thirty (30) days from date of purchase. This 7-Year Limited Warranty covers the wood structure*. Heating elements and all electronics are covered by a 5-Year Limited Warranty. The radio/CD player (if included with your sauna) is covered by a limited 1-Year Warranty. The light bulbs are covered for 90 days.
2. This product is intended to be utilized for **private, non-commercial use**. Blue Wave Products sauna must be used as directed in the Product Operation Manual. Utilization of **non**-Blue Wave replacement parts or repairs which are not done by or under the direction of Blue Wave Products, Inc. shall also void any warranties/guarantees, expressed or implied.
3. This warranty does **not** cover defects or damage due to improper installation, alteration, accident, installation of unauthorized parts or any other event beyond the control of the Blue Wave Products. Defects or damage resulting from misuse, abuse or negligence will void this warranty. This warranty does **not** cover scratching or damage that may result from normal usage.
4. Please notify Blue Wave Products in advance of any sauna warranty claim prior to shipping the sauna back. Contact our warranty claim department at warranty@splashnetxpress.com. This warranty becomes valid at time of purchase and terminates either by specified time frame listed above, owner transfer, or relocation.
5. This warranty is nontransferable and is expressly limited to the repair or replacement of the defective product. During the warranty period, Blue Wave Products shall repair or replace defective parts at no cost to the purchaser. Shipping charges and insurance are **not** covered and are the responsibility of the purchaser. Labor charges and related expenses for removal, installation or replacement of the product or components are **not** covered under this warranty.
6. If the warranty claim department determines that the item must be returned, it must be returned with freight prepaid and a receipt showing date of purchase, purchase price, and the dealer from which the sauna was purchased. **No warranty claim will be honored without a receipt.**
7. Warranty claims will only be resolved with the repair of the current product, or shipment of a replacement product or parts at the sole discretion of Blue Wave Products. **NO REFUNDS** will be given.
8. Blue Wave Products reserves the right to make substitutions to warranty claims if parts are unavailable or obsolete.
9. Blue Wave Products shall **not** be liable for loss of use of the product or other consequential or incidental costs, expenses or damages incurred by the consumer of any other use. The user assumes all risk of injury resulting from the use of this product.
10. Improper installation, misuse or damages resulting from acts of nature will render this warranty null and void.
11. This warranty is in lieu of all other warranties expressed or implied and no responsibility is assumed for future damage due to misuse. This sauna is intended for **INDOOR USE ONLY**– outdoor installation of the sauna **WILL VOID THE WARRANTY**. Additional actions that will void the warranty are: Use of lacquer or paints on any part of the sauna, placing sauna on non-approved surface, and outdoor applications.

**Surface cracks are NOT considered defects in material or workmanship, as they are normal characteristics of all wood. This includes minor cracks due to wood expansion and contraction. Note: since the wood used in construction has been kiln dried, a certain amount of expansion and contraction is expected in the wood within a sauna environment. Also, over time the sauna wood may darken or change color tones. This color change is considered normal aging and is not covered under warranty.*

To send in this warranty card:
Fill out below, detach and mail
to the following address:

BLUE WAVE PRODUCTS
1745 Wallace Ave. Suite B
St. Charles, IL 60174

For further warranty information
or inquiries, please call 800-759-0977

Detach Here

Detach Here

SAUNA WARRANTY REGISTRATION FORM

Date Purchased: ____/____/____

Name: _____

Address: _____

City/State/Zip: _____

Phone: () _____ Email: _____

Purchased from: _____

Item Number: _____ Purchase Price: _____

To ensure product warranty, complete all information and mail this card within 30 days of purchase.